

Prepared for:



Cape Elizabeth Schools

320 Ocean House Road

Cape Elizabeth, ME 04107

Cape Elizabeth Schools Needs Assessment Report

FINAL SUBMISSION

October 22, 2019



TABLE OF CONTENTS

1.0 INTRODUCTION..... 3

 1.1 School Revolving Renovation Fund 4

2.0 POND COVE ELEMENTARY AND MIDDLE SCHOOLS..... 5

 2.1 Architectural..... 5

 2.2 Structural 7

 2.3 Plumbing 7

 2.4 Mechanical 8

 2.5 Electrical 9

 2.6 Fire Alarm 10

 2.7 Civil..... 10

3.0 HIGH SCHOOL..... 12

 3.1 Architectural..... 12

 3.2 Structural 12

 3.3 Plumbing 14

 3.4 Mechanical 15

 3.5 Electrical 15

 3.6 Fire Alarm 16

 3.7 Civil..... 16

APPENDICES

- Appendix A** Data Sheets
- Appendix B** Site Photos
- Appendix C** Questionnaire Results
- Appendix D** Cost Data
- Appendix E** Plumbing Code Requirements
- Appendix F** Existing Diagrammatic Floorplans
- Appendix G** Neighboring District Comparisons

1.0 INTRODUCTION

Colby Company (CCE) and Scott Simons Architects (SSA) have prepared this Needs Assessment Report for the Town of Cape Elizabeth School System. The objective of this report is to provide technical recommendations for capital improvements for each of the three schools. This report also includes the evaluation of the existing facilities and identification of any modifications required based on the capacity, condition, or impacts anticipated by any future capital improvement project.

The overall goal of this Needs Assessment Report is to provide a detailed technical resource for the Town of Cape Elizabeth School System to accurately address immediate and future capital improvement projects. These recommendations have been compiled from field investigations conducted by Colby Company and Scott Simons Architects, as well as feedback from teachers and staff at all three schools. All recommendations are captured in a datasheet in Appendix A and are based on a low, intermediate, and critical priority classification.

After this report has been published, a Building Committee will be established to review and determine a course of action regarding any potential renovations or new building construction. The results of the Building Committee Review will be summarized in a recommendation to the School Board.

This deliverable constitutes the Needs Assessment Report. Included in this report are:

- Detailed analysis of all three schools
- Appendix A – Datasheets identifying capital improvement projects that may be combined or addressed individually
- Appendix B – Existing site photographs to support the documentation
- Appendix C – Summarized questionnaire results from faculty and staff interviews conducted by Colby Company and Scott Simons Architects.
- Appendix D – Cost sheet calculator to assist with identifying budgetary costs for future capital improvement projects.
- Appendix E – Implications of Maine State Plumbing Code requirements triggered by major renovations.
- Appendix F – Existing diagrammatic floorplans used to assign room numbers to all spaces within all three schools. Please note: These floorplans should NOT be used for design until the measurements are field verified.
- Appendix G – Comparison of neighboring school districts with regard to renovations and new buildings.

1.1 School Revolving Renovation Fund

During the kickoff for this project, in July 2019 it was brought to the attention of Colby Company and Scott Simons Architects by Dr. Wolfrom that the State of Maine has available funds that are to be used for prioritized renovations for Maine schools. There is a total of \$25,000,000 available through an application process used by the State of Maine Office of School Facilities. These funds will be distributed based on the following categories:

- Priority 1 – Health, Safety, and Compliance Renovations
 - Roof Renovations
 - Indoor Air Quality
 - ADA Compliance
 - Hazardous Materials Abatement or Removal
- Priority 2 – Repairs and Improvements not Related to Health, Safety, and Compliance
 - Building Structures
 - Windows and Doors
 - Water and Septic Systems including Waste Disposal Systems
- Emergency – Unanticipated and sudden natural or human disaster, whether the facility has been declared uninhabitable by an authorized local, state, or federal agency, and whether the situation poses an imminent danger to the health and safety of students and staff. Currently there are no Emergency Category items in the Cape Elizabeth School system.

The State of Maine allows up to \$1,000,000 per priority, per building. After discussing with the Cape Elizabeth Project Team, Colby Company and Scott Simons Architects submitted SRRF applications in the hope of maximizing the amount of funds that Cape Elizabeth may be entitled to receive, within the time constraints dictated by the State of Maine.

Any funds awarded to the Cape Elizabeth School system must be used for the specified application indicated. The Cape Elizabeth School system will have to pay for the project upfront, and complete the project specified on the application by July 2021 in order to satisfy State of Maine funding requirements and receive reimbursement. This limits the scope of the applications to smaller, more realistic projects that can be completed by July 2021.

2.0 POND COVE ELEMENTARY AND MIDDLE SCHOOLS

2.1 Architectural

Overall Findings on the Condition of the School

Pond Cove Elementary School and the Middle School are physically connected as one building and will be considered as such in this report. The Elementary School has been designated into four areas for the purposes of this discussion: A, B, C and D. The Middle School area have been identified similarly, including D, E, F and G. These building blocks represent a variety of building construction blocks ranging from the original 1934 and 1948 buildings, with additions following in 1955, 1960, 1962, 1994 and 2004. The A, B and C blocks pertaining to the Elementary School largely correspond to the different classroom clusters reflecting the different age groups. Blocks E, F and G generally correspond to the different programmatic clusters within the Middle School program. Area D is the section which physically connects the Elementary School to the Middle School. It includes the main entry to both schools, as well as the Cafetorium, which is used by all students. Area D also houses the Pond Cove Elementary Gymnasium.

Area C and a portion of Area G, including the original 1934 building, are two and three stories respectively. The basement of Area G currently serves as back of house space and is not occupied by program. The balance of the building blocks are single-story structures. The 1934, 1948, 1955 and 1960 and 1962 additions are reported to have a composite wall assembly with a wood framed roof. Interior walls are a mix of CMU and wood stud wall assemblies. The 1994 and 2004 additions are steel framed with majority masonry veneer wall on the exterior. Area F has some masonry, but is mostly clapboard siding. Area E is also a combination of masonry and clapboard, with some upper wall portions having clapboard siding. Descriptions of the building systems can be found in the Structural, Mechanical, Plumbing, Electrical and Fire Alarm sections below.

Overall, the physical condition of all of the buildings, particularly given the age of some of them, is functionally satisfactory. This means that basic needs are met, but the building is not otherwise outstanding. The school has implemented a successful maintenance program that has served them well over the years. In this report, the design team has made an effort to differentiate such work items that can be categorized as maintenance items from items identified on Data Sheets as recommended candidates for Capital Improvement funding. Architectural Data Sheets focus on items related to Life Safety, Security, the Building Envelope integrity, and fundamental physical conditions. Specific areas of concern are the building envelope and thermal bridging, and underutilized space, specifically in the basement and courtyard of Area G. One critical work item the design team recommends be addressed immediately are the failing window sills, recorded on Data Sheet M-G-BE-2010.

Although the buildings have been relatively well kept, their overall appearance does reflect age. The interior CMU block walls, for instance, convey an institutional feel of a bygone era. This is an intangible characteristic that cannot be captured on a technical Data Sheet, but contributes greatly to the experience of the building. Information gained in this assessment pertaining to these types of items is included here.

In discussions with Faculty and Staff, it was shared that the facilities feel rundown. The CMU walls contribute to higher levels of noise and lack a feeling of comfort. Areas with inoperable windows also tend to make users feel they have less control over their space. In Area E in particular, there are a number of spaces that are internally located and have no windows, creating a lack of natural daylighting in those spaces. This is problematic in areas that are used as conference rooms, office spaces, or workrooms.

Though there appears to be a reasonable amount of dedicated storage throughout the building, faculty reported that storage was an issue, and that shelving and storage within the classroom spaces tended to be inadequate, or were not matched to their specific needs. In the Elementary School particularly, some noted that as storage spaces have been converted to programmed space over time, they have to utilize areas of the building farther away from their teaching spaces, or in some cases, incorporate items into their classroom and do without supplemental storage. In the Middle School, some felt that there was a shortage of teaching spaces, and indicated that the distance required to travel from classroom to classroom took up a significant amount of time

and energy. Some said that ‘satellite’ subjects, those where teachers travel to classrooms, were not able to be taught with the same richness they would be able to convey in a dedicated space.

Consideration of Facility Layout / Building Form

Given the organic growth of the facilities over time, and with most building blocks being a single story, the overall footprint of the school buildings is approximately 144,000 sf. This contributes to a high ratio of exterior building envelope to floor area. The Elementary School mostly follows a linear organizational pattern, running parallel to the adjacent Middle School, which is organized around more of a courtyard style organizational pattern. Due to grade changes across the site, Areas A and B are accessed one level above the main entrance. As noted above, the schools are connected by Wing D, which houses the Main Entrance, Cafetorium and Elementary School Gymnasium.

The Elementary School layout works well to compartmentalize the different classroom age groups and grades. Though the organization contributes to inefficiencies of adjacencies and requires very long paths of travel to the farther areas, particularly area A, which includes shared spaces such as the Media Center, Art, and Music Rooms. There is the question as to whether or not the isolation of each age group is beneficial; it may challenge the development of a cohesive culture within the Elementary School program overall.

The layout of the Middle School blocks alternately maximizes areas that are able to receive natural daylight by centralizing them around a courtyard which is otherwise underutilized and currently inaccessible. Wings D and F are aligned perpendicular to this configuration however, which contributes to inefficiencies of adjacencies similar to those in the Elementary School blocks and again requires very long paths of travel to the farther ends of each area, particularly Area G. Classrooms in Area G are the farthest distance possible from classroom located in Area E. Security implications related to Wing D are discussed below.

These configurations contribute to performance based operational inefficiencies of the building systems as well. Due to the various periods of construction, insulation and thermal properties of the wall conditions vary and are below what is currently considered good practice, though they may have met code requirements in place at the time of construction and renovation. The large amount of exterior surface area, including the walls and the roof, put a higher demand on the mechanical and plumbing systems due to the greater potential area contributing to thermal bridging and heat loss. There is also the challenge of having to provide for longer runs. See Mechanical, Electrical and Plumbing sections below. This greater square footage also directly translates to a more extensive maintenance need to keep the building envelope in good condition, though a well-pointed masonry wall is extremely durable and long-lasting.

Because of the building’s additive formation and the physical connection between the Schools, there are numerous potential points of entry associated with each wing. Aside from the main entrance, there are nearly 30 exterior doors shared between the two schools. Beyond being a maintenance item in terms of coordinating hardware maintenance and key access, these doors pose a potential security weakness. Should any of them be improperly propped open or left insecure, entrance could be gained to the entire facility. The current configuration is highly dependent on operational protocol being followed.

The Main Entrance itself presents a high security risk for both the Elementary and Middle Schools in the event of an intruder. Each school’s Main Offices is located a significant distance from the Main Entrance Doors, which leaves the main access point the building without direct supervision. From the Main Entrance doors, access can be gained directly to either the Elementary School Gymnasium or the shared Cafetorium space, where there is potential for a large number of students and faculty to be gathered at any given time.

This issue is one that cannot be remedied without renovation of or addition to the existing facility. Items like this are represented on Data Sheets with supporting plan diagrams to show what a potential design solution might comprise. These proposals are general in nature and if elected would require full development and exploration by an A/E team.

Life Cycle Cost and Other Considerations

When considering which items should be accepted, or whether or not continuing to improve and maintain the existing facilities is the best choice when weighed against the implication of constructing a new facility, the impact of Life Cycle Costs and recurring maintenance expenses must be considered. While this is not the purpose of this report, certain recommended work items will significantly alter maintenance costs or performance such as replacement of mechanical systems or VCT flooring. These items have the potential not only to improve the facilities, but in some cases, may provide a return on investment in maintenance and operations costs. In the case of the VCT flooring replacement, it's possible that reduced maintenance of new flooring could extend the use of the building and positively impact programming and availability to the community. The design team has made an effort to note situations like this on the Data Sheets where these types of considerations may be particularly impactful.

2.2 Structural

General

The original elementary/middle school building was constructed with composite brick exterior walls and interior CMU bearing walls. The building frame is wood construction with plaster surfaces that were repaired and repainted during a later renovation project. The gymnasium and locker room addition was added in 1962. This area has CMU bearing walls that were added for durability in the corridors, stairs, and other high use spaces. The foundation system consists of cast in place concrete footings with frost walls. Open web steel joists sit atop the bearing walls, supporting a 2" wood fiber plank with T-bulb framing or concrete plank deck. The concrete floor topping slabs are 2-1/2" thick with expanded metal lath. See the architectural section for information on the roofing materials.

Existing Conditions

The CMU walls appeared to be in good condition overall with minor cracks in the mortar joints between blocks. The southeast corner of the gymnasium has settled and there is a crack through the CMU blocks. The door on the south wall has been cut because it was difficult to open due to the settlement. CCE recommends adding epoxy-based repair mortar to this crack which will serve to repair it and allow it to be monitored to determine if this corner of the gym is still continuing to settle. If the repair mortar cracks, further investigation, and action will be required. Overall the structural system of the middle school is in good condition and does not require significant structural repairs or improvements.

2.3 Plumbing

Existing Conditions

Plumbing fixtures are generally commercial grade and aged but in serviceable condition. Some fixtures and other items such as floor drains have normal wear-and-tear type issues that need attention. Some fixtures lack ADA accessibility where it is required by current Codes and State standards, such as mounting height, piping protection in knee spaces, and flush valve handle location. Classroom sink bubblers are worn and need replacement. Emergency safety fixtures do not meet current Code and State standards requirements, in terms of quantities and locations as well as installation and water supplies and drains. Some sanitary vents through the roof are too close to ventilation air intakes. The domestic hot water supply includes high-efficiency gas-fired water heaters, and solar water heaters for added efficiency.

Plumbing Fixture Counts, General

The UPC 2015 (Uniform Plumbing Code, as adopted in the Maine Plumbing Code) lists requirements for quantities of several types of plumbing fixtures, based on the occupancy type. Occupants are presumed to be 50% female and 50% male for the purposes of this analysis. Appendix E of this report provides tables comparing the Code requirements to existing fixture quantities, and lists as deficiencies the quantities of additional fixtures that would be required to bring the schools up to current Code.

Fixture Counts, Pond Cove Elementary School

During educational occupancy hours, the analysis is based on an average of 630 students and 65 staff occupying the building. The analysis found deficiencies of staff fixture counts during educational hours.

During assembly occupancy hours, the Elementary School Gym occupancy is calculated as 4,277 square feet / 7 square feet per person = 611 people. The Cafetorium occupancy is calculated as 4,589 square feet / 7 square feet per person = 656 people. Due to corridor doors blocking access to the rest of the building, fixtures available would only be those nearby including rooms D105, D106, and the single-user ADA toilet at Corridor D100. The table in Appendix E examines scenarios with only the Gym or Cafetorium occupied individually, in which several additional plumbing fixtures are required. In a scenario with both the Gym and Cafetorium at these occupant counts, many additional plumbing fixtures are required. The requirements for additional drinking fountains are more fully described in an associated data sheet.

Fixture Counts, Middle School

During educational occupancy hours, the analysis is based on an average of 556 students and 95 staff occupying the building. The analysis found deficiencies of staff fixture counts during educational hours.

During assembly occupancy hours, the Middle School Gym occupancy is calculated as 7,517 square feet / 7 square feet per person = 1,074 people. The Cafetorium occupancy is calculated as 4,589 square feet / 7 square feet per person = 656 people. Due to corridor doors blocking access to the rest of the building, fixtures available would only be those nearby including rooms D105, D106, E114, E118, E123, E133, E136, E162, E168, E169, and the single-user ADA toilet at Corridor D100. The table in Appendix E examines a scenario with only Cafetorium occupied, with access to only the fixtures in rooms D105, D016, and the single-user ADA toilet; in this case several additional plumbing fixtures are required. In scenarios with only the Gym occupied and several toilet rooms available, or with both the Gym and Cafetorium at these occupant counts and all the toilet rooms listed above available, additional urinals would be required by UPC 2015, but there are extra male water closets that might be able to meet those needs.

Additional Fixtures Required Based on Fixture Counts in Elementary and Middle Schools

Whether the existing fixture quantities may be considered “grandfathered” is dependent on the scope and value of building renovations and repairs as defined by applicable Codes. The additional plumbing fixtures described above would be required if the selected work items for the building as a whole are determined to constitute substantial improvement as defined by IBC and IEBC 2015 (International Building Code, and International Existing Building Code). In general, substantial improvement is defined as improvements whose cumulative cost, within a particular time period, equal or exceed 50 percent of the market value of the structure before the improvement is started.

If these additional fixtures are required, working with an architect to determine and design spaces to locate additional fixtures is recommended. Therefore, the increase in plumbing fixtures is not included as a data sheet for the purposes of this project, as this scope item is highly dependent on which work items are selected.

2.4 Mechanical

Pond Cove Elementary School

Existing central systems for classroom areas generally consist of rooftop HRUs (heat recovery units) which supply air directly to the rooms, with hydronic (hot water) heating coils in the ducts to provide additional heat to the ventilation air and heating for the space; the HRUs also exhaust air from the classrooms and transfer that air’s heat to the incoming supply air. Administrative areas are served by a central AHU (air handling unit) which supplies air to the rooms through VAV (variable air volume) boxes, each of which has a hydronic heating coil. Other spaces have hydronic terminal heating units such as fin tube and cabinet unit heaters. Exhaust fans on the roof serve toilet rooms, janitor’s closets, and similar spaces.

Primary areas of concern are sufficiency of ventilation airflow rates (relative to Codes and ASHRAE standards) for indoor air quality, and age of existing central equipment. The rooftop HRUs (other than the Kindergarten

wing), exhaust fans, and some other equipment such as roof hoods are nearing or beyond their useful life expectancy and should be scheduled for replacement in the near future. Ventilation in corridors seems inadequate based on the small number and size of diffusers, and the diffusers are unevenly distributed. Central control systems are outdated Barber Colman Network 8000 type.

Please see the Data Sheets in Appendix A for more detail and recommendations about individual items.

Middle School

Existing central systems for classroom areas generally consist of rooftop HRUs and indoor central AHUs which supply air directly to the rooms, with hydronic heating coils in the ducts to provide additional heat to the ventilation air and heating for the space. Administrative areas are served by a central AHU which supplies air to the rooms through VAV boxes, each of which has a hydronic heating coil. Other spaces have hydronic terminal heating units such as fin-tube and cabinet unit heaters. Exhaust fans on the roof serve toilet rooms, janitor's closets, and similar spaces.

Primary areas of concern are sufficiency of ventilation for indoor air quality, and age of existing central equipment. The rooftop HRUs and exhaust fans, and some other equipment such as roof hoods are nearing or beyond their useful life expectancy and should be scheduled for replacement in the near future. Ventilation in corridors seems inadequate based on the small number and size of diffusers, and the diffusers are unevenly distributed. Locker room gas-fired RTUs (rooftop units) and associated exhaust fans and ductwork are fairly new and in good condition. Kitchen hood rooftop exhaust fan and makeup air unit are fairly new, but walk-in freezer and cooler rooftop condensing units are beyond their useful life expectancy and should be replaced. Some rooftop equipment lacks safe clearance to roof edges, or lacks good service access, which is further described in a Data Sheet in Appendix A. Central control systems are outdated Barber Colman Network 8000 type.

Please see the Data Sheets in Appendix A for more detail and recommendations about individual items.

2.5 Electrical

The existing electrical service to the building is via an exterior pad mounted transformer. The service is routed underground to a 1600 amp, 480/277 volt, 3 phase, 4 wire floor mounted main distribution panel (MDP). The MDP is located in the main electrical room. This switchboard feeds a 600 amp motor control center (MCC), and various distribution panelboards and step down transformers located throughout the facility. Most of the electrical equipment is 25 years old or more, but in good working condition. There are spares and spaces in the panels. In 2014 additional panels were added for the new boiler room and associated equipment. There is no meter on the equipment, so it is not clear if the service size is adequate for any additions/modifications. It is recommended a meter be placed on the building to determine usage.

Classrooms have a combination of surface mounted and recessed receptacles, indicating that additional receptacles have been added over time. The classrooms do not have dedicated circuits for laptop and/or tablet charging stations. Power strips were noted in many instances to increase the availability of receptacles.

The telephone system in the building is traditional analog phones, with connection a to the main office. The system is outdated, and it is recommended that it be upgraded to Voice over IP (VOIP). If the phones are updated/upgraded, it can be combined with an upgrade of the Public Address system (PA)/Intercom, using the phones and have an integrated system. The current PA system has older style speakers, and intelligibility is low.

The internet/data cabling throughout the facility has recently been updated to CAT6 cabling, and Wireless Access Points (WAP) are located throughout the building, in classrooms, offices, and multipurpose areas. Classrooms are equipped with digital overhead projectors that are aged. It is recommended the overhead projectors be replaced with smartboards to keep up with the growing technology. The entrance for the communications, phone and data is in a room that has plumbing running over the equipment which has the potential to cause damage to the equipment. There are five intermediate distribution frames (IDF) that are located throughout the facility but are not in dedicated equipment spaces.

The building is equipped with security cameras, some of which are connected back to the main server at the high school. Cameras are located throughout the facility in corridors and building entrances. Not all cameras are functional.

Lighting throughout the facility is a typically 2x4 T8 fluorescent fixtures in the classrooms, and library with local switching and no occupancy sensors. Classroom switching is a combination of 1, 2 or 3 switches per room, controlling the rows of lights. The corridor and office lighting are a combination of 2x2 and 2x4 fluorescent fixtures with keyed switches to prevent access, or accidental switching. The kitchen has lensed wrap fixtures, and the gymnasium has highbay T5 lighting with local switching. Without occupancy sensors, there is no automatic controls to reduce energy consumption with the lighting load. It is recommended that existing fluorescent fixtures be replaced with more energy efficient LED lighting, and locations that do not have occupancy sensors be upgraded to provide occupancy sensors for energy savings.

Emergency lighting throughout the building is accomplished with battery units with remote heads. The units are outdated, and in some instances were damaged. The single head units do not meet current code and should be replaced. Not all egress doors have an exterior mounted emergency light. Exit signs were noted throughout, and were internally lit, and in good condition.

2.6 Fire Protection

2.6.1 *Fire Sprinklers*

The Pond Cove Elementary and Middle Schools are protected throughout by automatic fire sprinkler systems. Multiple risers, both wet-pipe and dry-pipe, are located throughout the building in the respective area served by each.

Service labels located on the risers indicate that gauges were replaced and an internal inspection was performed by Eastern Fire Services Incorporated in 2018. These services are required to be performed on a 5-year interval per NFPA 25.

The building construction in some areas includes exposed wood and other combustible building materials. These materials create concealed combustible spaces above lay in ceilings which are protected with sprinklers as required by NFPA 13. Some areas were noted in which ductwork and other equipment installed above ceilings created obstructions to the installed sprinklers, it is recommended that noted areas be corrected and other above ceiling spaces be evaluated to ensure sprinkler coverage is in compliance with NFPA 13 in these above ceiling spaces.

No backflow prevention devices appear to be installed on any of the sprinkler risers, though some do have a single swing check valve installed.

Several areas were noted throughout the building where escutcheon plates were not installed on sprinklers as required by NFPA 13. Escutcheon plates are recommended to be installed at all sprinkler ceiling penetrations.

One area was noted in which electrical conduit was secured to fire sprinkler piping support which is not allowed by NFPA 13 without an engineering evaluation. Electrical and other equipment is recommended to be supported independently of the fire sprinkler system.

2.6.2 *Fire Alarm*

The Pond Cove Elementary and Middle Schools are served by a combined fire alarm and occupant notification system. The fire alarm system is based on a Siemens Firefinder XLS addressable control panel. Off premises signal transmission is via an AES IntelliNet mesh radio transceiver.

Alarm initiation is by spot smoke and heat detectors located in corridors and some common areas including some offices and classrooms, manual pull stations, and sprinkler waterflow. Duct smoke detectors are labeled as being configured as supervisory, non-alarm, signals per NFPA 72. Occupant notification is general alarm evacuation provided by horns and strobes.

The main fire alarm control panel is located in Area E in Storage Room E170. Text and graphic zone annunciators are located in Area D and Area F. No smoke detector was noted installed in the location of the control panel; it is recommended that smoke detection be installed at the location of all fire alarm control equipment in normally unoccupied areas as required by NFPA 72.

2.7 Civil

The Middle School and Pond Cove Elementary School share an exclusive bus drop off loop that is located centrally to the entrances of both schools. A separate driveway located off of Scott Dyer Road and west of the existing baseball field and playground is used to access the teacher parking areas and for parents to drop-off students. During morning drop-off, it is not uncommon for traffic to be backed up to Scott Dyer Road. In order to alleviate the traffic congestion, it would be necessary to either lengthen or re-configure the parking area to allow for a longer queue length (ability for cars to line up entirely within school property) without backing into Scott Dyer Road. Due to the proximity of the school, athletic field to the access road and the fact that the campus footprint is already maximized without encroaching into wetlands the reconfiguration of the parent drop-off and teacher parking would involve the loss of an athletic field or additional wetland fill.

3.0 HIGH SCHOOL

3.1 Architectural

Overall Findings on the Condition of the School

The High School has been designated into four areas for the purposes of this report: A, B, C and D. The adjoining Donald Richards Pool facility and addition is technically operated by the Town of Cape Elizabeth and was not included in this assessment. The original High School building was constructed in 1969 and has composite masonry bearing walls with precast articulated fenestration panels. Many of the interior walls are exposed CMU, both bearing and non-bearing, with some infilled metal stud walls added during a 2004 renovation. The school's program is distributed on three levels responding to the change in topography across the site. Areas A, C and D are mostly single story in height, with a portion of area A extending to all three levels. Descriptions of the building systems can be found in the Structural, Mechanical, Plumbing, Electrical and Fire Alarm sections below.

Overall, the physical condition of the building is satisfactory given its age. This means that basic needs are met, but the building is not otherwise outstanding. The school has implemented a successful maintenance program that has served them well over the years. In this report, the design team has made an effort to differentiate such work items that can be categorized as maintenance items from items identified on Data Sheets as recommended candidates for Capital Improvement funding. Architectural Data Sheets focus on items related to Life Safety, Security, the Building Envelope integrity, and fundamental physical conditions. Specific areas of concern for the High School are the building envelope, particularly failure of the cast stone window panels and failing windows throughout the school.

Although the building has been well kept, its overall appearance does reflect its age. The interior CMU block walls, for instance, convey an institutional feel of a bygone era. This is an intangible characteristic that cannot be captured on a technical Data Sheet, but contributes greatly to the experience of the building. Information gained in this assessment pertaining to these types of items are included here.

In discussions with Faculty and Staff, it was shared that the facility feels rundown and unwelcoming. The CMU walls contribute to higher levels of noise and lack a feeling of comfort. Over time, as the school program has grown, secondary spaces have been annexed for offices and other primary program spaces. Occupants in these areas do not have windows, or in some cases are not optimally located to the programs they serve. This is particularly problematic in areas that are used as conference rooms, office space, or workrooms. Notably, acoustical issues were reported in most areas. The design team has identified related work items and have provided suggestions in a few Data Sheets. For instance, walls should be continued to the deck between classrooms to reduce noise transfer as noted on Data Sheet H-ALL-A-4007.

One programmatic need that was repeatedly reported was one for a mid-sized lecture hall and meeting room. This, and other requests representing programmatic growth are unlikely to be remedied without renovation of or addition to the existing facility. Items like this are represented on Data Sheets with supporting plan diagrams to show what a potential design solution might comprise. Note that these proposals are general in nature and if elected would require full development and exploration by an A/E team.

The need for Gender Neutral restrooms was repeatedly mentioned during the faculty interviews. Deferring to the U.S. Department of Education's 2014 and 2015 findings that Title IX of the Education Amendment of 1972 extends to protect students from discrimination on the basis of gender identity, the Fourth Circuit U.S. Court of Appeals ruled in favor of a transgender student's right to use facilities consistent with his or her gender identity in 2016. U.S. Department of Labor's OSHA is also in agreement that employees should be permitted to use facilities corresponding to their gender identity. The Maine Human Rights Act also prohibits discrimination on the basis of sex, sexual orientation, gender identity or expression. In addition to typical male and female restrooms, single occupant restrooms may be provided and are commonly referred to as 'Gender Neutral' as an alternative to 'Unisex.' Alternately, completely divided, private toilet compartments may be provided in a commonly accessed restroom facility with a common sink area. Accommodations for each of these options have been investigated in Data Sheets for this report.

Consideration of Facility Layout / Building Form

Despite having three levels, the High School footprint is fairly extensive, with roughly half of the overall 165,300 sf area rambling as a single story on either side of main ‘spine’. This contributes to a higher ratio of exterior building envelope to floor area than a more compact building would have. With the Main Entry on the top-most level and the largest floor area coverage extending two levels below, the layout was often reported as being cumbersome and lengthy in terms of day to day occupant flow and circulation. This configuration contributes to performance based operational inefficiencies of the building systems as well. Due to the date of construction, insulation and thermal properties of the wall conditions are below what is currently considered good practice, though they may have met code requirements in place at the time of construction and renovation. The large amount of exterior surface area, including the walls and the roof, put a higher demand on the mechanical, electrical and plumbing systems due to the greater potential area contributing to thermal bridging and heat loss, as well as the challenge of having to provide for multi-directional runs. See Mechanical, Electrical and Plumbing sections below. This amount of exterior square footage also directly translates to a more extensive maintenance need to keep the building envelope in good condition, though a well-pointed masonry wall is extremely durable and long-lasting. There is a current maintenance program for window replacement and much of this work has already been done. The urgency of the related failing sill conditions, however, is still a priority.

Because of the building’s layout there are numerous potential points of entry associated with each wing and egress stair. This was reported as a challenge to the current security protocol requiring occupants and visitors to enter at the Main Entrance only. Given that the distance is so great from some exit locations, some of those doors are sometimes propped open to avoid having to go around in order to re-enter the building. These locations are potential security weaknesses as entrance could be gained to the entire facility at these points. The current system is highly dependent on operational protocol being observed and followed.

Life Cycle Cost and Other Considerations

When considering which items should be accepted, or whether or not continuing to improve and maintain the existing facility is the best choice when weighed against the implication of constructing a new facility, the impact of Life Cycle Costs and recurring maintenance expenses must be considered. While this is not the purpose of this report, certain recommended work items will significantly alter maintenance costs or performance such as replacement of mechanical systems or VCT flooring. These items have the potential not only to improve the facilities, but in some cases, may provide a return on investment in maintenance and operations costs. In the case of the VCT flooring replacement, it’s possible that reduced maintenance of new flooring could extend the use of the building and positively impact programming and availability to the community. The design team has made an effort to note situations like this on the Data Sheets where these types of considerations may be particularly impactful.

Structural

General

The High School was originally constructed in 1969. It consists of a composite of brick and CMU bearing/shear walls with a brick veneer. There are concrete window infill panels with rigid insulation and drywall on the interior. The interior corridors have CMU bearing walls on either side. The foundation system consists of cast in place concrete footings with frost walls. Open web steel joists sit atop the bearing walls, supporting a 2” wood fiber plank with T-bulb framing or concrete plank deck. The concrete floor slabs are 2-1/2” thick with expanded metal lath. See the architectural section for information on the roofing materials.

The High School was renovated in 2004. These renovations included the addition of the main entrance and interior upgrades. The interior upgrades consisted of new gypsum walls, the addition of ACT ceiling tiles, and other architectural upgrades and mechanical.

Existing Conditions

The CMU walls appeared to be in good condition with minor cracks in the mortar seams between blocks. There were no visible signs of settlement or concerning damage to the bearing walls throughout the school. Roof area A cannot currently withstand the ASCE prescribed snow load and therefore the open web joists will need to be reinforced throughout this area to increase the roof's loading capacity. Please refer to the appropriate datasheet for more design information regarding the roof reinforcement. Overall the structural system of the high school is in good condition and does not require significant repairs or improvements.

3.2 Plumbing*Existing Conditions*

Plumbing fixtures are generally commercial grade and aged but in serviceable condition. Some fixtures and other items such as floor drains have normal wear-and-tear type issues that need attention. Some fixtures lack ADA accessibility where it is required by current Codes and State standards, such as mounting height, piping protection in knee spaces, and flush valve handle location. Emergency safety fixtures do not meet current Code and State standards requirements, in terms of quantities and locations as well as installation and water supplies and drains. The domestic hot water supply includes a large elevated tank which is heated by the oil-fired central heating boilers, and solar water heaters for added efficiency; the elevated tank needs replacement due to age and leaks. Some of the roof drains are low-cost retrofit adapter type installed by roofers, and should be replaced with commercial-grade drains.

Fixture Counts

The UPC 2015 (Uniform Plumbing Code, as adopted in the Maine Plumbing Code) lists requirements for quantities of several types of plumbing fixtures, based on the occupancy type. Occupants are presumed to be 50% female and 50% male for the purposes of this analysis. Appendix E of this report provides tables comparing the Code requirements to existing fixture quantities, and lists the quantities of additional fixtures that would be required to bring the schools up to current Code.

During educational occupancy hours, the analysis is based on an average of 518 students and 110 staff occupying the building. The analysis found deficiencies of staff fixture counts during educational hours.

During assembly occupancy hours, the High School Gym occupancy is calculated as 13,027 square feet / 7 square feet per person = 1,074 people. The Auditorium occupancy is calculated as 500 seats + 15 stage performers = 515 people. Due to corridor doors blocking access to the rest of the building, fixtures available would only be those nearby including rooms C119, C122, D116, D117, A104, A106, D127, and D128. The table in Appendix E examines a scenario with only the Gym occupied and only toilet rooms D116, D117, A106, A106, D127, and D128 available, in which case several additional fixtures are required. In a scenario with only the Auditorium occupied and only toilet rooms A104, A106, C119, and C122 available, an additional male water closet required. In a scenario with both the Gym and Auditorium at these occupant counts and all the toilet rooms listed above available, several additional fixtures are required. The requirements for additional drinking fountains are more fully described in an associated data sheet.

Additional Fixtures Required Based on Fixture Counts

Whether the existing fixture quantities may be considered "grandfathered" is dependent on the scope and value of building renovations and repairs as defined by applicable Codes. The additional plumbing fixtures described above would be required if the selected work items for the building as a whole are determined to constitute substantial improvement as defined by IBC and IEBC 2015 (International Building Code, and International Existing Building Code). In general, substantial improvement is defined as improvements whose cumulative cost, within a particular time period, equal or exceed 50 percent of the market value of the structure before the improvement is started.

If these additional fixtures are required, working with an architect to determine and design spaces to locate additional fixtures is recommended. Therefore, the increase in plumbing fixtures is not included as a data sheet for the purposes of this project, as this scope item is highly dependent on which work items are selected.

3.3 Mechanical

General

Existing systems for classrooms generally consist of UVs (unit ventilators) located in the room, with louvers in the outside wall to provide fresh air, relief grilles to allow the UVs' outside air to relieve to the outdoors, and hydronic (hot water) coils in the UVs. Central systems for other areas generally consist of indoor central AHUs (air handling units) which supply air directly to the rooms, with hydronic heating coils in the ducts to provide additional heat to the ventilation air and heating for the space. Administrative areas are served by a central AHU which supplies air to the rooms through VAV (variable air volume) boxes, each of which has a hydronic heating coil. Other spaces have hydronic terminal heating units such as fintube and cabinet unit heaters. Exhaust fans on the roof serve toilet rooms, janitor's closets, and similar spaces.

Primary areas of concern are sufficiency of ventilation airflow rates (relative to Codes and ASHRAE standards) for indoor air quality, and age of existing central equipment. The UVs are of various ages, many being well beyond their usable life. Ventilation in corridors seems inadequate based on the small number and size of diffusers, and unevenly distributed. A few rooms have had a change of use, have been altered, or were added within existing spaces, without providing proper mechanical ventilation and other services. The Auditorium central air handling system does not provide good air distribution and ventilation effectiveness. The nurse's area lacks ventilation. Gymnasium gas-fired RTU (rooftop unit) air handlers and associated ductwork are fairly new and in good condition. The school's locker rooms share ventilation systems with the adjacent community pool's locker rooms, allowing pool odors into the High School's locker rooms. Few spaces have air conditioning (primarily those with extensive computer use), though many more rooms are used for summer school. Exterior components such as wall louvers are damaged due to student activity, vandalism, or other impact. Some rooftop equipment lacks safe clearance to roof edges, or lacks good service access, which is further described in a Data Sheet in Appendix A. Central control systems are outdated Barber Colman Network 8000 type.

Please see the Data Sheets in Appendix A for more detail and recommendations about individual items.

3.4 Electrical

The existing electrical service to the building is via an exterior pad mounted transformer. The service is routed underground to a 2000 amp, 120/208 volt, 3 phase, 4 wire floor mounted main distribution panel (MDP). The MDP is located in the main electrical room. This switchboard feeds various distribution panelboards located throughout the facility. Most of the electrical equipment is original, but in good working condition. There are limited to no spares and spaces in the panels. If additional circuits are to be added, additional panels will be required. There is no meter on the equipment, so it is not clear if the service size is adequate for any additions/modifications. It is recommended a meter be placed on the building to determine usage.

Typically, wire is run in conduit, and mc-cable run in walls and above ceilings. It was noted that NM (Non-metallic) wiring is above the suspended ceiling. This is not code compliant, and should be replaced.

Classrooms have a combination of surface mounted and recessed receptacles, indicating that additional receptacles have been added over time. The classrooms do not have dedicated circuits for laptop and/or tablet charging stations. Power strips were noted in many instances to increase the availability of receptacles.

The telephone system in the building is traditional analog phones, with a connection to the main office. The system is outdated, and it is recommended that it be upgraded to Voice over IP (VOIP). If the phones are updated/upgraded, it can be combined with an upgrade of the Public Address system (PA)/Intercom, using the phones and have an integrated system. The current PA system has older style speakers, and intelligibility is low.

The CAT6 wiring throughout the facility has recently been updated, and Wireless Access Points (WAP) are located throughout the building, in classrooms, offices, and multipurpose areas. Classrooms are equipped with

digital overhead projectors that are aged. It is recommended the projectors be replaced with smartboards to keep up with the growing technology. The data equipment is kept in a clean, dry, dedicated space.

The building is equipped with security cameras, some of which are connected back to the main server which is located in the data room in this building. Other cameras are not functional. This server also connects to the other school, and municipal buildings in town. Cameras are located throughout the facility in corridors and building entrances.

Lighting throughout the facility are typically 2x4 LED fixtures in the classrooms, and library with local switching and occupancy sensors. The corridor and office lighting are a combination of 2x2 and 2x4 fluorescent fixtures with keyed switches to prevent access, or accidental switching. The kitchen has lensed wrap fixtures, and the gymnasium has highbay LED lighting with local switching. Without occupancy sensors, there is no automatic controls to reduce energy consumption with the lighting load. It is recommended that existing fluorescent fixtures be replaced with more energy efficient LED lighting, and locations that do not have occupancy sensors be upgraded to provide occupancy sensors for energy savings.

Emergency lighting throughout the building is accomplished with battery units with remote heads. The units are outdated, and in some instances were damaged. The single head units do not meet current code and should be replaced. Not all egress doors have an exterior mounted emergency light. Exit signs were noted throughout, and were internally lit, and in good condition.

3.5 Fire Protection

3.5.1 *Fire Sprinklers*

The Cape Elizabeth High School is protected throughout by automatic fire sprinkler systems with the exception of the pool area addition. Multiple wet-pipe risers are located throughout the building in the respective area served by each.

Service labels located on the risers indicate that gauges were replaced and an internal inspection was performed by Eastern Fire Services Incorporated in 2018. These services are required to be performed on a 5-year interval per NFPA 25.

The addition to the building with including the swimming pool, fitness area, and associated locker rooms do not have automatic sprinkler systems or other fire suppression provided. These areas of the building are not separated by a fire wall; therefore, the entire building is not considered to be protected throughout. It is recommended that an automatic sprinkler system be installed for protection of these areas.

A backflow prevention device is installed at what appears to be the main sprinkler water entrance in the second-floor mechanical room.

3.5.2 *Fire Alarm*

The Cape Elizabeth High School is served by a fire alarm and occupant notification system. The fire alarm system is based on a Siemens Firefinder XLS addressable control panel. Off premises signal transmission is via an AES IntelliNet mesh radio transceiver.

Alarm initiation is by spot smoke and heat detectors located in corridors and common areas including some offices and classrooms, manual pull stations, and sprinkler waterflow.

Audible occupant notification appears to be provided by both horns and speakers in different areas of the building. In addition, there appear to be two separate voice evacuation systems, one based on a Notifier VEC 25/50 panel and the other on a Wheelock SafePath panel. The Notifier panel is labeled as serving the pool area and the Wheelock panel is not labeled, the actual areas of coverage were not determined. It is recommended that

the occupant notification be combined from the three existing systems to a single system throughout the entire building.

The main fire alarm control panel and voice evacuation control panels are located in the corridor adjacent to the maintenance office. Notification Appliance Circuit expander panels were noted in unoccupied areas such as Electrical Closet D115 which did not have smoke detection installed. It is recommended that smoke detection be installed at the location of all fire alarm control equipment in normally unoccupied areas as required by NFPA 72.

The annual fire alarm inspection report from 2018 notes that audible notification in some areas of the building are a constant tone horn instead of the temporal-3 evacuation signal used in most areas of the building and is recommended to be consistent throughout the building. The existing notification appliance horns are capable of producing the temporal-3 signal via a configuration switch setting and may require the installation of a synchronization module at the location of the notification appliance circuit panel.

3.6 Civil

The High School is currently served by a single driveway that teachers, students and buses share. In the morning though busy there does not appear to be a significant issue with traffic congestion. However, in the afternoon, the bus queues at the High School block students exiting to cars in the parking area. During dismissal there is conflict between students crossing in front of and behind the queued buses. Since there is only one entrance/exit road for the High School there is conflict between the buses and student operated cars. This is a safety concern as many students try to “make a run for it” as buses depart the school to beat the buses out of the driveway so they don’t have to wait at the intersection with the High School and Ocean House Road.

This existing conflict could be eliminated with a separate bus exit onto Ocean House Road. The High School Property is shaped in such a manner that a 20-foot strip of land exists between Tax Maps U21-17 and U21-16 & 16A. This strip is contiguous with the High School property and would allow room to construct a 12-foot-wide exit lane for buses only. Additionally, a timed signal could be added at the intersection of this Bus Exit Lane and Ocean House Road such that it only operates when school is in session and only during the 10-minute window when buses are exiting the high school. At all other times this access would be gated and locked.

APPENDIX A - DATASHEETS



47A York St
 Portland, ME 04101
 colbycoengineering.com

75 York St
 Portland, ME 04101
 simonsarchitects.com



Appendix A – Datasheets

Code Lookup/Legend

Example: H-320-A-4030 (Science Rooms: Improvements)

<u>School Code</u>	<u>Location</u>	<u>Discipline</u>	<u>Item Number</u>
H	320	A	4030
E – Elementary School M – Middle School EM – Elementary & Middle School H – High School	Room Number, OR ALL – All buildings, NEW – New buildout, EXT – Exterior, ROOF – Roof	A – Architectural BE – Building Envelope C – Civil/Landscape E – Electrical FP – Fire Protection LS – Life Safety M – Mechanical P – Plumbing S – Structural SC – Security	This Item Number is used to catalog work items sequentially by school: 1### – Elementary 2### – Middle 3### – Elementary and Middle 4### – High

Priority Codes

Red	Work item will need to be addressed within the next 0-3 years
Yellow	Work item will need to be addressed within the next 3-5 years
Green	Work item will need to be addressed within the next 5-10 years

Cost Codes

\$ = \$1 through \$10,000
 \$\$ = \$10,001 through \$50,000
 \$\$\$ = \$50,001 through \$100,000
 \$\$\$\$ = \$100,001 and higher

Note: All priority codes assigned have been based on detailed field investigations conducted between July 2019 and August 2019 by Colby Company, LLC and Scott Simons Architects. The information analyzed is based on current, existing conditions observed.

Gym Flooring Damage & Safety

RELATED SCOPES OF WORK
Not Applicable

E-D102-A-1002				
Priority		Cost		
		\$\$\$		
Coordination by Discipline				
<input checked="" type="checkbox"/>	<input type="checkbox"/>	<input type="checkbox"/>	<input type="checkbox"/>	<input type="checkbox"/>
A	M	E	P	FP
<input type="checkbox"/>	<input type="checkbox"/>	<input type="checkbox"/>	<input type="checkbox"/>	<input type="checkbox"/>
S	LS	SC	BE	C

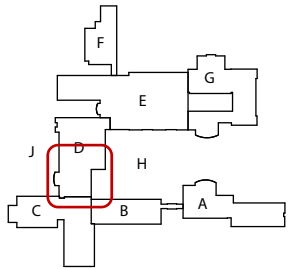

EXISTING CONDITIONS

- a. Bubbling evident in the Pond Cove Gymnasium sheet flooring. It is assumed the flooring is original to the 1994 construction. Perimeter of sports flooring has a non-vented rubber base
- b. Due to the age of the sports flooring, it is assumed to be a sheet product glued directly to the concrete slab. This product provides very little protection in the event of a fall.

RECOMMENDATIONS

- a. Flooring should be replaced with a new sports flooring with a Class 3 or better force reduction factor. In addition to having a much higher safety factor, the foam backing provides acoustical properties. Consult with manufacturer to see if a vented base with vented underlayment would be a benefit in addressing bubbling.

Media Center Improvements

RELATED SCOPES OF WORK
E-ALL-A-3002

E-105-A-1005				
Priority		Cost		
		\$		
Coordination by Discipline				
<input checked="" type="checkbox"/>	<input checked="" type="checkbox"/>	<input checked="" type="checkbox"/>	<input type="checkbox"/>	<input type="checkbox"/>
A	M	E	P	FP
<input type="checkbox"/>	<input type="checkbox"/>	<input type="checkbox"/>	<input type="checkbox"/>	<input type="checkbox"/>
S	LS	SC	BE	C

EXISTING CONDITIONS

- a. Although well maintained, millwork seating is showing standard wear and tear and does not allow for flexibility in usage.



RECOMMENDATIONS

- a. At a minimum, re-upholster existing components with new commercial grade fabric with required flame spread rating.
- b. Consider removing the millwork entirely and replacing with modular soft seating that allows for class gatherings but that can be rearranged to allow for variance in accommodation and use.
- c. Verify whether carpeting continues below existing millwork. Patch locally if existing finished flooring will remain.

Wall Repair: Stress Cracks

RELATED SCOPES OF WORK
Not Applicable

E-ALL-A-1006				
Priority	Cost			
	\$			
Coordination by Discipline				
<input checked="" type="checkbox"/>	<input type="checkbox"/>	<input type="checkbox"/>	<input type="checkbox"/>	<input type="checkbox"/>
A	M	E	P	FP
<input checked="" type="checkbox"/>	<input type="checkbox"/>	<input type="checkbox"/>	<input type="checkbox"/>	<input type="checkbox"/>
S	LS	SC	BE	C

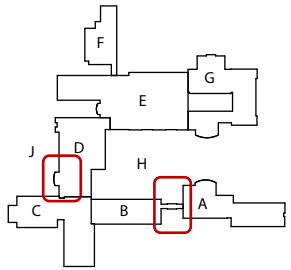

EXISTING CONDITIONS

- a. Stress cracks observed at B110 corridor and D104 western entry wall.



RECOMMENDATIONS

- a. Patch and repair. In case of recurrence, engage Engineer to perform structural evaluation.

Cape Elizabeth Schools Needs Assessment

Finishes: Wear and Tear

RELATED SCOPES OF WORK

- EM-ALL-A-3000
- EM-ALL-A-3002

E-D-A-1008				
Priority		Cost		
		\$\$		
Coordination by Discipline				
<input checked="" type="checkbox"/>	<input type="checkbox"/>	<input type="checkbox"/>	<input type="checkbox"/>	<input type="checkbox"/>
A	M	E	P	FP
<input type="checkbox"/>	<input type="checkbox"/>	<input type="checkbox"/>	<input type="checkbox"/>	<input type="checkbox"/>
S	LS	SC	BE	C

EXISTING CONDITIONS

- a. Window apron missing (D100)
- b. Wallpaper damaged (D107)

RECOMMENDATIONS

- a. Replace missing apron
- b. Repair wallpaper



Water Damage at Window Frame

RELATED SCOPES OF WORK
M-ALL-A-2002

E-D104-A-1009				
Priority		Cost		
		\$		
Coordination by Discipline				
<input type="checkbox"/>	<input type="checkbox"/>	<input type="checkbox"/>	<input type="checkbox"/>	<input type="checkbox"/>
A	M	E	P	FP
<input type="checkbox"/>	<input type="checkbox"/>	<input type="checkbox"/>	<input checked="" type="checkbox"/>	<input type="checkbox"/>
S	LS	SC	BE	C

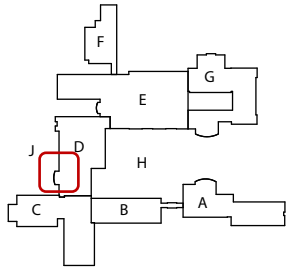

EXISTING CONDITIONS

- a. Signs of moisture issues at window frames. Gypsum board jamb return shows moisture damage at intersection with aluminum frame indicating possible failure of weather stripping.
- b. Due to the age of the window system, it is assumed the aluminum window frame is not thermally broken. Interior condensation may have contributed to interior condensation and moisture damage to gypsum wall board at jamb.

RECOMMENDATIONS

- a. Perform investigation to determine cause of moisture damage. If exterior masonry veneer is repaired take the opportunity to re flash the window perimeters.
- b. If window replacement is considered as part of a larger school wide effort (see Work Item M-ALL-A-2002), replace with a higher performance, thermally broken window system at each side of the entry doors.



Window adjacent to entry doors at Pond Cove Entry D104

Fire Rating at Boiler Room

RELATED SCOPES OF WORK

none

E-E121-LS-1010				
Priority	Cost			
	\$			
Coordination by Discipline				
<input type="checkbox"/>	<input checked="" type="checkbox"/>	<input type="checkbox"/>	<input type="checkbox"/>	<input type="checkbox"/>
A	M	E	P	FP
<input type="checkbox"/>	<input checked="" type="checkbox"/>	<input type="checkbox"/>	<input type="checkbox"/>	<input type="checkbox"/>
S	LS	SC	BE	C

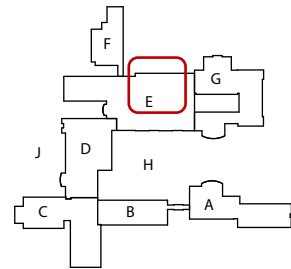

EXISTING CONDITIONS

Locker room is not separated from Boiler Room with a rated assembly. Studs are visible through the glass from the Locker Room side; glass is visible from the boiler room as evidence that wall does not extend to deck behind steel beam. Adjacent pipe mains require firestop.



RECOMMENDATIONS

Remove window and infill with rated wall assembly that continues to deck.

Repair Leaking Sprinkler System Riser

Existing Wet Pipe Sprinkler System Riser is Corroded and Leaking

RELATED SCOPES OF WORK

Not Applicable

E-C102-FP-1011				
Priority	Cost			
	\$\$			
Coordination by Discipline				
<input type="checkbox"/>	<input type="checkbox"/>	<input type="checkbox"/>	<input type="checkbox"/>	<input checked="" type="checkbox"/>
A	M	E	P	FP
<input type="checkbox"/>	<input checked="" type="checkbox"/>	<input type="checkbox"/>	<input type="checkbox"/>	<input type="checkbox"/>
S	LS	SC	BE	C

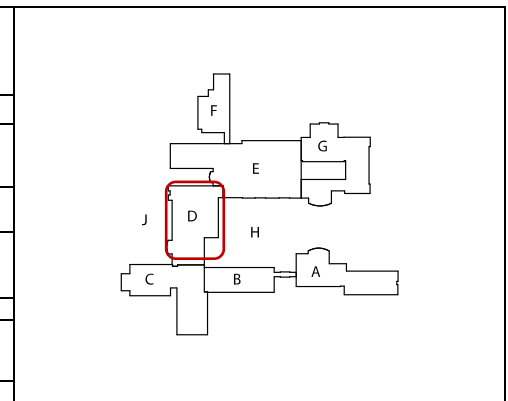

EXISTING CONDITIONS

The existing middle and elementary schools are protected throughout by automatic wet pipe sprinkler systems. The riser serving Area C is leaking and corroded.

Pricing has been obtained for this work; however, the original proposal has expired and is reported to be undergoing revision.

The existing incoming service and riser pipe supplying the sprinkler system appear to be in serviceable condition.



RECOMMENDATIONS

Repair and replace corroded sprinkler system riser components to stop leakage and further corrosion.

SCOPE OF WORK

Replace existing piping, hangers, stands, valves, and required trim to provide an NFPA 13 compliant automatic sprinkler system.

Stair C102 and C209 Life Safety Updates

RELATED SCOPES OF WORK

Not Applicable

E-C-LS-1012				
Priority	Cost			
	\$\$			
Coordination by Discipline				
<input checked="" type="checkbox"/>	<input type="checkbox"/>	<input type="checkbox"/>	<input type="checkbox"/>	<input type="checkbox"/>
A	M	E	P	FP
<input type="checkbox"/>	<input checked="" type="checkbox"/>	<input type="checkbox"/>	<input type="checkbox"/>	<input type="checkbox"/>
S	LS	SC	BE	C

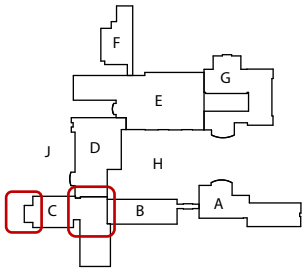

EXISTING CONDITIONS

Stair C102

- a. Staircase lacks handrailing on each side of the stair flight as required by IBC 1009.12
- b. Handrailing should be continuous without interruption, IBC 1012.4. Currently handrails are not graspable and do not wrap the central newel posts.
- c. Existing guard rails at landings are 36" high. IBC 1031.2 requires a height of 42".
- d. Current stair risers are 7 3/4". IBC 1009.4.2 lists 7" at maximum riser height.
- e. At the lowest level of exist discharge the area below the intermediate landing is enclosed with half a door and labeled "Mechanical Room". No penetrations, i.e. doors, are allowed in the exist enclosure other than exit access, IBC 1022.3.

Stair C209

- f. Handrail at staircase exceeds 1-1/2" diameter and is mounted at the incorrect height.

RECOMMENDATIONS

Stair C102

- a. Install handrailing at outer walls of stair enclosure. Provide handrail extension at stair landings.
- b. Add handrailing at interior railing with continuous gripping surface without interruption around end newel posts.
- c. Augment existing guards with additional railing at height of 42" inches AFF.
- d. To conform with the 7" riser height a full stair replacement would be necessary. Handrail corrections and additions should be the first priority.
- e. Use of the space below the stair landing should be discontinued. Door should be removed and replaced with a 1 hour fire partition.

Stair C209

- f. Replace handrail with handrail meeting required graspability. Augment existing guards with additional railing at height of 42" inches AFF.



Staircase C102



Unrated Ceiling at Janitor's Closet

RELATED SCOPES OF WORK
Not Applicable

E-C117-LS-1013				
Priority		Cost		
		\$		
Coordination by Discipline				
<input checked="" type="checkbox"/>	<input type="checkbox"/>	<input checked="" type="checkbox"/>	<input type="checkbox"/>	<input type="checkbox"/>
A	M	E	P	FP
<input type="checkbox"/>	<input checked="" type="checkbox"/>	<input type="checkbox"/>	<input type="checkbox"/>	<input type="checkbox"/>
S	LS	SC	BE	C

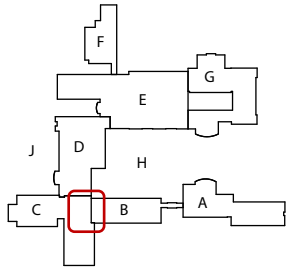

EXISTING CONDITIONS

- a. Unrated ceiling at janitor's closet below stairway in Lobby C120.
- b. Unrated door and frame into Janitor's Closet C117



Ceiling of Janitor's Closet C117

RECOMMENDATIONS

- a. Install UL listed GWB suspended ceiling. Fire seal all penetrations.
- b. Remove existing door and frame and replace with fire rated door, frame and hardware to achieve 1 hour fire rating.

Replace and Relocate Kindergarten Roof Hood

IH-1 shows significant rust.

RELATED SCOPES OF WORK

- E-ROOF-M-1014
- EM-ALL-A-3056
- E-C-M-1021
- E-ROOF-M-1026

E-ROOF-M-1015				
Priority	Cost			
	\$			
Coordination by Discipline				
<input checked="" type="checkbox"/>	<input checked="" type="checkbox"/>	<input type="checkbox"/>	<input type="checkbox"/>	<input type="checkbox"/>
A	M	E	P	FP
<input checked="" type="checkbox"/>	<input type="checkbox"/>	<input type="checkbox"/>	<input checked="" type="checkbox"/>	<input type="checkbox"/>
S	LS	SC	BE	C

EXISTING CONDITIONS

Intake hood IH-1 is located in the southeast corner of the kindergarten roof. The existing hood is a Carnes model GIGB01201220EY 05, serial number 830242.001, and was installed in October 2004. Due to the adjacent B-wing's additional height above the kindergarten wing, this corner appears to be a key location for leaf and snow drift piles to accumulate. IH-1 is also closer to EF-1, EF-2, and EF-4 than the required ten feet minimum. These exhaust fans are to be relocated under work item E-ROOF-M-1014.

RECOMMENDATIONS

Replace IH-1 in kind, with the exception that an aluminum top is recommended to help minimize rust. Relocate IH-1 such that it is a minimum of ten feet from all exhaust fans as well as ten feet from the roof edge. Coordinate relocation of IH-1 closely with relocation of EF-1, EF-2, and EF-4 on the same roof, which are to be relocated under work item E-ROOF-M-1014. These are the minimum separation distances as required by code.



SCOPE OF WORK

Replace intake hood IH-1 with an aluminum top intake hood, and relocate such that it is at least fifteen feet from the internal corners of the roof, ten feet from the roof edge, and ten feet from all exhaust fans. Coordinate with work item E-ROOF-M-1014. Provide extended ductwork in the ceiling below to accommodate new location. Provide testing and balancing to maintain existing airflows. Patch existing roof opening and provide support and flashing at new roof opening.

Relocate Kiln Closer to Art Room

Kiln is in janitor's closet
Remote from Art room

RELATED SCOPES OF WORK

Not Applicable

E-B106-M-1019	
Priority	Cost
	\$
Coordination by Discipline	
<input checked="" type="checkbox"/>	<input checked="" type="checkbox"/>
<input checked="" type="checkbox"/>	<input checked="" type="checkbox"/>
<input checked="" type="checkbox"/>	<input type="checkbox"/>
<input type="checkbox"/>	<input type="checkbox"/>
A	M
E	P
FP	
<input type="checkbox"/>	<input type="checkbox"/>
<input type="checkbox"/>	<input type="checkbox"/>
<input type="checkbox"/>	<input type="checkbox"/>
S	LS
SC	BE
C	

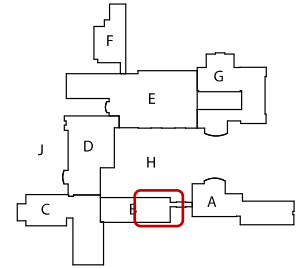

EXISTING CONDITIONS

Kiln is located in a janitor's closet, which also houses electrical power panels and transformer, as well as janitorial services and the ladder to a roof hatch. The room is inconveniently remote from Art Room A128, and is not a suitable space for use by teachers and students due to the other services in the room. The room also has minimal ventilation which was suitable only for the janitorial use, and does not appear to be sized for the kiln heat or the transformer.

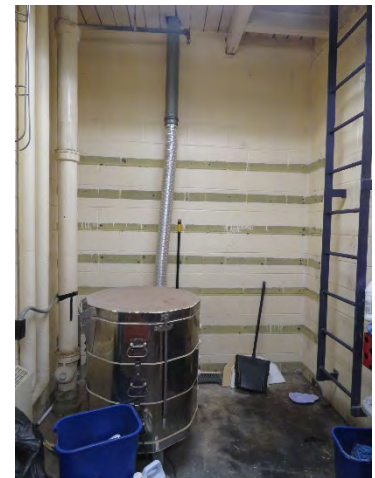

RECOMMENDATIONS

Provide a new dedicated kiln room, close to the Art Room.

SCOPE OF WORK

Provide architectural and engineering services to design the new room and associated ventilation and other needs. Construct the room, including demolition as necessary. Provide exhaust and makeup air for ventilation, lighting, and electrical power supplies as necessary. Relocate the kiln and its base exhaust unit, and provide ductwork, roof curb, and roof cap or hood. Provide roof penetration and flashing.

Provide Improved HVAC Control for Band Room

Reportedly insufficient

RELATED SCOPES OF WORK

EM-ALL-M-3037

E-A127-M-1020					
Priority	Cost				
	\$				
Coordination by Discipline					
<input checked="" type="checkbox"/>	<input checked="" type="checkbox"/>		<input checked="" type="checkbox"/>	<input type="checkbox"/>	<input type="checkbox"/>
A	M		E	P	FP
<input type="checkbox"/>	<input type="checkbox"/>		<input type="checkbox"/>	<input type="checkbox"/>	<input type="checkbox"/>
S	LS	SC	BE	C	

EXISTING CONDITIONS

The temperature control for the room is reportedly insufficient for the users.

RECOMMENDATIONS

Repair or replace controls. Replacing blank wall sensor with one having user adjustable setpoint may suffice – see work item EM-ALL-M-3037 to provide room sensors.

SCOPE OF WORK

Provide engineering services to determine control deficiencies and needs, in cooperation with the space users. Remove existing controls as necessary and provide new controls. Provide electrical power supplies as necessary.

Relocate Gooseneck on Kindergarten Roof

Too close to operable windows
 Corner is a snow drift zone

RELATED SCOPES OF WORK

EM-ALL-A-3056
 E-ROOF-M-1014

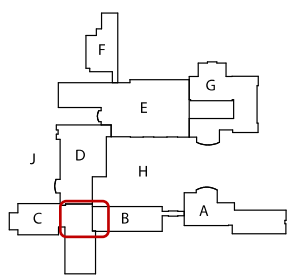
E-C-M-1021					
Priority	Cost				
	\$				
Coordination by Discipline					
<input checked="" type="checkbox"/>	<input checked="" type="checkbox"/>		<input type="checkbox"/>	<input type="checkbox"/>	<input type="checkbox"/>
A	M		E	P	FP
<input type="checkbox"/>	<input type="checkbox"/>	<input type="checkbox"/>	<input type="checkbox"/>	<input type="checkbox"/>	
S	LS	SC	BE	C	

EXISTING CONDITIONS

Unidentified gooseneck is too close to operable windows, and is close to exhaust fan.



RECOMMENDATIONS

Identify the gooseneck to determine its use as an exhaust or an intake. If it is exhaust, relocate gooseneck to provide more than the 10-foot minimum clearance from air intakes and operable windows required by Codes. For either use, relocate it out of the snow drift zone near the walls to prevent blockage by snow.

NEXT LEVEL

Provide a roof curb to properly support the ductwork at the penetration. Consider a manufactured roof hood instead of a duct gooseneck.

SCOPE OF WORK

Remove the gooseneck and its ductwork to a suitable location below the roof. Patch the roof opening to match all components of the existing adjacent roof assembly. Provide a roof penetration at the new location. Provide support for the gooseneck to prevent it moving within the penetration; consider providing a supporting curb with blocking to the roof deck. Install the gooseneck with extended ductwork, locating its inlet at a suitable height above the roof and anticipated snow level. Flash the penetration into the roofing membrane.

Cape Elizabeth Schools Needs Assessment

EF-7 Replace Roof Cap

Roof cap is rusting and is the incorrect type for the application.

RELATED SCOPES OF WORK

EM-ALL-A-3056

E-ROOF-M-1022		
Priority	Cost	
	\$	
Coordination by Discipline		
<input checked="" type="checkbox"/>	<input checked="" type="checkbox"/> <input type="checkbox"/> <input type="checkbox"/> <input type="checkbox"/>	
A	M E P FP	
<input type="checkbox"/>	<input type="checkbox"/> <input type="checkbox"/> <input type="checkbox"/> <input type="checkbox"/>	
S	LS SC BE C	

EXISTING CONDITIONS

Exhaust fan EF-7 (duplicate numbering) serves toilet room A110 adjacent to Corridor A100, and terminates with a roof jack. This unit shows significant aging. The existing roof jack is one typically intended for a sloped roof yet is located on a flat roof.

RECOMMENDATIONS

Replace Elementary School EF-7 roof jack with an aluminum air relief roof hood designed for installation on a flat roof.



SCOPE OF WORK

Replace roof jack for EF-7 with an aluminum air relief roof ventilator. Provide flashing around air relief.

Replace HRU-2 in A-Wing

Unit is old with corroded coil pipes
Consider energy recovery

RELATED SCOPES OF WORK

EM-ALL-P-3046

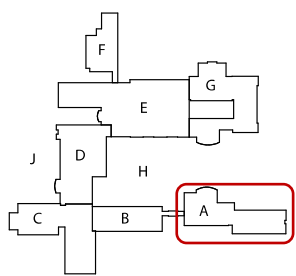
E-ROOF-M-1023				
Priority	Cost			
	\$\$			
Coordination by Discipline				
<input checked="" type="checkbox"/>	<input checked="" type="checkbox"/>	<input checked="" type="checkbox"/>	<input type="checkbox"/>	<input type="checkbox"/>
A	M	E	P	FP
<input checked="" type="checkbox"/>	<input type="checkbox"/>	<input type="checkbox"/>	<input type="checkbox"/>	<input type="checkbox"/>
S	LS	SC	BE	C

EXISTING CONDITIONS

Coil pipes inside unit are corroding. Unit is old and beyond its expected useful life. Intake hood has retrofitted extension. Base and other components are rusted. Control dampers are faulty.

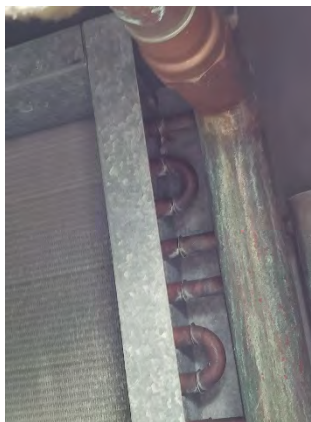

RECOMMENDATIONS

Replace unit to provide components meeting current code requirements include energy recovery, adjustable dampers, an efficient coil, and digital controls.

SCOPE OF WORK

Remove existing unit. Install new unit with energy recovery, and connect to ductwork, piping, and controls. Expand roof opening, structural steel, and curb as required. Provide electrical power supply sized for new unit.

Provide New Bubblers on Classroom Sinks

Bubblers are old and failing and were installed before lead-free laws

RELATED SCOPES OF WORK

- EM-ALL-A-3000
- EM-ALL-A-3007

E-ALL-P-1024	
Priority	Cost
	\$\$
Coordination by Discipline	
<input checked="" type="checkbox"/>	<input type="checkbox"/>
<input type="checkbox"/>	<input checked="" type="checkbox"/>
<input type="checkbox"/>	<input type="checkbox"/>
A	M E P FP
<input type="checkbox"/>	<input type="checkbox"/>
<input type="checkbox"/>	<input type="checkbox"/>
S	LS SC BE C

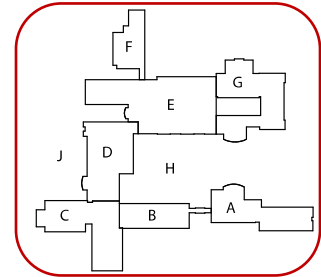

EXISTING CONDITIONS

Sink bubblers are in varying conditions of repair, corrosion, and looseness in connection to the sinks. They are generally aged and were built before the recent Federal law requiring lead-free construction in plumbing water components.



RECOMMENDATIONS

Replace sink bubblers and associated piping to provide lead-free components and replace corroded piping.

SCOPE OF WORK

Remove sink bubblers and branch piping. Provide new lead-free bubblers and piping. Provide hands-free electronic sensor-controlled bubblers if available.

Cape Elizabeth Schools Needs Assessment

Repair Grout CMU Crack

Crack through CMU blocks in gymnasium

E-E-S-1025					
Priority	Cost				
	\$				
Coordination by Discipline					
<input type="checkbox"/>	<input type="checkbox"/>		<input type="checkbox"/>	<input type="checkbox"/>	<input type="checkbox"/>
A	M		E	P	FP
<input checked="" type="checkbox"/>	<input type="checkbox"/>	<input type="checkbox"/>	<input type="checkbox"/>	<input type="checkbox"/>	
S	LS	SC	BE	C	

RELATED SCOPES OF WORK

Not Applicable

EXISTING CONDITIONS

The southeast corner of the gym has settled and there is a crack through the CMU blocks as shown in the photo below. The metal door on the south wall became jammed as a result and has been by the maintenance staff to allow it to open and close easily. It is unclear from this inspection if this area of the school is still experiencing settlement or if the structure shifted after initial construction and has since stopped settling.

RECOMMENDATIONS

CCE recommends adding epoxy mortar to this crack which will serve to repair it and allow it to be monitored to determine if this corner of the gym is still continuing to settle. If the repair grout cracks again in the future, further investigation and action will be required which could include, jacking up this portion of the structure and repairing the foundation. The door frame should also be measured to determine how far out of square it is. Additional repairs, such as increasing the size of the rough opening, may be required to permit installation of a non-modified door.

Scope of Work

The scope of work includes adding grout to repair the crack through the CMU blocks in this corner of the gym. Further analysis will be required if additional repairs are needed.

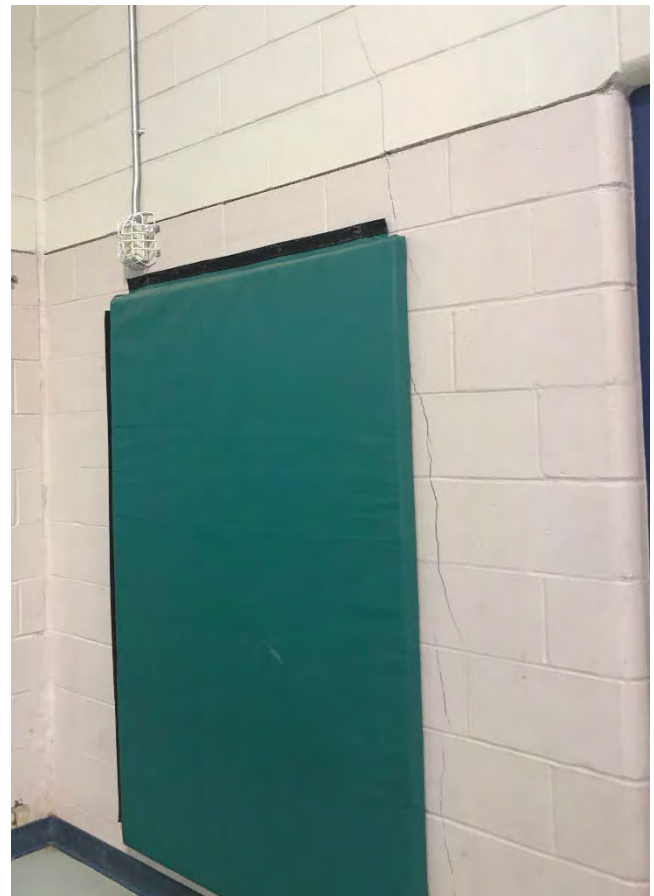

Replace Kindergarten Wing Intake Hood

Westernmost large intake hood on kindergarten roof is rusting.

RELATED SCOPES OF WORK

- EM-ALL-A-3056
- E-ROOF-M-1014
- E-ROOF-M-1015
- E-C-M-1021

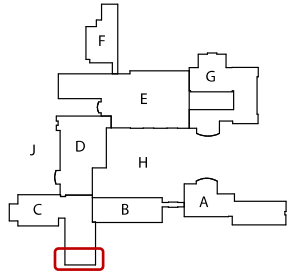
E-ROOF-M-1026				
Priority	Cost			
	\$			
Coordination by Discipline				
<input checked="" type="checkbox"/>	<input checked="" type="checkbox"/>		<input type="checkbox"/>	<input type="checkbox"/>
A	M	E	P	FP
<input type="checkbox"/>	<input type="checkbox"/>	<input type="checkbox"/>	<input type="checkbox"/>	<input type="checkbox"/>
S	LS	SC	BE	C

EXISTING CONDITIONS

The westernmost large intake hood on the kindergarten roof, labeled IH-1 (duplicate numbering) is rusted. The existing hood is a Carnes model GIGB02404820EY 05, serial number 830242 002, installed in October 2004.



RECOMMENDATIONS

Replace IH-1 in kind, with the exception of providing an aluminum construction rather than the existing galvanized construction, to minimize rust.

SCOPE OF WORK

Remove intake hood IH-1 (duplicate numbering). Provide an aluminum intake hood of the same size and style, and fasten to the existing curb at each factory mounting hole. Fasten and seal to ductwork as required.

Kitchen Cooler Upgrades

RELATED SCOPES OF WORK
M-D131-P-2045

M-D129-A-2000				
Priority	Cost			
	\$\$			
Coordination by Discipline				
<input checked="" type="checkbox"/>	<input checked="" type="checkbox"/>	<input checked="" type="checkbox"/>	<input checked="" type="checkbox"/>	<input type="checkbox"/>
A	M	E	P	FP
<input checked="" type="checkbox"/>	<input type="checkbox"/>	<input type="checkbox"/>	<input type="checkbox"/>	<input type="checkbox"/>
S	LS	SC	BE	C

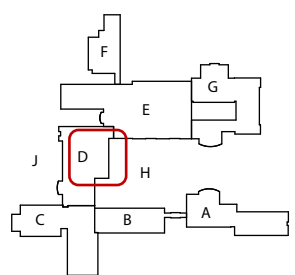

EXISTING CONDITIONS

The kitchen walk-in cooler is showing multiple signs of deterioration and possible failure.

- a. Rust is evident on much of the floor.
- b. The floor has substantial give to it. Per conversations with the manufacturer, Thermo-Kool, there may be a structural failure of the floor.
- c. Per conversations with the manufacturer, the flooring is no longer allowed by the National Sanitary Foundation (NSF). Acceptable flooring includes smooth aluminum, stainless steel, or vinyl.

RECOMMENDATIONS

Installing a vinyl surface on the existing steel panels would be the most economical solution, but given the possible structural failure of the floor panel, a more thorough investigation is recommended.

The existing floor panels should be removed to determine the source of the structural issue, so it can be remedied. New NSF-compliant floor panels should be installed. If the concrete slab is found to be deficient, further investigation and design will be required.



Kitchen cooler floor

Elevator Lobby G117

M-G117-A-2001	
Priority	Cost
	\$
Coordination by Discipline	
<input checked="" type="checkbox"/>	<input type="checkbox"/>
<input type="checkbox"/>	<input type="checkbox"/>
<input type="checkbox"/>	<input type="checkbox"/>
<input type="checkbox"/>	<input type="checkbox"/>
<input type="checkbox"/>	<input type="checkbox"/>
A	M E P FP
<input type="checkbox"/>	<input type="checkbox"/>
<input type="checkbox"/>	<input type="checkbox"/>
S	LS SC BE C

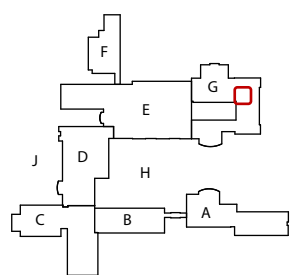

RELATED SCOPES OF WORK

Not Applicable

EXISTING CONDITIONS

- Student lockers prevent clear access to elevator call buttons which does not meet ADA requirements.

RECOMMENDATIONS

- Remove lockers to provide clear area of 48 inches in front of elevator call buttons.



SCOPE OF WORK

Remove lockers to provide clear area of 48 inches in front of elevator call buttons.

Courtyard Use and Egress

RELATED SCOPES OF WORK

Not Applicable

M-G-A-2003				
Priority	Cost			
	\$\$\$			
Coordination by Discipline				
<input checked="" type="checkbox"/>	<input type="checkbox"/>	<input checked="" type="checkbox"/>	<input type="checkbox"/>	<input type="checkbox"/>
A	M	E	P	FP
<input type="checkbox"/>	<input checked="" type="checkbox"/>	<input type="checkbox"/>	<input checked="" type="checkbox"/>	<input checked="" type="checkbox"/>
S	LS	SC	BE	C

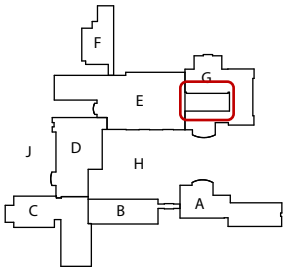

EXISTING CONDITIONS

The existing internal courtyard is unable to be utilized for the following reasons:

- The courtyard only has one means of egress, where life safety code requires two means of egress diagonally separated with egress hardware and exit signs.
- The courtyard is entirely planted, requiring extensive maintenance and without any defined areas for outdoor learning.

RECOMMENDATIONS

- Install an exit door into one of the existing window openings at the corridor on the east side of the courtyard.
- Equip the new exit door and the existing door with required egress hardware and install exit signs.
- Create designated container garden areas.
- Pave courtyard with concrete pavers.

NEXT LEVEL

- Create designated outdoor learning areas, including spaces with seating, white boards, lab areas, nature studies, etc.
- Replace wood furniture with furniture that requires little maintenance.

SCOPE OF WORK

- Install an exit door into one of the existing window openings at the corridor on the east side of the courtyard.
- Equip the new exit door and the existing door with required egress hardware and install exit signs.
- Create designated container garden areas.
- Pave remaining courtyard with concrete pavers.



View of courtyard from above

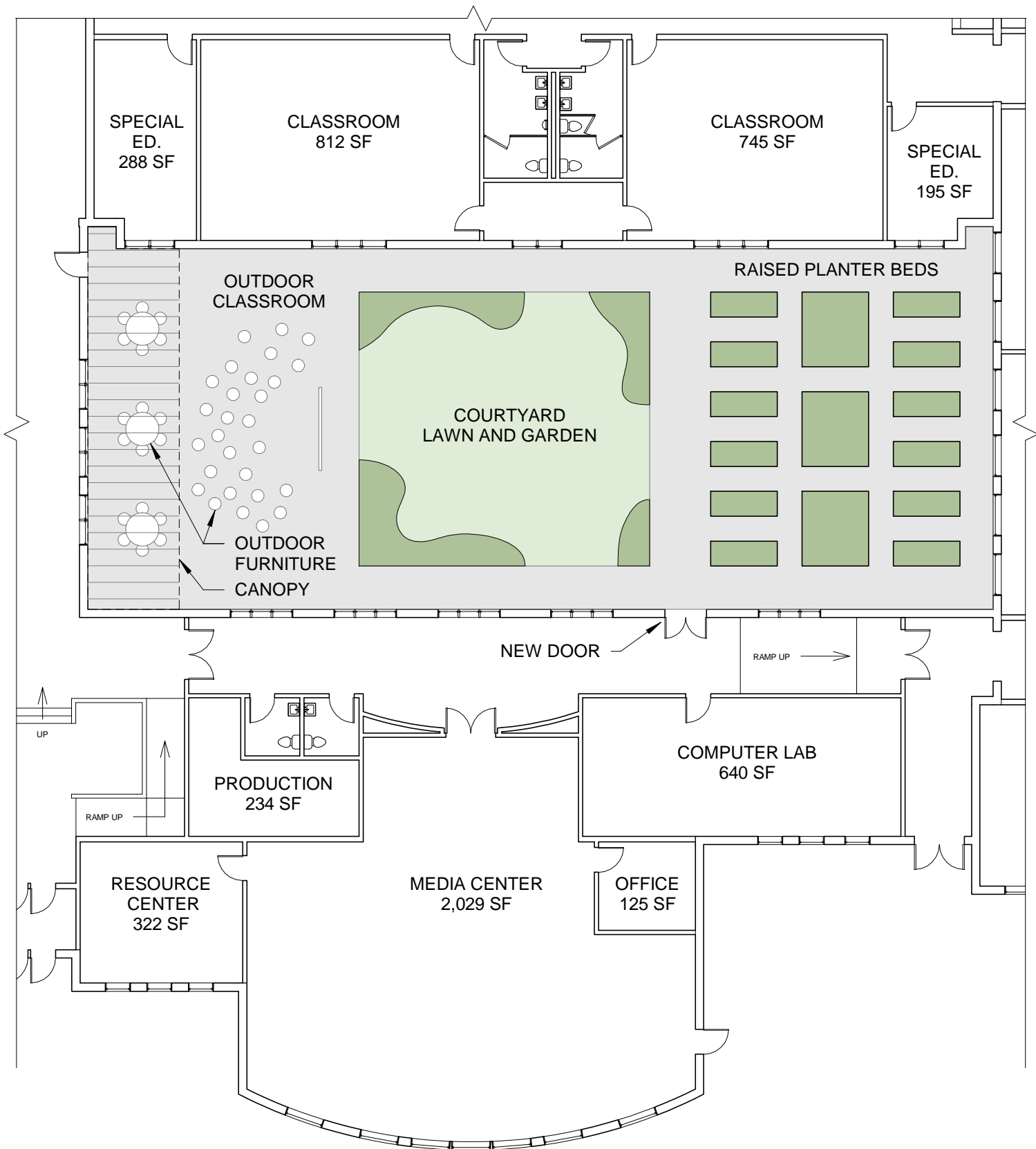

Music Department Improvements

RELATED SCOPES OF WORK

EM-D-A-3004
M-F113-M-2033

M-F113-A-2004				
Priority	Cost			
	\$			
Coordination by Discipline				
<input checked="" type="checkbox"/>	<input checked="" type="checkbox"/>	<input checked="" type="checkbox"/>	<input type="checkbox"/>	<input type="checkbox"/>
A	M	E	P	FP
<input type="checkbox"/>	<input checked="" type="checkbox"/>	<input type="checkbox"/>	<input type="checkbox"/>	<input type="checkbox"/>
S	LS	SC	BE	C

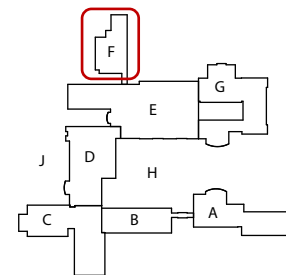

EXISTING CONDITIONS

The existing band room lacks proper acoustics, is undersized for a band with 350 members, has insufficient and poorly located instrument storage, and has egress compliance issues when the percussion instruments are being utilized.

Additionally, the fan coil unit regulating heat for the band room is so loud it's unable to be used during instruction and the band room is physically located far from the auditorium.

RECOMMENDATIONS

At a minimum, the exit sign at the exterior band room doors must be re-installed and access to this exit must be maintained at all times. Removal of the exit sign is a life safety code violation.

As an interim solution, acoustic wall treatment and a new mechanical system could improve the thermal comfort and acoustics of the space.

NEXT LEVEL

Some improvements can be made to the acoustics and mechanical noise issues in the current location, but the size of the room and the necessity for better storage are issues which require additional space. An addition could be constructed to better house the music department and, if funding aligns, could collocate with the auditorium improvements (see Work Item EM-D-A-3004).

SCOPE OF WORK

- Re-install band room exit sign.

If band room stays at current location:

- Install acoustic wall treatment in consultation with acoustical consultant.
- Install new mechanical system (see Mechanical work item M-F113-M-2033).

If auditorium renovations are pursued (see Work Item EM-D-A-3004):

- Consider relocating band room, chorus room, practice rooms for groups of 4, and instrument storage closer to the auditorium.
- Provide engineering services to design HVAC and sprinkler fire protection systems. Provide quiet HVAC systems (air conditioning recommended for some spaces) with air-to-air energy recovery and occupancy-based control (such as CO2 monitoring) for the ventilation air.

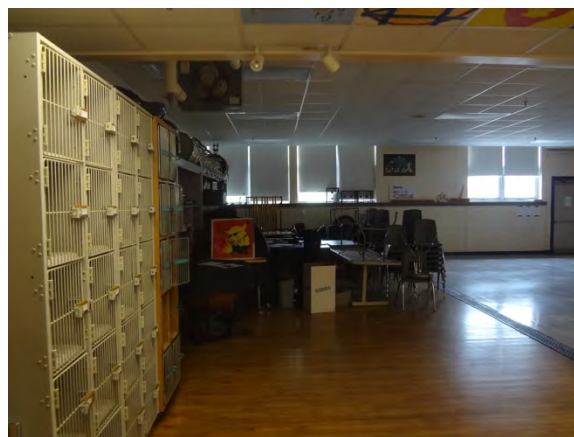

Band room storage (left side) is inadequate.

1934 Building – Basement Use

RELATED SCOPES OF WORK
M-C118-M-2028

M-G-A-2005				
Priority	Cost			
	\$\$			
Coordination by Discipline				
<input checked="" type="checkbox"/>	<input checked="" type="checkbox"/>	<input checked="" type="checkbox"/>	<input type="checkbox"/>	<input checked="" type="checkbox"/>
A	M	E	P	FP
<input type="checkbox"/>	<input checked="" type="checkbox"/>	<input type="checkbox"/>	<input type="checkbox"/>	<input type="checkbox"/>
S	LS	SC	BE	C

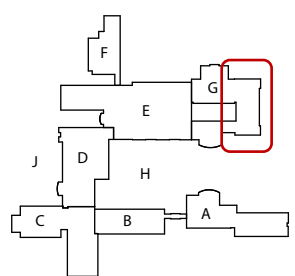

EXISTING CONDITIONS

The existing lower level of the original 1934 building is underutilized. It is lightly occupied with janitorial storage, district files, and miscellaneous housekeeping items. The space has two exits (one at grade), and can be utilized for additional educational space with minimal life safety improvements.

RECOMMENDATIONS

The design team recommends utilizing a portion of the space for student-use, whether additional classroom space or as an experiential learning space that requires additional room.

In order to occupy the space, a defined egress corridor with an approved UL assembly must be constructed.

Depending on the use, some mechanical (ventilation, possibly exhaust) and electrical (lighting) might be required.



Area to left of columns must be a defined egress corridor with a UL partition.

SCOPE OF WORK

- Construct UL-rated corridor to separate egress from main space.
- Make any mechanical and electrical renovations necessary to support intended use.

Programming Improvements and Expansion

RELATED SCOPES OF WORK

Not Applicable

M-NEW-A-2006				
Priority	Cost			
	TBD			
Coordination by Discipline				
<input checked="" type="checkbox"/>	<input checked="" type="checkbox"/>	<input checked="" type="checkbox"/>	<input checked="" type="checkbox"/>	<input checked="" type="checkbox"/>
A	M	E	P	FP
<input checked="" type="checkbox"/>	<input checked="" type="checkbox"/>	<input checked="" type="checkbox"/>	<input checked="" type="checkbox"/>	<input checked="" type="checkbox"/>
S	LS	SC	BE	C

EXISTING CONDITIONS

Flexible Breakout Space:

In teacher stakeholder meetings the need for flexible breakout spaces was identified. These spaces of approximately 100 square feet could serve as small private meeting spaces of up to 8 people. They could support the classroom by providing one-on-one space for a teacher and student tutoring sessions. If students are ahead or behind the teaching pace of a classroom, the breakout space provides separation. As a multi-purpose flexible space, it could meet many different needs such as a private parent-teacher conference in a small setting.

World Language Classrooms:

Two additional classroom spaces are needed to better support world language instruction.

RECOMMENDATIONS

Ideally each pair of classrooms would share access to a single breakout space. In future renovations and shifting programs, breakout spaces should be created if space becomes available.

SCOPE OF WORK

Currently the Pond Cove Elementary school and CE Middle School are comprised of approximately 66 classrooms. If possible, a single classroom in each wing could be converted to several break out spaces.

Assuming there are no excess classrooms, meeting this needs request requires additional space and pushes against space constraints and other needs of the school. As such, it's unlikely significant improvements can be made without dislocating another use. If an expansion is pursued as part of another Work Item, the A/E team could evaluate whether the expansion, or the evacuated space, is appropriate for this program.

Similarly, if expansion is pursued as part of another Work Item, the A/E team could evaluate whether the expansion, or the evacuated space, is appropriate for additional world language classrooms.

Notes on Costing: Given that the scope of this work may vary greatly, please see costing sheet and associated back-up for relevant unit pricing.

Counseling Space Improvements

RELATED SCOPES OF WORK
EM-NEW-SC-3051

M-E-A-2007				
Priority	Cost			
	TBD			
Coordination by Discipline				
<input checked="" type="checkbox"/>	<input checked="" type="checkbox"/>	<input checked="" type="checkbox"/>	<input checked="" type="checkbox"/>	<input checked="" type="checkbox"/>
A	M	E	P	FP
<input checked="" type="checkbox"/>	<input checked="" type="checkbox"/>	<input checked="" type="checkbox"/>	<input checked="" type="checkbox"/>	<input checked="" type="checkbox"/>
S	LS	SC	BE	C

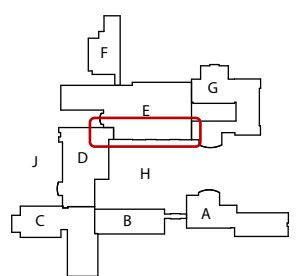

EXISTING CONDITIONS

The existing counseling space for the middle school is too small and offices aren't collocated, resulting in inefficiencies and communication gaps.

RECOMMENDATIONS

Provide a counseling suite with:

- a. Welcoming entry / lobby space for a few students to wait.
- b. Meeting space for 6-8.
- c. Offices.
- d. Supervised student meeting space.

SCOPE OF WORK

Meeting the requested needs of this user group requires additional space and pushes against space constraints and other needs of the school. As such, it's unlikely significant improvements can be made without dislocating another use.

If another work item is pursued that relocates some existing functions, such as EM-NEW-SC-3051 (New Secure Entrance and Support Spaces), this may allow some of the spaces currently serving office functions to be re-purposed for an expanded counseling space. Alternatively, the expansion may be able to support this program use directly.

If an expansion is pursued as part of another Work Item, the A/E team could evaluate whether the expansion, or the evacuated space, is appropriate an expanded counseling suite.

Notes on Costing: Given that the scope of this work may vary greatly, please see costing sheet and associated back-up for relevant unit pricing.

Maker Space Improvements

RELATED SCOPES OF WORK

Not Applicable

M-E137-A-2008				
Priority	Cost			
	TBD			
Coordination by Discipline				
<input checked="" type="checkbox"/>	<input checked="" type="checkbox"/>	<input checked="" type="checkbox"/>	<input checked="" type="checkbox"/>	<input checked="" type="checkbox"/>
A	M	E	P	FP
<input checked="" type="checkbox"/>	<input checked="" type="checkbox"/>	<input checked="" type="checkbox"/>	<input checked="" type="checkbox"/>	<input type="checkbox"/>
S	LS	SC	BE	C

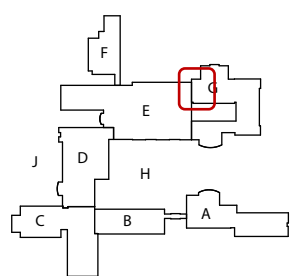

EXISTING CONDITIONS

The maker space is in the process of being relocated from G110 to E137. While this allows for some additional flexibility (with G110 remaining as storage), it is still small (240sf) and will likely not accommodate the number of students, projects, and equipment necessary.

RECOMMENDATIONS

Experiential learning, such as a maker space, requires significant space and pushes against space constraints and other needs of the school. As such, it's unlikely significant improvements can be made without dislocating another use. Should an addition be pursued for another work item, it may be possible to also include a new maker space assuming there is available funding.

An ideal maker space would contain the following features –

- Flexible, versatile space that is dividable if needed.
- Integrated power, data, ventilation, and exhaust to support digital and physical projects.
- Acoustic control.
- (2) mid-size spaces, able to accommodate 8-12 students, and their projects, each.
- (4) small rooms with green walls for video work.
- Preferably, centrally located.

SCOPE OF WORK

If an addition is pursued for another work item, the A/E team could evaluate whether a maker space is appropriate to include as part of that work.

Notes on Costing: Given that the scope of this work may vary greatly, please see costing sheet and associated back-up for relevant unit pricing.

Failing Precast Window Sills

RELATED SCOPES OF WORK

Not Applicable

M-G-BE-2010					
Priority	Cost				
	\$\$\$				
Coordination by Discipline					
<input checked="" type="checkbox"/>	<input type="checkbox"/>	<input type="checkbox"/>	<input type="checkbox"/>	<input type="checkbox"/>	<input type="checkbox"/>
A	M	E	P	FP	
<input checked="" type="checkbox"/>	<input type="checkbox"/>	<input type="checkbox"/>	<input checked="" type="checkbox"/>	<input type="checkbox"/>	
S	LS	SC	BE	C	

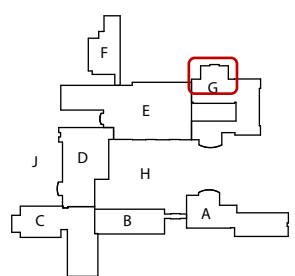

EXISTING CONDITIONS

The 1960 addition to the Middle School utilizes a window combination that consists of (2) double-hung windows with a fixed picture window between. The combinations are set in composite brick wall construction with precast concrete sills that are composed of (4) individual pieces. The team witnessed locations where the embedded anchors in the precast sills have lost their anchorage causing the sills to come loose, dislodge, and partially move into the wall cavity. At locations where the sills have not lost their anchorage, the mortar between the sill pieces is no longer present. This condition must be immediately remedied as it presents the following concerns:

- Water entry and damage to interior finishes.
- Freeze/thaw spall of brick and/or precast concrete.
- Potential for loose precast sills to fall out of opening.

Additionally, in many instances the large picture window has lost its glazing seal, resulting in reduced thermal performance, reduced visual clarity, and potential water intrusion.

RECOMMENDATIONS

Remove the existing window units at each location. Remove existing sill construction to level of flashing (1 brick course below). Replace flashing, damaged masonry, and membrane flashing to create water tight condition with weeps. Install new window units.



Dislodged precast window sills



Embedded anchor no longer attached to backup

SCOPE OF WORK

At 10 locations, remove existing windows and associated masonry and flashing at sill condition. Reconstruct sill condition and install new window units. As a temporary measure, re-set and anchor loose precast window sills. Install backer rod and sealant at the ends and joints between precast sill pieces. Re-point missing / damaged mortar joints as required.

1934 Building – General Exterior Repair

RELATED SCOPES OF WORK

Not Applicable

M-G-BE-2011	
Priority	Cost
	\$
Coordination by Discipline	
<input checked="" type="checkbox"/>	<input type="checkbox"/>
<input type="checkbox"/>	<input type="checkbox"/>
<input type="checkbox"/>	<input type="checkbox"/>
<input type="checkbox"/>	<input type="checkbox"/>
<input type="checkbox"/>	<input checked="" type="checkbox"/>
<input type="checkbox"/>	<input type="checkbox"/>
A	M
E	P
FP	
S	LS
SC	BE
C	

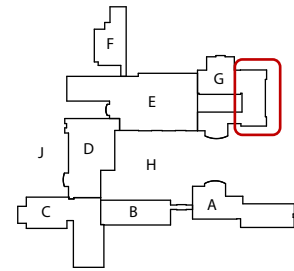

EXISTING CONDITIONS

Generally, the exterior condition of the 1934 building is in good shape. Composite wall construction, water shedding at the cornices, and a strong maintenance plan show that the building’s exterior is aging well.

Areas of concern include:

- a. Some deteriorated and rotting wood trim.
- b. Some cast stone sills have deteriorated due to weather exposure.

RECOMMENDATIONS

- a. Remove and replace damaged wood. Where possible, metal or fiberglass extrusions to match the historic profiles could be utilized to reduce future maintenance costs associated with wood in a coastal environment.
- b. Patch sills with high-strength concrete and apply a high-quality concrete stain on the surface.



Deteriorating cast stone sills



Spalling concrete at foundation and wood rot

Provide conduit support in mechanical room

RELATED SCOPES OF WORK

Not Applicable

M-ALL-E-2014	
Priority	Cost
	\$
Coordination by Discipline	
<input type="checkbox"/>	<input type="checkbox"/>
<input checked="" type="checkbox"/>	<input type="checkbox"/>
<input type="checkbox"/>	<input type="checkbox"/>
A	M
E	P
FP	
<input type="checkbox"/>	<input type="checkbox"/>
<input type="checkbox"/>	<input type="checkbox"/>
S	LS
SC	BE
C	

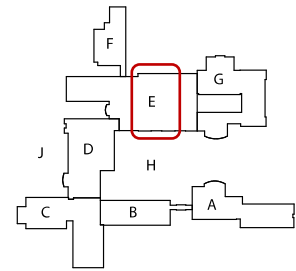

EXISTING CONDITIONS

The existing conduits in the mechanical room do not have independent supports required by the electrical code.



RECOMMENDATIONS

Provide code compliant support for conduits independent of mechanical piping.

SCOPE OF WORK

Removal straps attaching conduits to piping, provide code compliant support.

Automatic Fire Sprinkler Protection of Concealed Combustible Spaces

Combustible concealed spaces above ceilings are lacking sprinkler protection in some areas and is obstructed in others.

RELATED SCOPES OF WORK

Not Applicable

M-D117-FP-2015	
Priority	Cost
	\$\$
Coordination by Discipline	
<input checked="" type="checkbox"/>	<input type="checkbox"/>
<input type="checkbox"/>	<input type="checkbox"/>
<input type="checkbox"/>	<input checked="" type="checkbox"/>
A	M E P FP
<input type="checkbox"/>	<input checked="" type="checkbox"/>
<input type="checkbox"/>	<input type="checkbox"/>
S	LS SC BE C

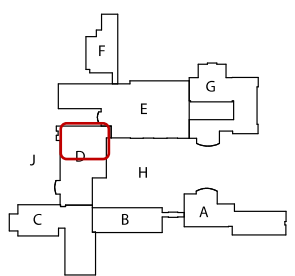

EXISTING CONDITIONS

The existing middle and elementary schools are protected throughout by automatic wet pipe sprinkler systems. Areas of coverage include combustible concealed spaces created by combustible construction materials above ACT ceilings.

The roof deck above the ceiling in this corridor is sloped and the ceiling space is divided by an HVAC duct. the currently installed sprinklers are installed at the low side of the roof deck slope and obstructed by the HVAC duct.



RECOMMENDATIONS

Install an additional line of sprinklers at the upper elevation of the roof pitch on the other side of the duct obstruction as required by NFPA 13.

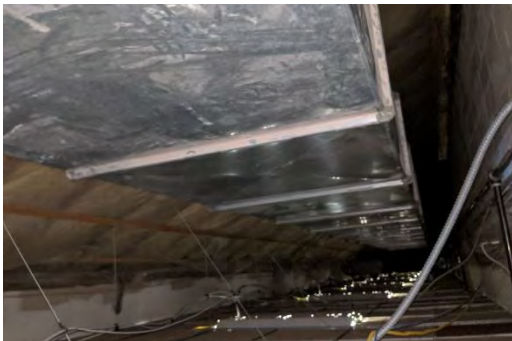

SCOPE OF WORK

Provide sprinklers, piping, hangers, valves, and required trim to provide an NFPA 13 compliant automatic sprinkler system protection throughout all combustible concealed spaces.

Relocate Kitchen Hood Manual Pull

Fire suppression system manual pull
Is too close to the hood

RELATED SCOPES OF WORK

EM-D131-M-3045

M-D131-FP-2016	
Priority	Cost
	\$
Coordination by Discipline	
<input checked="" type="checkbox"/>	<input checked="" type="checkbox"/> <input type="checkbox"/> <input type="checkbox"/> <input checked="" type="checkbox"/>
A	M E P FP
<input type="checkbox"/>	<input checked="" type="checkbox"/> <input type="checkbox"/> <input type="checkbox"/> <input type="checkbox"/>
S	LS SC BE C

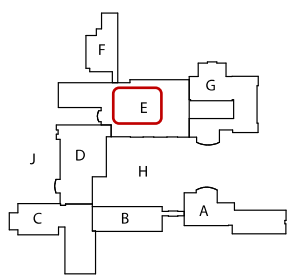

EXISTING CONDITIONS

Kitchen hood fire suppression system manual pull is located only a few feet from the hood, not at least 10 feet as required by the building Code.



RECOMMENDATIONS

Relocate the manual pull to at least 10 feet from the hood along a natural egress path, as required by the IBC (International Building Code) chapter 904.12.1.

SCOPE OF WORK

Remove and store the manual pull for reinstallation. Remove the pull cable from the manual pull to the fire suppression system release mechanism. Mount the manual pull in its new location, and provide extended surface-mounted conduit. Provide new pull cable of length required. Test the manual pull and obtain required approvals for hood operation.

Exit Width Diminished

M-G128-LS-2017	
Priority	Cost
	\$
Coordination by Discipline	
<input checked="" type="checkbox"/>	<input checked="" type="checkbox"/> <input type="checkbox"/> <input type="checkbox"/> <input type="checkbox"/>
A	M E P FP
<input type="checkbox"/>	<input checked="" type="checkbox"/> <input type="checkbox"/> <input type="checkbox"/> <input type="checkbox"/>
S	LS SC BE C

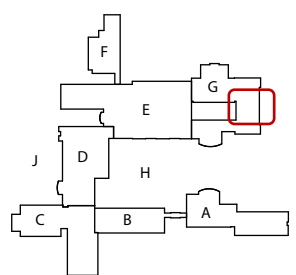

RELATED SCOPES OF WORK
EM-ALL-M-3043

EXISTING CONDITIONS

Exit width diminished in direction of travel
Handrailing tapers to avoid radiator and reduces exit width

RECOMMENDATIONS

While technically the railing is in violation of life safety code, exiting width is determined by width of paired doors at top and bottom of stairs. Proper configuration of railing would require the elimination of the existing radiator.



Corridor G128

Special Ed Room: ADA & Life Safety Upgrades

RELATED SCOPES OF WORK
M-G-P-2048

M-E109-LS-2019				
Priority	Cost			
	\$\$			
Coordination by Discipline				
<input checked="" type="checkbox"/>	<input checked="" type="checkbox"/>	<input checked="" type="checkbox"/>	<input checked="" type="checkbox"/>	<input type="checkbox"/>
A	M	E	P	FP
<input type="checkbox"/>	<input checked="" type="checkbox"/>	<input type="checkbox"/>	<input type="checkbox"/>	<input type="checkbox"/>
S	LS	SC	BE	C

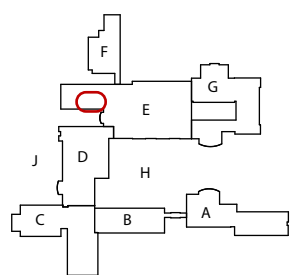

EXISTING CONDITIONS

- a. Existing range / oven lacks an exhaust hood and dedicated fire suppression system as required by NFPA 96.
- b. Kitchen sink is not ADA compliant.

RECOMMENDATIONS

- a. Install a self-contained, pre-engineered range hood with integral fire suppression and automatic cutoff. Basis of Design: Denlar Model D1036, front recirculating unit.
- b. Modify cabinetry for forward approach with 30" of width, sink rim height of 34" and knee clearance of 24" minimum.



Range lacks an NFPA compliant exhaust and suppression hood



Sink is not ADA compliant

SCOPE OF WORK

See recommendations above.

The D1000

Model: D1036-F
Spec & Submittal
Version 2.4

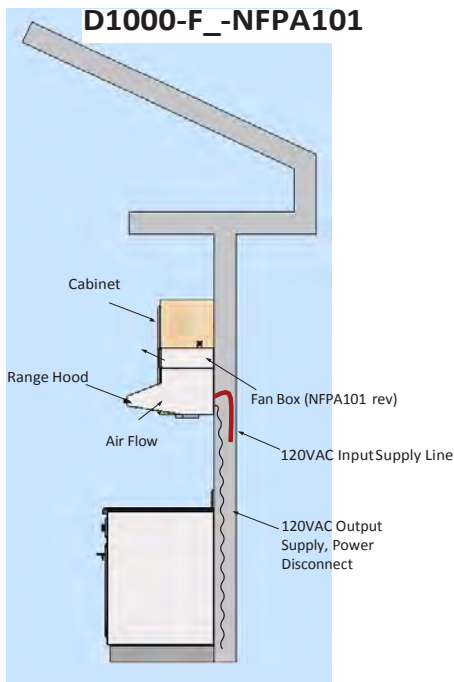
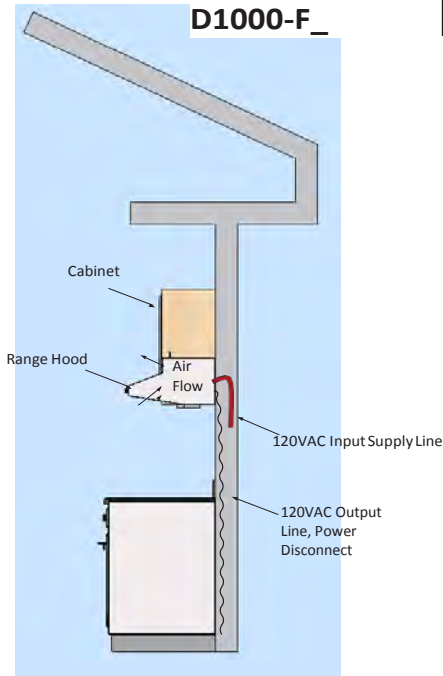

	Width	Fan Type	Venting	CFM (at hood)	DUCT LENGTH (max)
D1030---F_	30"	INTERNAL	FRONT (recirculating)	140 CFM	N/A
D1030---F_ (NFPA101)	30"	INTERNAL	FRONT (recirculating)	500 CFM	N/A
D1030---R_	30"	INTERNAL	REAREXPPELLING	250 CFM	N/A
D1030---R_ (NFPA101)	30"	INTERNAL	REAREXPPELLING	500 CFM	N/A
D1030---I_ ---DF	30"	In---Line Duct Fan	Vertical Duct	470 CFM	35 FEET
D1030---I_ ---DF (NFPA101)	30"	In---Line Duct Fan	Vertical Duct	510 CFM	35 FEET
D1030---I_ ---WF	30"	Exterior Wall Fan	Vertical Duct	150 CFM	20 FEET
D1030---I_ ---WF (NFPA101)	30"	Exterior Wall Fan	Vertical Duct	550 CFM	20 FEET
D1036---F_	36"	INTERNAL	FRONT (recirculating)	140 CFM	N/A
D1036---F_ (NFPA101)	36"	INTERNAL	FRONT (recirculating)	500 CFM	N/A
D1036---R_	36"	INTERNAL	REAREXPPELLING	250 CFM	N/A
D1036---R_ (NFPA101)	36"	INTERNAL	REAREXPPELLING	500 CFM	N/A
D1036---I_ ---DF	36"	In---Line Duct Fan	Vertical Duct	470 CFM	35 FEET
D1036---I_ ---DF (NFPA101)	36"	In---Line Duct Fan	Vertical Duct	510 CFM	35 FEET
D1036---I_ ---WF	36"	Exterior Wall Fan	Vertical Duct	150 CFM	20 FEET
D1036---I_ ---WF (NFPA101)	36"	Exterior Wall Fan	Vertical Duct	550 CFM	20 FEET

Volts = 115 :: Hz = 60 :: Amps = 5 :: Light Bulb = 60A15/TF :: Elec. Cutoff = 50A--208VAC Relay :: Gas Cutoff = 120VAC Solenoid

Typical Specifications:

Hood shall:

- be D1000 Series by DENLAR Fire Protection
- be wall mounted so that the bottom of the mounting bracket sits 30" to 36" above the range
- be of stainless steel construction (#18 & #20 GA, polished 304) with no sharp edges and brushed finish
- have factory installed fire suppression system
- have 212 or 280 degree fusible link (30" vs 36") which will activate the mechanical fire suppression system
- have Wet chemical extinguishing agent: Low PH Amerex 660 (pressurized potassium citrate / potassium acetate mix)
- have centrifugal fan with air delivery of 380 to 610 CFM, fan speed controller will be infinitely variable
- be ETL listed, tested to UL300A standards,
- fan motor shall be permanently lubricated and meet UL507
- include a power disconnect device for gas and electric appliances, activated at suppression system discharge
- automatically disconnect range element once a certain pre-set temperature is reached
- Unit shall have multiple alarm contacts pre-installed (local, remote and trouble alarms) and an audible buzzer
- Lighting shall be by 60w shatter-proof bulb

Standard Options*:

- MPK - Manual Pull Station Kit
- NSF - Upgrade to National Sanitation Foundation Compliance ADA - Handicap Accessible Control Box
- CLBX - THE CLOCKBOX (Password Protected, Range Element Timer)
- NFPA101 - Upgrade to NFPA Life Safety Code Compliance
- *Custom Powder coat Finishes Are Available



Cape Elizabeth Schools Needs Assessment

Replace EF-7 Roof Cap

Serves room E146 toilet. Roof cap is rusting and is the incorrect type for the application.

RELATED SCOPES OF WORK

Not Applicable

M-ROOF-M-2021				
Priority	Cost			
	\$			
Coordination by Discipline				
<input checked="" type="checkbox"/>	<input checked="" type="checkbox"/>		<input type="checkbox"/>	<input type="checkbox"/>
A	M	E	P	FP
<input type="checkbox"/>	<input type="checkbox"/>	<input type="checkbox"/>	<input type="checkbox"/>	<input type="checkbox"/>
S	LS	SC	BE	C

EXISTING CONDITIONS

Exhaust fan EF-7 serving room E146 toilet exhaust utilizes a roof jack which shows significant signs of aging. The existing roof jack is one typically intended for a sloped roof yet is located on a flat roof.

RECOMMENDATIONS

Replace roof jack with an aluminum air relief roof hood designed for installation on a flat roof.



SCOPE OF WORK

Replace roof jack for EF-7 with an aluminum air relief roof ventilator. Provide flashing around air relief.

Condensing Unit Repairs

Replace refrigerant piping insulation and attach units to roof

RELATED SCOPES OF WORK

M-G141-M-2042

M-ROOF-M-2022		
Priority	Cost	
	\$	
Coordination by Discipline		
<input checked="" type="checkbox"/> A <input checked="" type="checkbox"/> M <input checked="" type="checkbox"/> E <input type="checkbox"/> P <input type="checkbox"/> FP		
<input checked="" type="checkbox"/> S <input type="checkbox"/> LS <input type="checkbox"/> SC <input type="checkbox"/> BE <input type="checkbox"/> C		

EXISTING CONDITIONS

There are currently three condensing units located on the middle school roof above the library and computer lab, serving those spaces. There is also one condensing unit located on the middle school roof above the IT room, serving the IT room. These condensing units have aging refrigerant piping insulation, and the units are installed on 4x4 wooden sleepers which are not permanently affixed to the roof. This leaves the units susceptible to tipping over from high winds, as well as leaving the units low enough on the roof that they spend much of the winter submerged in snow.

RECOMMENDATIONS

Replace refrigerant piping insulation on all roof mounted condensing units, and provide PVC jacketing to protect and extend the useful life of the insulation. Provide stands to suspend condensing units at least 14 inches above the roof surface to maintain clearance above snow. Affix stand to both condensing unit and roof. Flash roof connection points to prevent water infiltration.



SCOPE OF WORK

Provide new insulation and PVC jacketing for refrigerant gas and suction lines to each of four rooftop condensing units. Provide structural and architectural support to permanently affix 14" tall stands for each condensing unit, including fasteners and flashing. Increasing the mounting height of the units may require additional refrigerant piping, which may be accomplished by brazing a new section onto the existing piping, or new line sets may be provided.

Replace AHU-5, 6, 7

Units are nearing end of useful life
Maintenance needs will soon rise

RELATED SCOPES OF WORK

EM-ALL-P-3046

M-E163-M-2023				
Priority	Cost			
	\$\$\$			
Coordination by Discipline				
<input checked="" type="checkbox"/>	<input checked="" type="checkbox"/>	<input checked="" type="checkbox"/>	<input type="checkbox"/>	<input type="checkbox"/>
A	M	E	P	FP
<input checked="" type="checkbox"/>	<input type="checkbox"/>	<input type="checkbox"/>	<input type="checkbox"/>	<input type="checkbox"/>
S	LS	SC	BE	C

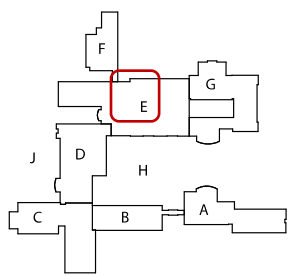

EXISTING CONDITIONS

AHU-5, 6, and 7 are nearing the end of their useful life. Outwardly visible signs include rust, leaking and corroded control valves and piping. Typically at this age inner components are wearing out as well. In general it appears that the exhaust and relief for these systems is located elsewhere rather than in this mechanical room.



RECOMMENDATIONS

Replace the air handling units in-kind with units of similar design. Replace controls and associated duct and piping components. Include upgrades to ventilation and controls to meet current Codes and standards.

NEXT LEVEL

Provide energy recovery systems to transfer heat energy from the outgoing exhaust airstreams to the incoming outside ventilation air streams entering each unit, as recommended by The Maine Department of Education Public School Standards and Guidelines for New School Construction & Major Renovation Projects.

SCOPE OF WORK

Base Level: Provide engineering services to verify performance requirements based on current use of the building, current mechanical codes, ventilation and energy efficiency standards, and other regulations and standards, in cooperation with the building users. Remove existing AHUs, controllers and controlled devices, and remove associated ductwork and piping to the extent required. Install new AHUs and controls, and reconnect to ductwork and piping. Provide electrical power supplies. Provide variable frequency drives (VFDs) for speed control as applicable.

Next Level: Provide energy or heat recovery systems. Energy recovery might include rerouting the exhaust and relief air streams to pass through the mechanical room at the associated air handler, and through an energy recovery exchanger within the air handler, with fans required to move the air through the exchanger and to outdoors. Heat recovery is less efficient but is an option if rerouting the air is not practical; this might consist of water coils in the existing ducts with pumped antifreeze circulation between them.

Re-insulate in Mech and Boiler Rooms

Older insulation is damaged or missing
Newer items are missing insulation

RELATED SCOPES OF WORK

- M-E163-M-2025
- M-E163-M-2026

M-E163-M-2024				
Priority		Cost		
		\$\$		
Coordination by Discipline				
<input type="checkbox"/>	<input checked="" type="checkbox"/>	<input type="checkbox"/>	<input checked="" type="checkbox"/>	<input type="checkbox"/>
A	M	E	P	FP
<input type="checkbox"/>	<input type="checkbox"/>	<input type="checkbox"/>	<input type="checkbox"/>	<input type="checkbox"/>
S	LS	SC	BE	C

EXISTING CONDITIONS

Ductwork: The insulation on many of the ducts, particularly at lower levels where maintenance and storage activities take place, is heavily damaged and crudely held together with electrician’s tape.

Piping: Insulation on heating and plumbing piping is generally water stained from current or past leaks, otherwise damaged, or missing. Missing insulation includes the new boiler room addition.

Equipment: Many items of equipment such as piping air separators, and large piping bodies such as valves, strainers, and pump suction diffusers, both hot for heating and plumbing and cold for plumbing water, are missing their insulation. This results in excessive heat in these rooms, heating fuel and solar water heating energy waste, and sweating and damage on the cold items. This condition applies to the former boiler room and its associated basement level space, and extensively in the new boiler room.



RECOMMENDATIONS

Replace the existing insulation, and provide insulation where missing. Include upgrades to thicknesses to meet current Codes and standards. Provide protection of the insulation where it is near the floor and subject to damage.

SCOPE OF WORK

Remove duct and piping insulation. On ductwork, provide rigid board type insulation where near the floor and subject to damage; flexible wrap type may be used at higher levels. On piping, provide rigid preformed fiberglass type insulation, with sealed outer vapor barrier; provide sturdy PVC jacket and fitting covers on piping near the floor. On equipment, including but not limited to valve bodies and strainers, provide rigid or semi-rigid high-density fiberglass insulation, with an outer vapor barrier finish; protect with PVC jacket and fitting covers. The Energy Code does not have an exception for piping valves and similar items; these must be insulated to the full thicknesses required by the Code. For frequently-serviced items such as strainer drain ports and test connections, use removable reusable insulation covers.

Repair-Replace Valves in Mech Room

Heating valves are old and leaking
 Plumbing valves are old, rusted

RELATED SCOPE OF WORK

M-E163-M-2024

M-E163-M-2025				
Priority	Cost			
	\$			
Coordination by Discipline				
<input type="checkbox"/>	<input checked="" type="checkbox"/>	<input type="checkbox"/>	<input checked="" type="checkbox"/>	<input type="checkbox"/>
A	M	E	P	FP
<input type="checkbox"/>	<input type="checkbox"/>	<input type="checkbox"/>	<input type="checkbox"/>	<input type="checkbox"/>
S	LS	SC	BE	C

EXISTING CONDITIONS

Heating control valves and other valves are aged and leaking. Plumbing cold water valves are old and externally rusted from condensation (sweating). Associated unions and flanges are also rusted or corroded.



RECOMMENDATIONS

Replace control valves and actuators. Replace plumbing valves and related fittings. Replace unions and flanges as appropriate. Insulate completely.

SCOPE OF WORK

Remove external insulation as necessary. Remove valves, actuators, and other items, and install replacements. Reconnect control wiring, reprogram controls as needed, and test and balance as necessary. Insulate components to meet Energy Code and to prevent sweating on cold surfaces. Provide protection of the insulation where it is near the floor and subject to damage.

Support for Pipes at Pumps P-3 and P-4

Pipes are not supported at pumps
Weight is compressing connectors

RELATED SCOPES OF WORK

M-E163-M-2024

M-E163-M-2026	
Priority	Cost
	\$
Coordination by Discipline	
<input type="checkbox"/>	<input checked="" type="checkbox"/>
A	M
<input type="checkbox"/>	<input type="checkbox"/>
S	LS
<input type="checkbox"/>	<input type="checkbox"/>
LS	SC
<input type="checkbox"/>	<input type="checkbox"/>
SC	BE
<input type="checkbox"/>	<input type="checkbox"/>
BE	C

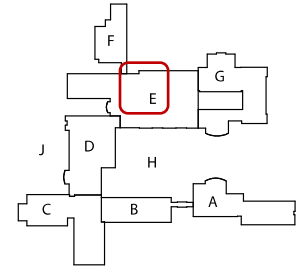

EXISTING CONDITIONS

The discharge pipes from the pumps are centrally supported by a floor-mounted structural steel stand, which supports the piping header several feet from the individual risers at the pumps. This support location allows the weight of this large piping to bear on the flexible connectors, as well as transferring some weight to the pumps. This compresses and visibly deforms the flexible connectors, which reduces their ability to isolate pump vibration from the piping as well as their ability to accommodate piping expansion due to heating. Bearing weight is also bad for the pumps.



RECOMMENDATIONS

Support the piping near the pump risers, taking weight off the pump connections. Replace the flexible connectors.

SCOPE OF WORK

Provide engineering services to design supports. Provide structural steel supports at each pump discharge riser. This support is anticipated to be floor mounted similar to the existing support stand; provide with height adjustment capability to enable proper installation of flexible connectors. Provide welded steel saddles on the pipes at each support riser. Remove the flexible connectors which have been compressed, and replace with new; install in a position of neutral compression to allow expansion and contraction. Adjust supports to allow the neutral connector compression. Repair and replace pipe insulation as necessary.

Repair Elevator Machine Room

Room has safety deficiencies

RELATED SCOPES OF WORK

M-G-A-2005

M-C118-M-2028	
Priority	Cost
	\$
Coordination by Discipline	
<input checked="" type="checkbox"/>	<input checked="" type="checkbox"/>
<input checked="" type="checkbox"/>	<input checked="" type="checkbox"/>
<input checked="" type="checkbox"/>	<input type="checkbox"/>
<input checked="" type="checkbox"/>	<input checked="" type="checkbox"/>
A	M
E	P
FP	
<input type="checkbox"/>	<input type="checkbox"/>
<input type="checkbox"/>	<input type="checkbox"/>
<input type="checkbox"/>	<input type="checkbox"/>
S	LS
SC	BE
C	

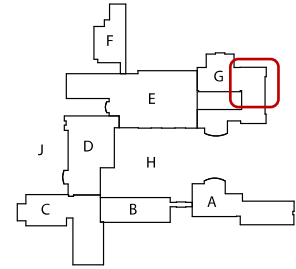

EXISTING CONDITIONS

The room has a low opening through the CMU wall to the adjacent room which has a fire damper that is roughly set in the opening rather than being fastened. A room cooling propeller fan is ducted through that same wall with a backdraft damper on the discharge, and the damper has been disrupted by a ceiling grid run across it in the adjacent room. Another fan is duct-mounted within the machine room. The walls have penetrations with unsealed openings.



RECOMMENDATIONS

Consult with the Elevator Inspector and other local Authorities Having Jurisdiction to verify requirements. Provide properly installed fire dampers. Provide proper fan installation and operation. Provide sealing and firestop of penetrations to meet code requirements and improve occupant safety.

SCOPE OF WORK

Provide properly installed fire dampers and fan. Provide sealing and firestop of penetrations. Consult with the Elevator Inspector and other local Authorities Having Jurisdiction to determine any additional requirements.

Provide Outdoor Air to Nurse's "Health" Office

Office and associated COT room have no ventilation supply air

RELATED SCOPES OF WORK

Not Applicable

M-E145-M-2029	
Priority	Cost
	\$
Coordination by Discipline	
<input checked="" type="checkbox"/>	<input checked="" type="checkbox"/>
<input checked="" type="checkbox"/>	<input checked="" type="checkbox"/>
<input checked="" type="checkbox"/>	<input type="checkbox"/>
<input type="checkbox"/>	<input type="checkbox"/>
<input type="checkbox"/>	<input type="checkbox"/>
<input type="checkbox"/>	<input type="checkbox"/>
<input type="checkbox"/>	<input type="checkbox"/>
S	LS
SC	BE
C	



EXISTING CONDITIONS

The rooms have no mechanically-supplied outdoor ventilation air, but tend to have a number of students with various illnesses, some contagious.

RECOMMENDATIONS

Provide mechanically-supplied ventilation air. Provide a hydronic duct heating coil to control supply air temperature. Provide return or exhaust to relieve the supply air.

NEXT LEVEL

Consider air conditioning for enhanced comfort.

SCOPE OF WORK

1. Base Level: Provide mechanically-supplied ventilation air from the nearest supply main, including room diffusers or registers, and ductwork. Provide a hydronic duct heating coil to control supply air temperature. Provide return or exhaust to relieve the supply air. Provide controls and wiring.
2. Next Level: Provide a ductless split system air conditioner. Provide interconnecting piping and wiring. Provide electric power supply. Provide outdoor unit supports, with roof flashed-in support rails if roof-mounted.

Improve Exhaust in Kiln Room

Room exhaust flow is restricted
Ceiling exhaust fan needs support

RELATED SCOPES OF WORK

Not Applicable

M-E164-M-2030				
Priority	Cost			
	\$			
Coordination by Discipline				
<input checked="" type="checkbox"/>	<input checked="" type="checkbox"/>	<input checked="" type="checkbox"/>	<input type="checkbox"/>	<input type="checkbox"/>
A	M	E	P	FP
<input type="checkbox"/>	<input type="checkbox"/>	<input type="checkbox"/>	<input type="checkbox"/>	<input type="checkbox"/>
S	LS	SC	BE	C

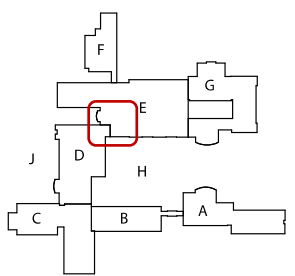

EXISTING CONDITIONS

The room has a ceiling-mounted exhaust fan with integral ceiling inlet grille. The fan is supported by the suspended ceiling grid, lacking supports to the structure. The duct includes a long run of flexible duct which is restrictive due to its rough interior and tendency to collapse and kink. The exterior wall discharge cap has a heavy backdraft flapper which further restricts airflow.

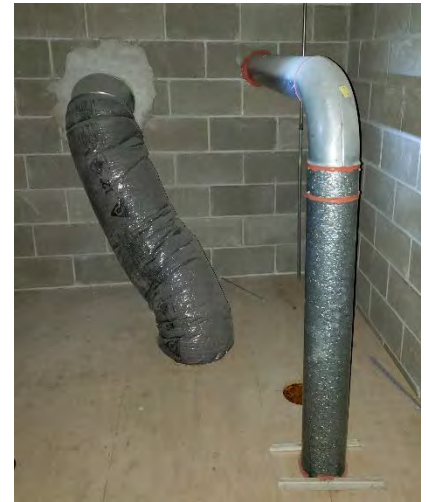

RECOMMENDATIONS

Support the fan from the structural mezzanine above, independent of the ceiling grid, to maintain proper support. Replace most of the flexible duct with rigid metal ducts and fittings per SMACNA standards. Replace the wall cap with one that opens easily to ensure that the fan is able to move the required amount of air.

SCOPE OF WORK

Provide fan supports and vibration isolators. Remove portions of flexible duct and provide rigid metal duct and fittings. Remove wall cap and provide a cap with a lightweight cap and flapper that opens easily.

Cape Elizabeth Schools Needs Assessment

Replace HRU-8 and 9

Units are nearing end of useful life
Maintenance needs will soon rise

RELATED SCOPES OF WORK

EM-ALL-P-3046

M-ROOF-M-2032	
Priority	Cost
	\$\$\$
Coordination by Discipline	
<input checked="" type="checkbox"/>	<input checked="" type="checkbox"/>
<input checked="" type="checkbox"/>	<input type="checkbox"/>
<input checked="" type="checkbox"/>	<input type="checkbox"/>
<input type="checkbox"/>	<input type="checkbox"/>
<input type="checkbox"/>	<input type="checkbox"/>
A	M E P FP
<input checked="" type="checkbox"/>	<input type="checkbox"/>
<input type="checkbox"/>	<input type="checkbox"/>
<input type="checkbox"/>	<input type="checkbox"/>
S	LS SC BE C

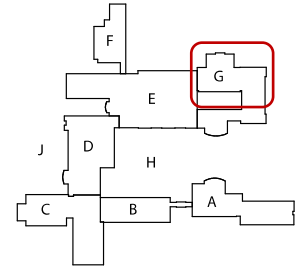

EXISTING CONDITIONS

HRU-8 and 9 are existing roof-mounted Z-Pack heat recovery units that appear to have been installed in 1994, and are at or near the end of their useful life. Exteriors are rusted and have been repainted. HRU-9 duct into sidewall of building is also due for replacement.



RECOMMENDATIONS

Replace the HRUs with units of similar design. Replace controls and associated duct and piping components. Include upgrades to ventilation and controls to meet current Codes and standards including the Maine Department of Education’s Public School Standards & Guidelines for New School Construction & Major Renovation Projects.

SCOPE OF WORK

Provide architectural and engineering services to verify performance requirements based on current use of the building, current mechanical codes, ventilation and energy efficiency standards, and other regulations and standards, in cooperation with the building users, and to design related architecture and structural supports. Remove existing RTUs, roof curbs, controllers and controlled devices, and remove associated ductwork and piping to the extent required. Install new RTUs with energy recovery, insulated roof curbs, and controls, new insulated outdoor ductwork, and reconnect to ductwork and piping. Provide architectural modifications, openings, and flashings. Provide structural support modifications and framed openings as required. Provide electrical power supplies. Provide variable frequency drives (VFDs) for speed control as applicable.

Provide New Heating in Band Room

Unit heaters are too loud
Must be turned off during classes

RELATED SCOPES OF WORK

Not Applicable

M-F113-M-2033	
Priority	Cost
	\$
Coordination by Discipline	
<input checked="" type="checkbox"/>	<input checked="" type="checkbox"/>
<input checked="" type="checkbox"/>	<input checked="" type="checkbox"/>
<input checked="" type="checkbox"/>	<input type="checkbox"/>
<input type="checkbox"/>	<input type="checkbox"/>
<input type="checkbox"/>	<input type="checkbox"/>
A	M
E	P
FP	
<input checked="" type="checkbox"/>	<input type="checkbox"/>
<input type="checkbox"/>	<input type="checkbox"/>
<input type="checkbox"/>	<input type="checkbox"/>
<input type="checkbox"/>	<input type="checkbox"/>
S	LS
SC	BE
C	

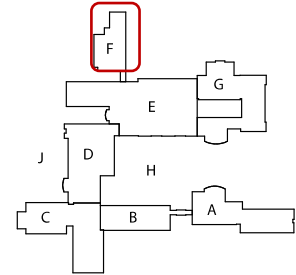

EXISTING CONDITIONS

The two unit heaters HUH-6 are loud, and must be turned off during classes.

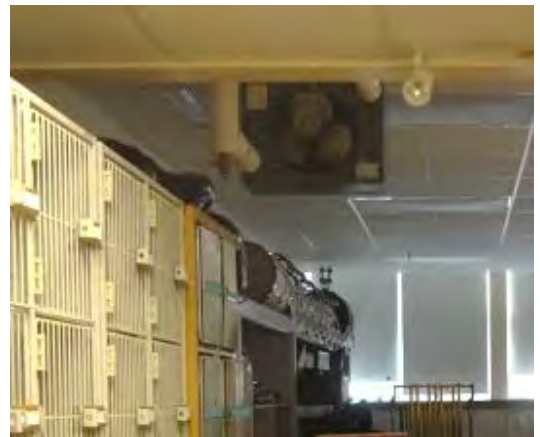

Unit heaters hung at ceiling are too loud.

RECOMMENDATIONS

Replace unit heaters HUH-6 (x2) in MS band with different units.

SCOPE OF WORK

Provide engineering services to determine suitable type and capacity of new heating units, in cooperation with the space users. Remove existing unit heaters, piping, and controls. Provide piping, and ductwork if required, to new heater locations. Install heaters, and connect to piping and ductwork. Provide controls. Provide architectural modifications as required to accommodate heaters. Provide electrical power supplies as necessary.

Provide Improved Auditorium Ventilation

Auditorium seems poorly ventilated
Air conditioning could be needed

RELATED SCOPES OF WORK

EM-D-A-3004
EM-ALL-M-3032

M-D154-M-2035	
Priority	Cost
	\$\$
Coordination by Discipline	
<input checked="" type="checkbox"/>	<input checked="" type="checkbox"/>
<input checked="" type="checkbox"/>	<input type="checkbox"/>
<input type="checkbox"/>	<input type="checkbox"/>
A	M
<input type="checkbox"/>	<input type="checkbox"/>
<input type="checkbox"/>	<input type="checkbox"/>
S	LS
<input type="checkbox"/>	<input type="checkbox"/>
SC	BE
<input type="checkbox"/>	<input type="checkbox"/>
C	

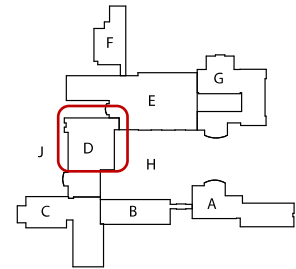

EXISTING CONDITIONS

Ventilation supply seems poor and ineffectively distributed per discussion with maintenance staff and user complaints. Air conditioning may be needed, pending airflow and space temperatures resulting from improved ventilation airflow.

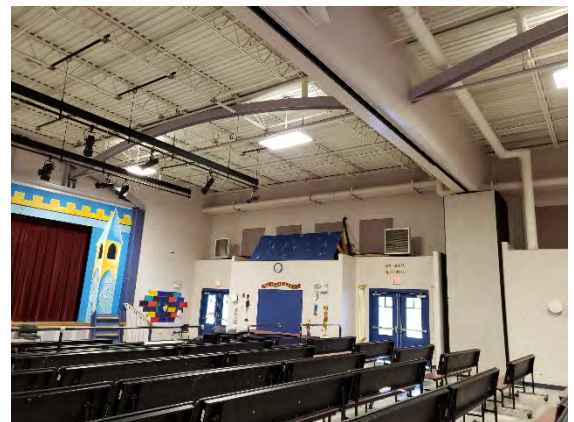

RECOMMENDATIONS

Increase ventilation quantity and distribution of outside air to the occupants to meet code required ventilation rates.

NEXT LEVEL

Provide air conditioning.

SCOPE OF WORK

1. Base Level – Provide additional supply air capacity, with upgraded supply air equipment, ductwork, and grilles or ceiling diffusers.
2. Next Level – Provide air conditioner, with outdoor or rooftop condensing units. Provide support and power and control wiring

Improve HVAC for 8th Grade Wing

HVAC and airflows are reportedly insufficient

RELATED SCOPES OF WORK

Not Applicable

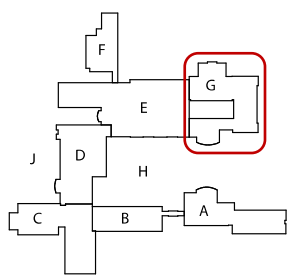
M-G-M-2038					
Priority	Cost				
	\$\$				
Coordination by Discipline					
<input checked="" type="checkbox"/>	<input checked="" type="checkbox"/>		<input checked="" type="checkbox"/>	<input type="checkbox"/>	<input type="checkbox"/>
A	M		E	P	FP
<input checked="" type="checkbox"/>	<input type="checkbox"/>	<input type="checkbox"/>	<input type="checkbox"/>	<input type="checkbox"/>	
S	LS	SC	BE	C	

EXISTING CONDITIONS

HVAC and airflows are reported by users to be insufficient.

RECOMMENDATIONS

Upgrade and replace systems as necessary.

SCOPE OF WORK

Provide architectural and engineering services to determine requirements in cooperation with the users. Provide upgrades and replacements as necessary. Provide controls, structural supports, and electrical power supplies.

Science Classroom Exhaust Hoods

Middle School science classrooms require exhaust hoods with makeup air

RELATED SCOPES OF WORK

Not Applicable

M-ALL-M-2039	
Priority	Cost
	\$\$\$
Coordination by Discipline	
<input checked="" type="checkbox"/>	<input checked="" type="checkbox"/>
<input checked="" type="checkbox"/>	<input checked="" type="checkbox"/>
<input checked="" type="checkbox"/>	<input type="checkbox"/>
<input type="checkbox"/>	<input type="checkbox"/>
<input type="checkbox"/>	<input type="checkbox"/>
<input type="checkbox"/>	<input type="checkbox"/>
<input type="checkbox"/>	<input type="checkbox"/>
S	C

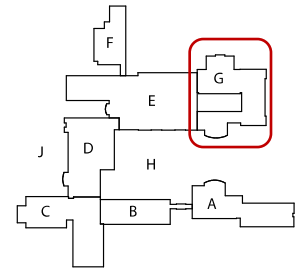

EXISTING CONDITIONS

There are currently no fume hoods located in the middle school science classrooms.

RECOMMENDATIONS

Provide a built-in fume hood and sufficient ventilation system for each science laboratory classroom to meet code requirements and improve student safety. ASHRAE 62.1 requires 10 cfm per person and 0.18 cfm per square foot of ventilation air, and 1 cfm per square foot exhaust rate.

SCOPE OF WORK

Provide built-in fume hood and ventilation for science laboratory classrooms. Provide ventilation at a rate of 10 cfm per person and 0.18 cfm per square foot and provide exhaust at a rate of 1 cfm per square foot. Provide fans, ductwork, and controls. Provide trim and miscellaneous architectural work to support installation of the fume hood. Provide electrical power supplies.

Improve HVAC for Special Education Wing

HVAC and airflows are reportedly insufficient

RELATED SCOPES OF WORK

Not Applicable

M-G-M-2040				
Priority	Cost			
	\$\$			
Coordination by Discipline				
<input checked="" type="checkbox"/>	<input checked="" type="checkbox"/>	<input checked="" type="checkbox"/>	<input type="checkbox"/>	<input type="checkbox"/>
A	M	E	P	FP
<input checked="" type="checkbox"/>	<input type="checkbox"/>	<input type="checkbox"/>	<input type="checkbox"/>	<input type="checkbox"/>
S	LS	SC	BE	C

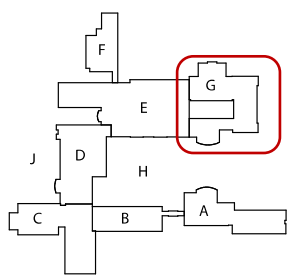

The diagram shows a floor plan with rooms labeled A through J. Room G is circled in red. The layout includes rooms A, B, C, D, E, F, G, H, and J, with room G being a central room connected to others.

EXISTING CONDITIONS

HVAC and airflows are reported by users to be insufficient.

RECOMMENDATIONS

Upgrade and replace systems as necessary.

SCOPE OF WORK

Provide architectural and engineering services to determine requirements in cooperation with the users. Provide upgrades and replacements as necessary. Provide controls, structural supports, and electrical power supplies.

Improve HVAC Control to Foreign Language

HVAC and airflows are reportedly insufficient

RELATED SCOPES OF WORK

Not Applicable

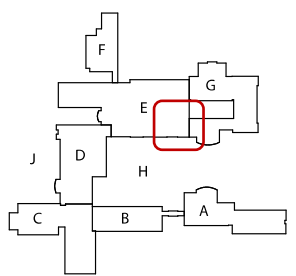
M-E148-M-2041					
Priority	Cost				
	\$				
Coordination by Discipline					
<input checked="" type="checkbox"/>	<input checked="" type="checkbox"/>		<input checked="" type="checkbox"/>	<input type="checkbox"/>	<input type="checkbox"/>
A	M		E	P	FP
<input checked="" type="checkbox"/>	<input type="checkbox"/>	<input type="checkbox"/>	<input type="checkbox"/>	<input type="checkbox"/>	
S	LS	SC	BE	C	

EXISTING CONDITIONS

HVAC and airflows are reported by users to be insufficient.

RECOMMENDATIONS

Upgrade and replace systems as necessary.

SCOPE OF WORK

Provide architectural and engineering services to determine requirements in cooperation with the users. Provide upgrades and replacements as necessary. Provide controls, structural supports, and electrical power supplies.

Increase Media Center Cooling

Cooling and airflows are reportedly insufficient

RELATED SCOPES OF WORK

M-ROOF-M-2022

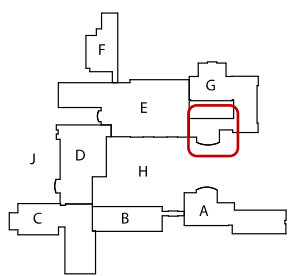
M-G141-M-2042				
Priority	Cost			
	\$\$			
Coordination by Discipline				
<input checked="" type="checkbox"/>	<input checked="" type="checkbox"/>		<input checked="" type="checkbox"/>	<input checked="" type="checkbox"/>
A	M	E	P	FP
<input checked="" type="checkbox"/>	<input type="checkbox"/>	<input type="checkbox"/>	<input type="checkbox"/>	<input type="checkbox"/>
S	LS	SC	BE	C

EXISTING CONDITIONS

Cooling and airflows are reported by users to be insufficient. Room has a lot of glass, skylight, and added loads from electronics.



RECOMMENDATIONS

Upgrade and replace systems as necessary.

SCOPE OF WORK

Provide architectural and engineering services to determine requirements in cooperation with the users. Provide upgrades and replacements as necessary. Provide controls, structural supports, and electrical power supplies.

Replace Cabinet Unit Heaters at Entry

Heaters are worn and rusted

RELATED SCOPES OF WORK

Not Applicable

M-D116-M-2043				
Priority	Cost			
	\$			
Coordination by Discipline				
<input checked="" type="checkbox"/>	<input checked="" type="checkbox"/>	<input checked="" type="checkbox"/>	<input type="checkbox"/>	<input type="checkbox"/>
A	M	E	P	FP
<input type="checkbox"/>	<input type="checkbox"/>	<input type="checkbox"/>	<input type="checkbox"/>	<input type="checkbox"/>
S	LS	SC	BE	C

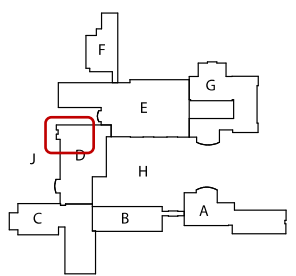

EXISTING CONDITIONS

In Entry D116, the 2 cabinet unit heaters CUH-10 on both sides of the entry doors are plugged with dirt and debris, and rusted from moisture and floor cleaning. Bottom protective grille is missing from one heater.



RECOMMENDATIONS

Replace the heaters with new equivalent, with tamper-resistant covers to prevent unauthorized access to controls.

SCOPE OF WORK

Remove heaters. Remove piping, and power and control wiring, as necessary. Patch adjacent building walls and floor as necessary. Install heaters, piping, controls, and accessories. Reconnect power wiring. Balance air and water flows.

Repairs at Water Heaters

Some leaks. Neutralizers not serviceable.
Mixing valves outdated.

RELATED SCOPES OF WORK

EM-G-P-3049

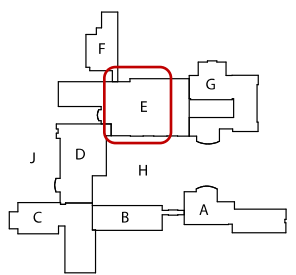
M-E163-P-2044		
Priority	Cost	
	\$	
Coordination by Discipline		
<input checked="" type="checkbox"/> <input type="checkbox"/> <input checked="" type="checkbox"/> <input checked="" type="checkbox"/> <input type="checkbox"/> A M E P FP		
<input type="checkbox"/> <input type="checkbox"/> <input type="checkbox"/> <input type="checkbox"/> <input type="checkbox"/> S LS SC BE C		

EXISTING CONDITIONS

Condensate drain neutralizer cartridges for the Rinnai gas-fired instantaneous water heaters are not removable, and so likely haven't been serviced since installation; marble neutralizer chips are likely used up; cast iron floor drainage piping possibly corroded by untreated acidic condensate. Solar water tank piping has a failed union. Thermostatic mixing valves for domestic hot water supply show significant age, predating the solar and gas water heating, and likely contain some lead because they predate current lead-free regulations.



RECOMMENDATIONS

Replace condensate neutralizers with serviceable type. Repair underslab piping as needed. Repair piping union. Replace mixing valves for both the domestic water and the dishwasher water supply.

SCOPE OF WORK

Provide engineering services to recommend repairs and replacements in cooperation with building users. Inspect underslab piping to determine extent of corrosion. Remove piping and equipment as necessary, and install repairs and replacements. Neutralizers may be individual for each heater, or a larger combined one, with unions in piping to allow service and removal. Size thermostatic mixing valves for the current and anticipated water usage. Provide piping insulation and protective PVC jacket and fitting system on water piping. Provide electrical power supplies as required.

Replace Corroded Kitchen Gas and Water Piping

Piping is aged and in poor condition

RELATED SCOPES OF WORK

M-D129-A-2000

M-D131-P-2049

M-D131-P-2045				
Priority	Cost			
	\$			
Coordination by Discipline				
<input checked="" type="checkbox"/>	<input type="checkbox"/>	<input checked="" type="checkbox"/>	<input checked="" type="checkbox"/>	<input type="checkbox"/>
A	M	E	P	FP
<input type="checkbox"/>	<input type="checkbox"/>	<input type="checkbox"/>	<input type="checkbox"/>	<input type="checkbox"/>
S	LS	SC	BE	C

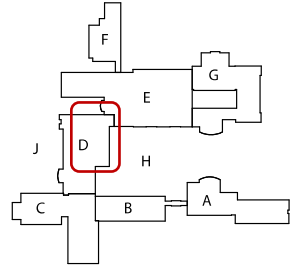

EXISTING CONDITIONS

The kitchen space serving the combined elementary and middle school cafeteria has exposed piping throughout, including both natural gas service piping and domestic water piping. Due to the relatively extreme environment these pipes have been exposed to in the kitchen, many are showing significant signs of corrosion and aging.

RECOMMENDATIONS

Replace exposed corroded natural gas and domestic hot and cold-water piping throughout kitchen. Provide flexible braided hose connections at equipment for ease of connection. Replace valves, filters, and filter cartridges in kind.

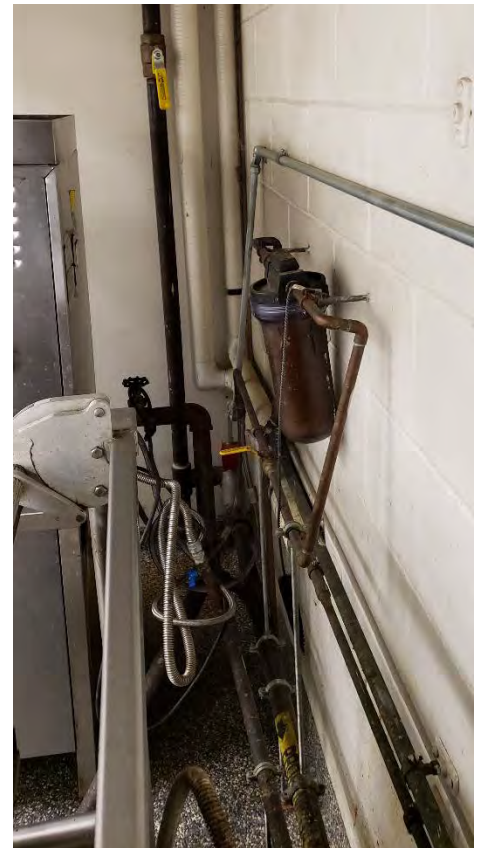

SCOPE OF WORK

Provide piping to replace all exposed natural gas and domestic hot and cold-water piping throughout kitchen spaces serving the combined elementary and middle school cafeteria. Replace in kind, and provide flexible braided hose connections at kitchen equipment. Replace valves, filters, and filter cartridges in kind. Support piping per manufacturer recommendations and per 2015 Uniform Plumbing Code table 313.3 for domestic water piping and table 1210.2.4.1 for gas piping.

Replace Art Room Sinks

Sinks are not ADA accessible
 Added sinks can't drain properly

RELATED SCOPES OF WORK

Not Applicable

M-E160-P-2046	
Priority	Cost
	\$
Coordination by Discipline	
<input checked="" type="checkbox"/>	<input type="checkbox"/>
<input type="checkbox"/>	<input checked="" type="checkbox"/>
<input type="checkbox"/>	<input type="checkbox"/>
A	M
<input type="checkbox"/>	<input type="checkbox"/>
<input type="checkbox"/>	<input type="checkbox"/>
S	LS
<input type="checkbox"/>	<input type="checkbox"/>
SC	BE
<input type="checkbox"/>	<input type="checkbox"/>
C	

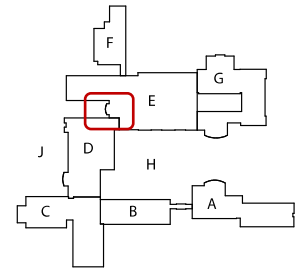

EXISTING CONDITIONS

Sinks have deep bowls, rim heights, leg spacing, pipe routing, and floor-mounted pipe supports which do not conform to ADA accessibility guidelines. Two of the sinks are plastic laundry-tray type which appear to have been added later; they are lower than the older stainless steel sinks. The sinks share a plaster trap and wall sanitary pipe connection; the bottoms of the plastic sinks are at about the height of the wall pipe connection which inhibits draining. The faucets on the plastic sinks have short non-ADA handles, and hose-thread outlets without vacuum breakers to prevent cross-contamination.



RECOMMENDATIONS

Replace the sinks, faucets, traps, and piping. Select sinks and faucets to provide accessibility and utility for the anticipated classroom tasks. Consider fully wall-hung sinks if the CMU partition can support them, for least restrictive floor space. Provide faucets with plain outlets, or if hose attachment is desired provide vacuum breakers. Sensor-operated hands-free faucets may be considered. Provide drain outlets with stoppers or other devices as needed, and to meet ADA requirements where applicable. Provide ADA-compliant guards on piping and other surfaces within knee spaces under the sinks. Provide quantity of plaster/sediment traps to suit the usage and as required by Code. Modify sanitary piping in the wall to provide a connection lower than the trap outlets.

SCOPE OF WORK

Provide architectural services to determine ADA accessibility requirements and to verify classroom needs in cooperation with school staff. Remove the sinks, faucets, and exposed drain and water piping. Provide an opening in the CMU partition to access the sanitary and vent piping, and remove piping as required. Modify the sanitary and vent piping within the partition to provide a connection lower than the trap outlets, and patch the CMU partition. Provide wall support blocking as required, and patch and paint the CMU. Provide sinks and faucets, water piping with shutoff valves to each faucet, sanitary drain piping with offset tailpieces toward the partition to clear the accessible knee spaces, and plaster/sediment traps in the quantity required to suit the usage and to comply with Codes. Provide ADA-compliant guards on piping and other surfaces within knee spaces under the sinks.

Provide Sufficient Hot Water to Showers

Hot water is reportedly lacking at locker rooms

RELATED SCOPES OF WORK

Not Applicable

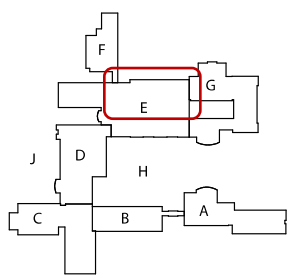
M-E-P-2047					
Priority	Cost				
	\$				
Coordination by Discipline					
<input checked="" type="checkbox"/>	<input type="checkbox"/>		<input checked="" type="checkbox"/>	<input checked="" type="checkbox"/>	<input type="checkbox"/>
A	M		E	P	FP
<input type="checkbox"/>	<input type="checkbox"/>	<input type="checkbox"/>	<input type="checkbox"/>	<input type="checkbox"/>	
S	LS	SC	BE	C	

EXISTING CONDITIONS

Hot water supply to locker room showers is reportedly poor or nonexistent.

RECOMMENDATIONS

Repair or upgrade system to provide adequate hot water. Provide recirculation to the fixtures farthest from the water heaters, to reduce wait time.

SCOPE OF WORK

Provide engineering services to recommend repairs and replacements in cooperation with building users. Remove piping and equipment as necessary, and install repairs and replacements. Provide electrical power supplies as required.

Faucets and Filters for Special Education

Faucets are inappropriate type
Water taste needs improvement

RELATED SCOPES OF WORK

M-E109-LS-2019

M-G-P-2048				
Priority	Cost			
	\$			
Coordination by Discipline				
<input checked="" type="checkbox"/>	<input type="checkbox"/>		<input checked="" type="checkbox"/>	<input checked="" type="checkbox"/>
A	M	E	P	FP
<input type="checkbox"/>	<input type="checkbox"/>	<input type="checkbox"/>	<input type="checkbox"/>	<input type="checkbox"/>
S	LS	SC	BE	C

EXISTING CONDITIONS

Faucets are reportedly not suitable type or condition for the special education use. The taste of the tap water is not as good as desired for the use which includes life skills cooking.

RECOMMENDATIONS

Replace faucets – automatic sensor type may be recommended, as noted in another work item. Provide water filtration for taste.

SCOPE OF WORK

Provide architectural and engineering services to recommend repairs and replacements in cooperation with building users. Remove faucets and remove piping as necessary, and install new faucets and filters. Provide electrical power supplies as required.

Provide Adequate Kitchen Sinks

Kitchen sinks lack proper drainage and separation of functions

RELATED SCOPES OF WORK

M-D131-P-2045

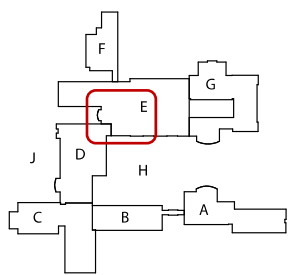
M-D131-P-2049				
Priority	Cost			
	\$\$			
Coordination by Discipline				
<input checked="" type="checkbox"/>	<input type="checkbox"/>	<input checked="" type="checkbox"/>	<input checked="" type="checkbox"/>	<input type="checkbox"/>
A	M	E	P	FP
<input type="checkbox"/>	<input type="checkbox"/>	<input type="checkbox"/>	<input type="checkbox"/>	<input type="checkbox"/>
S	LS	SC	BE	C

EXISTING CONDITIONS

Kitchen sinks do not provide proper separation of dishwashing and other unsanitary functions from food preparation such as washing vegetables to be served uncooked. The single 2-bay lacks indirect waste and is piped directly to the sanitary system. Warewashing sink booster heater is beyond its expected useful life; there doesn't appear to be an alternative such as a chemical sanitizing system.



RECOMMENDATIONS

Provide adequate separate sinks and indirect wastes for proper sanitation. Provide functioning pot sink booster heater.

SCOPE OF WORK

Provide additional sinks to separate functions. For the sinks used for food preparation, pipe the drains to indirect waste with air gap to prevent the backup of sewage or gases into the sink, as required by Maine's Uniform Plumbing Code 2015 Chapter 801.3.3 Food Handling Fixtures. Remove the booster heater and provide new with accessories as required, to meet the manual warewashing sanitation requirements of the Maine Food Code.

General Classroom Appearance

RELATED SCOPES OF WORK

- EM-ALL-A-3002
- EM-ALL-E-3016
- E-ALL-P-1024

EM-ALL-A-3000				
Priority	Cost			
	\$\$\$\$			
Coordination by Discipline				
<input checked="" type="checkbox"/>	<input type="checkbox"/>	<input checked="" type="checkbox"/>	<input checked="" type="checkbox"/>	<input type="checkbox"/>
A	M	E	P	FP
<input type="checkbox"/>	<input type="checkbox"/>	<input type="checkbox"/>	<input type="checkbox"/>	<input type="checkbox"/>
S	LS	SC	BE	C

EXISTING CONDITIONS

- a. Classrooms are well maintained, but finishes and fixtures are worn, dated, or require extensive amount of maintenance or are inefficient.
- b. Millwork is worn and feels dated. Many units are missing components. In some locations, shelving is extremely bowed or doors are miss-aligned.
- c. Some furnishings (notably seating) has been upgraded in some classrooms.



RECOMMENDATIONS

- a. See Finished Flooring and Lighting improvement items noted above. At a minimum, replace acoustical ceiling tiles that are broken or damaged. Replacement of all acoustical ceiling tiles would update the classrooms aesthetically, however would not likely provide any functional improvement.
- b. Repair or replace missing millwork components. Replace sagging shelves and failing hardware, level doors and drawers. Consider replacing top surfaces where worn.
- c. Continue replacement of furnishings throughout.

Conduit Penetrations at Corridor

RELATED SCOPES OF WORK
EM-ALL-FP-3054

EM-ALL-LS-3001				
Priority		Cost		
		\$\$		
Coordination by Discipline				
<input checked="" type="checkbox"/>	<input type="checkbox"/>	<input checked="" type="checkbox"/>	<input type="checkbox"/>	<input checked="" type="checkbox"/>
A	M	E	P	FP
<input type="checkbox"/>	<input checked="" type="checkbox"/>	<input type="checkbox"/>	<input type="checkbox"/>	<input type="checkbox"/>
S	LS	SC	BE	C

EXISTING CONDITIONS

- a. Sealant appears missing at some conduit penetrations above ACT ceiling. In some cases this happens at corridor walls where smoke separation is required.



RECOMMENDATIONS

- a. Electrical contractor to survey all penetration locations and seal those where smoke separation is required. Where penetrations exist between classroom spaces, provide sealant to reduce noise transfer between classrooms.

SCOPE OF WORK

- a. Full extent of work not known at this time. Electrical contractor to review and provide estimate.

General Flooring Repair and Upgrades

RELATED SCOPES OF WORK
EM-ALL-A-3000

EM-ALL-A-3002				
Priority	Cost			
	\$\$\$\$			
Coordination by Discipline				
<input checked="" type="checkbox"/>	<input type="checkbox"/>	<input type="checkbox"/>	<input type="checkbox"/>	<input type="checkbox"/>
A	M	E	P	FP
<input checked="" type="checkbox"/>	<input type="checkbox"/>	<input checked="" type="checkbox"/>	<input type="checkbox"/>	<input type="checkbox"/>
S	LS	SC	BE	C

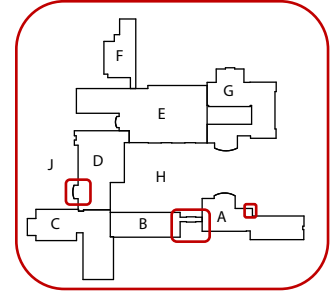

EXISTING CONDITIONS

- a. A Wing Ramp - Rubber finished flooring is separating from sub-floor which presents a tripping hazard. Adjacent Rubber base is damaged. Rubber is generally exhibiting wear and tear.
- b. Corridor (connector between A and B wing) – Vinyl flooring exhibits stress fractures and is faded from the sun.
- c. D Wing Corridor: Slab Cracking is telegraphing through VCT tiles at middle of ramp
- d. General:
 - Existing VCT tile has high annual maintenance cost. Cleaning process takes significant manpower and time and entire sections of the building are unusable for the duration of maintenance.
 - Square Ceramic Tile (Large and Small Format) – Existing tile is in good condition and is extremely durable, although does not convey an updated appearance.

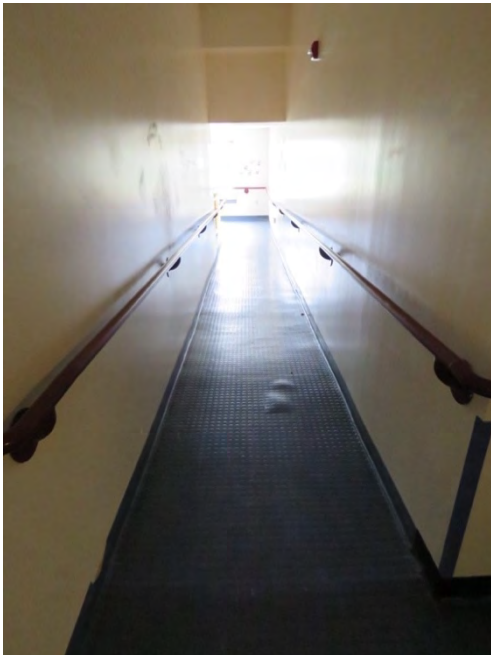

Cape Elizabeth Schools Needs Assessment



RECOMMENDATIONS

- A) Wing A: Repair or replace rubber flooring and base trim at ramp.

NEXT LEVEL

- B) Replace vinyl flooring throughout school. This could be done one wing at a time.
Wing A (12,650 SF), Wing B (9,400 SF), Wing C (26,650 SF), Wing D (9,000 SF), Wing E (20,000 SF),
Wing F (8,400 SF), Wing G (32,250 SF)
- C) If new entry is being constructed, consider upgrading 12"x12" ceramic tile at that time.

SCOPE OF WORK

- A) Wing A: Repair or remove and replace rubber sheet good per manufacturer's recommendation. Replace sections of rubber base where damaged. Recycle existing materials removed from space.
- B) Remove and replace vinyl flooring in entirety of wing. Recycle existing materials removed from space where possible. Prep sub-floor to receive new finished flooring. In Wing D, repair concrete slab with grout and skim coat before new VCT tile is installed.

Door Compliance Issues

RELATED SCOPES OF WORK

Not Applicable

EM-ALL-A-3003				
Priority	Cost			
	\$			
Coordination by Discipline				
<input checked="" type="checkbox"/>	<input checked="" type="checkbox"/>	<input type="checkbox"/>	<input type="checkbox"/>	<input type="checkbox"/>
A	M	E	P	FP
<input type="checkbox"/>	<input checked="" type="checkbox"/>	<input type="checkbox"/>	<input type="checkbox"/>	<input type="checkbox"/>
S	LS	SC	BE	C

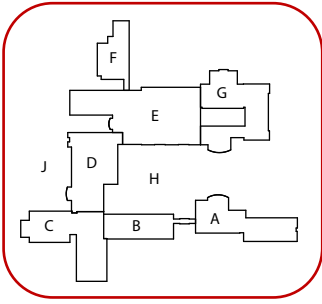

EXISTING CONDITIONS

- Door thresholds are limited to 1/2" high per ADA 303.3.
- ADA Requirement: Doors with closers must have clear width at the latch side of the door. On the pull side, the required width is 18"; on the push side 12".
- ADA Requirement: Doors in series must have 48" clear between the doors. The door swings cannot impede on this requirement.
- Transfer grilles through doors for transfer of exhaust make-up air is not allowed by Life Safety Code.

RECOMMENDATIONS

- Replace door threshold with ADA compliant threshold, beveled at each side.
- Investigate if changes can be made to accommodate ADA clearance requirements.
- Investigate if changes can be made to accommodate ADA doors in series requirements.
- Coordinate with mechanical engineer to determine if door vent is part of active mechanical design.
 - If not, block door vents to prevent transfer of smoke in a life safety situation.
 - If so, block door vent. Install new transfer grille in wall with smoke damper tied to fire alarm system.

SCOPE OF WORK

	Install ADA Threshold	Fix ADA Clearance	ADA Doors in Sequence	Door Vent	Notes
Room A109	--	--	c.	--	
Room A114	--	b.	--	--	Interior side is not compliant.
Room A118	--	b.	--	--	Interior side is not compliant.
Room B101	--	b.	--	--	Lockers encroach on 18" clearance.
Room B102	--	b.	--	--	Lockers encroach on 18" clearance.
Room B103	--	b.	--	--	Lockers encroach on 18" clearance.
Room B105	--	b.	--	--	
Room B106	--	--	--	--	Door deterioration at interior face.
Room B107	--	b.	--	--	
Room B114	--	b.	--	--	Lockers encroach on 18" clearance.
Room B115	--	b.	--	d.	Lockers encroach on 18" clearance.
Room C223	--	b.	--	--	Pull side is not compliant.
Room E118	--	b.	--	--	Pull side is not compliant.
Room G123	a.	--	--	--	
Room G132	a.	--	--	--	

Renovate Auditorium and Support Spaces

EM-D-A-3004				
Priority	Cost			
	\$\$\$\$			
Coordination by Discipline				
<input checked="" type="checkbox"/>	<input checked="" type="checkbox"/>	<input checked="" type="checkbox"/>	<input checked="" type="checkbox"/>	<input checked="" type="checkbox"/>
A	M	E	P	FP
<input checked="" type="checkbox"/>	<input checked="" type="checkbox"/>	<input checked="" type="checkbox"/>	<input type="checkbox"/>	<input type="checkbox"/>
S	LS	SC	BE	C

RELATED SCOPES OF WORK

EM-NEW-A-3005
M-D154-M-2035

EXISTING CONDITIONS

The existing space is both a cafeteria and an auditorium (cafetorium) utilized by both the Middle School and Pond Cove Elementary School for daily lunch and periodic auditorium presentations. The space has three level changes, each separated by “aisles” with two stair risers – and with railings to prevent tripping at the level changes.

In its capacity as an auditorium:

- There is no dedicated space for a control / lighting booth.
- Dual use of tables/benches for both cafeteria and auditorium uses requires constant rearranging.
- Floor rise is insufficient.
- Stage is undersized.
- Acoustic treatments are needed.
- There is inadequate support space (green rooms, dressing rooms, etc.)
- Transition between dining and performance uses requires considerable time.

RECOMMENDATIONS

Pursuant to Work Item EM-NEW-A-3005, the design team recommends constructing a new kitchen and separate middle school and lower school dining rooms. If the dining and kitchen functions are removed from this space, the design team recommends auditorium renovations in support of making the space a dedicated performance space. Renovations would include:

- Control booth
- Catwalks
- 600-650 fixed seats
- Green room
- Classrooms
- Dressing rooms
- Stage storage
- Offices



NEXT LEVEL

There is some adjacency benefit of having the band and music rooms near the stage. While there is insufficient space for this adjacency through renovation alone, it’s possible that colocation of the band/music programs and the auditorium could take place with an addition into the courtyard.

SCOPE OF WORK

- Architectural: See plan diagram on reverse side for scope of work.
- Fire Protection: Provide sprinkler fire protection systems.
- Mechanical: Provide engineering services to design plumbing and HVAC. Provide quiet HVAC systems (air conditioning recommended for some spaces) with air-to-air energy recovery and occupancy-based control (such as CO2 monitoring) for the ventilation air.
- Electrical: Provide engineering services to design electrical lighting, power, and related systems.

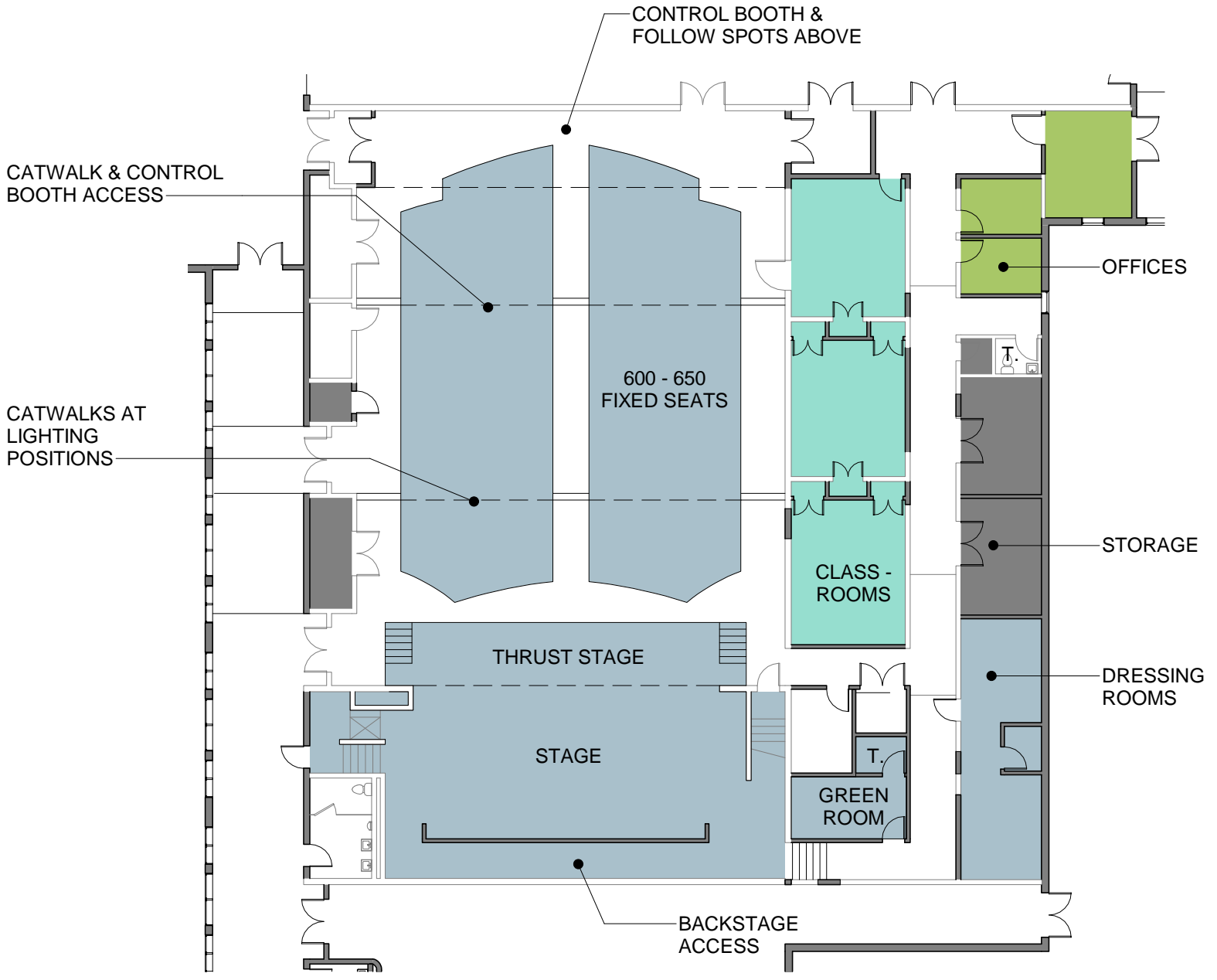

New Cafeteria and Kitchen

RELATED SCOPES OF WORK

EM-D-A-3004

EM-NEW-A-3005				
Priority	Cost			
	\$\$\$\$			
Coordination by Discipline				
<input checked="" type="checkbox"/>	<input checked="" type="checkbox"/>	<input checked="" type="checkbox"/>	<input checked="" type="checkbox"/>	<input checked="" type="checkbox"/>
A	M	E	P	FP
<input checked="" type="checkbox"/>	<input checked="" type="checkbox"/>	<input checked="" type="checkbox"/>	<input checked="" type="checkbox"/>	<input checked="" type="checkbox"/>
S	LS	SC	BE	C

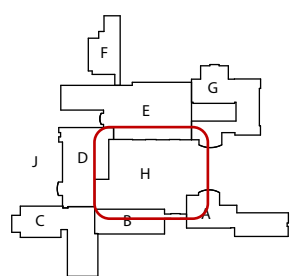

EXISTING CONDITIONS

The existing space is both a cafeteria and an auditorium (cafetorium) utilized by both the Middle School and Pond Cove Elementary School for daily lunch and periodic auditorium presentations. The space has three level changes, each separated by “aisles” with two stair risers – and with railings to prevent tripping at the level changes.

In its capacity to serve lunch, the kitchen is undersized, which requires extending the serving space into the cafetorium. The floor level changes limit flexibility of table placement, while also creating life safety egress and ADA compliance issues. Kitchen service and trash removal must cross paths with students, which creates both safety and building access concerns.

Scheduling of lunches – (2) 20-minute seatings for the middle school and (3) 25-minute seatings for the lower school – dictates scheduling for the remainder of the both schools.

In its capacity as an auditorium:

- There is no dedicated space for a control / lighting booth.
- Dual use of tables/benches for both cafeteria and auditorium uses requires constant rearranging.
- Floor rise is insufficient.
- Stage is undersized.
- Acoustic treatments are needed.
- There is inadequate support space (green rooms, dressing rooms, etc.)
- Transition between dining and performance uses requires considerable time.

RECOMMENDATIONS

The design team recommends constructing a new kitchen and separate middle school and lower school dining rooms. The recommended location is in the existing courtyard framed by the middle school and lower school wings of the building, thereby accessible from both schools. Constructing a new kitchen will allow use of the existing kitchen while the addition is constructed. Service to the new kitchen will come from the existing fire department access road, thereby eliminating the need to cross paths with students.

A diagrammatic layout is provided on the back-side of this sheet.

SCOPE OF WORK

The addition would include the following:

- New kitchen and serving lines, approx. 8,000sf.
- New middle school dining room, 4500-6000sf depending on the necessity for one or two middle school lunches daily.
- (2) New lower school dining rooms, each approx. 1500sf.

Fire Protection: Provide sprinkler fire protection systems.

Mechanical: Provide engineering services to design plumbing and HVAC. For HVAC in the dining rooms, provide air-to-air energy recovery and occupancy-based control (such as CO2 monitoring) for the ventilation air. For HVAC in the kitchen, provide variable exhaust and makeup air for the kitchen hoods, using temperature sensors in the hoods.

Electrical: Provide engineering services to design electrical lighting, power, and related systems.

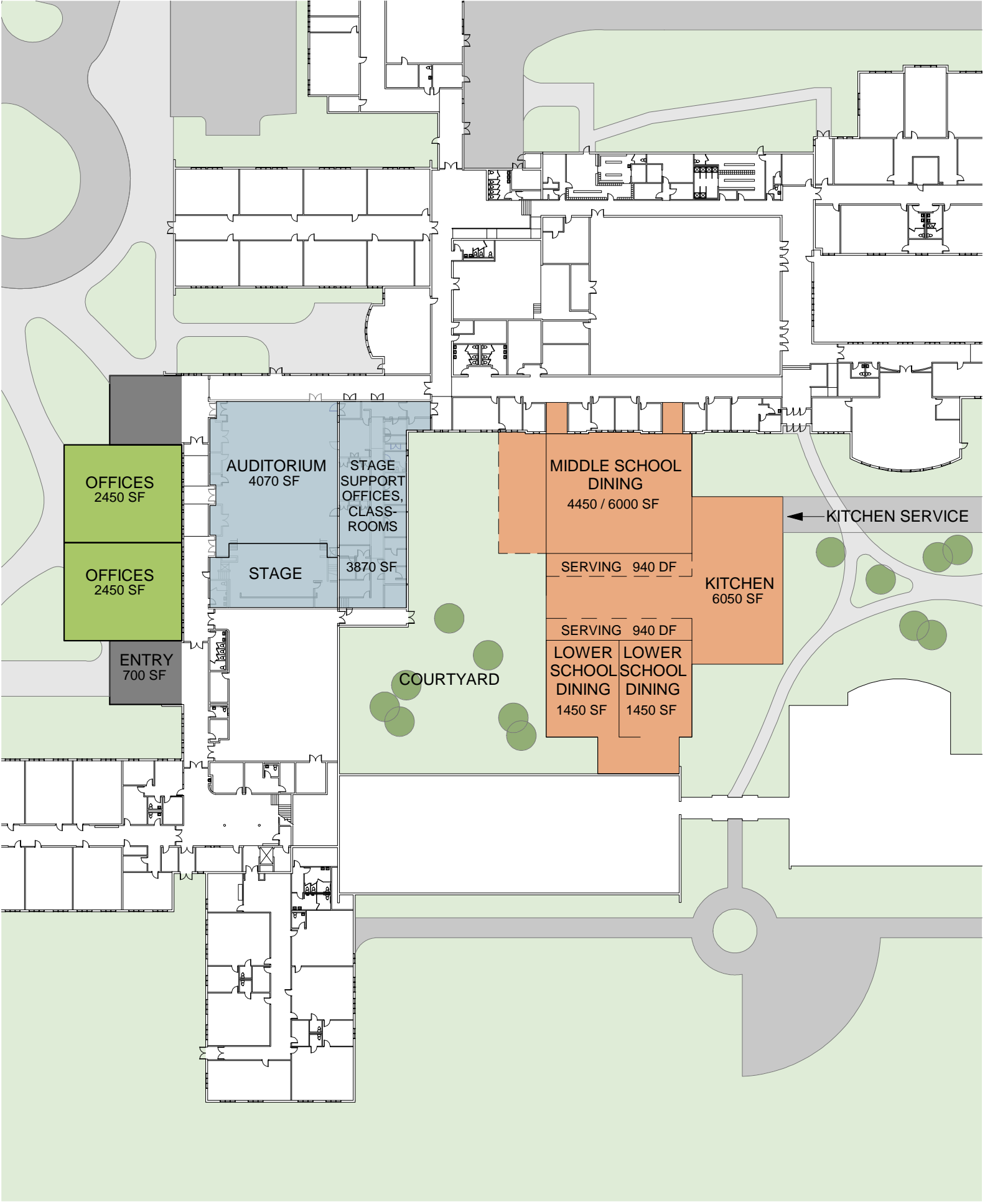

General ADA Compliance: Restrooms

RELATED SCOPES OF WORK

Not Applicable

EM-ALL-A-3006				
Priority	Cost			
	\$			
Coordination by Discipline				
<input checked="" type="checkbox"/>	<input type="checkbox"/>	<input type="checkbox"/>	<input checked="" type="checkbox"/>	<input type="checkbox"/>
A	M	E	P	FP
<input type="checkbox"/>	<input type="checkbox"/>	<input type="checkbox"/>	<input type="checkbox"/>	<input type="checkbox"/>
S	LS	SC	BE	C

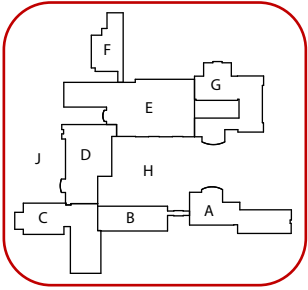

EXISTING CONDITIONS

- General mounting heights of paper towels dispensers, soap dispenser do not conform to ADA mounting heights.
- Insulation shrouds are missing or provide partial coverage for sink waste lines.
- Toilet paper dispenser type prevents proper ADA mounting height due to conflict with grab bar location.
- Adult ADA standards applied to plumbing fixtures, mirrors, dispensers, and grab bars.
- Door swings for some restroom doors lack adequate clearance on the pull side jamb, Toilets C130 & C132.

RECOMMENDATIONS

- Adjust mounting heights to conform with ADA mounting heights, ADA 604.9
- Survey and confirm all waste lines at accessible sinks have the proper full coverage of waste lines in compliance with ADA 606.5 Exposed Pipes and Surfaces.
- Provide an alternate type of toilet paper dispenser that can be mounted at the proper height.
- Plumbing fixture, mirrors, dispenser and grab bars should all be positioned according to Accessible Mounting Heights for School Age Children. See attached. Since the grade range for each school wing is known, restrooms within those areas should have accessibility standards for that age range.
- Consider re-swinging the door direction at restroom entries.



ACCESSIBLE MOUNTING HEIGHTS for VARIOUS SCHOOL AGE STUDENTS

alphaOne

Powering Independent Living

	<u>Pre-Kindergarten</u> Ages - 3 thru 5	<u>K to 2</u> 6 thru 8	<u>3 to 6</u> 9 thru 12
Ramp handrails (intermediate rail in addition to standard 34" high rail)	20"	24"	28"
Stair handrails (same as above)	20"	24"	28"
Forward reach (max/min)	36"/20"	40"/18"	44"/16"
Side reach (max/min)	36"/20"	40"/18"	44"/16"
Sinks	-----	31" max w/ 24" knee clearance	
Water Closet Mounting	12" (c/l to wall)	12" to 15"	15" to 18"
Water Closet Seat	11" to 12"	12" to 15"	15" to 17"
Water Closet Grab Bar	18" to 20"	20" to 25"	25" to 27"
Water Closet Grab Bar (rear)	36" minimum and/or 4" above tank cover		
Grab Bar & Handrail Dia.	1"	----- 1" to 1 1/4"-----	
Flush Controls [max/min]	36"/20"	40"/18"	44"/16"
Lavatory Height	31" (max)	31" (max)	31" (max)
Apron Clearance	-----	27" (min)	27" (min)
Knee Clearance	-----	24" (min)	24" (min)
Mirrors	-----34" maximum above finish floor-----		
Dispensers	14" a.f.f.	14" to 17" a.f.f.	17" to 19" a.f.f.
Shower Seats	11" to 12" a.f.f.	12" to 15" a.f.f.	15" to 17" a.f.f.
Shower Controls	36" (max)	40" (max)	44" (max)
Urinals [rim height]	---	14"	14"
Drinking Fountains	30" (max)	30" (max)	30" (max)
Controls (max/min)	36"/20"	40"/18"	44"/16"
Seating/Tables/Work Surf.	26"	28"	30"
Knee Clearance	--	24"	24"
Chalkboards (tray height)	--	24"	36"
Storage Shelves	-----36" (max) to 20" (min)-----		
Coat Hooks / Rods	36" (max)	36" (max)	36" (max)
Door Hardware	36" (max)	36" (max)	36" (max)
Signage	48" (max)	48" (max)	48" (max)

Note: Mounting heights above incorporate ADAAG for Children's Environments per final rule dtd January 13, 1998 and anticipated enactment and enforceability in the new ADA / ABAAG to soon be enacted by the DOJ

General ADA Compliance: Classrooms

RELATED SCOPES OF WORK
E-ALL-P-1024

EM-ALL-A-3007				
Priority	Cost			
	\$			
Coordination by Discipline				
<input checked="" type="checkbox"/>	<input type="checkbox"/>	<input type="checkbox"/>	<input checked="" type="checkbox"/>	<input type="checkbox"/>
A	M	E	P	FP
<input type="checkbox"/>	<input type="checkbox"/>	<input type="checkbox"/>	<input type="checkbox"/>	<input type="checkbox"/>
S	LS	SC	BE	C

EXISTING CONDITIONS

- a. Adult ADA standards applied to Classroom Casework, Sinks and Dispensers.
- b. Depth of sink exceeds standard of ADA
- c. Exposed waste piping at multiple locations throughout the lower school.
- d. Improper height for soap, sanitizer and paper towel dispensers. Sink and dispensers are accessed by students using movable wooden steps.



Example non-ADA compliant classroom sink, E109

RECOMMENDATIONS

- a. See attached Accessible Mounting Heights for Various School Age Students. Where the ages of students within each classroom are known, accessibility should be sized to fit the user groups.
- b. Survey and correct all waste pipe insulation at all accessible sinks throughout the Lower School

General ADA Compliance: Corridors

RELATED SCOPES OF WORK

Not Applicable

EM-ALL-A-3008				
Priority	Cost			
	\$\$			
Coordination by Discipline				
<input checked="" type="checkbox"/>	<input type="checkbox"/>	<input checked="" type="checkbox"/>	<input type="checkbox"/>	<input type="checkbox"/>
A	M	E	P	FP
<input type="checkbox"/>	<input checked="" type="checkbox"/>	<input type="checkbox"/>	<input type="checkbox"/>	<input type="checkbox"/>
S	LS	SC	BE	C

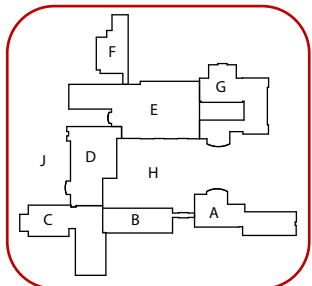

EXISTING CONDITIONS

a. Protruding Objects:

ADA Section 309 reads: Objects with leading edges more than 27 inches and not more than 80 inches above the finish floor or ground shall protrude 4 inches maximum horizontally into the circulation path.

Many corridor display cases protrude beyond the 4" limit as required by ADA. This is also true of some wall-mounted electronic cabinets (E110) and cubbies (Lobby C120).

b. Handrails at Corridor Stairs / Ramps:

Handrails at both stairs and ramps lack the required extension and top & bottom landings as required by IBC 1010.1.5. Where not continuous, between flights, the handrails should extend horizontally for the width of one tread. Condition occurs at Corridor E112, Stairs and ramps, Lobby A112, Stair G218, and Stair G137.

RECOMMENDATIONS

- At display cases, add bases from the case bottom to the floor. At other wall mounted protrusions, create physical barriers below projections.
- Modify existing hand railing to comply with IBC 1010.1 at top, intermediate and bottom landings.



Corridor D117
Display cases protrude beyond ADA limits



Lobby C120
Cubbies protrude beyond ADA limits

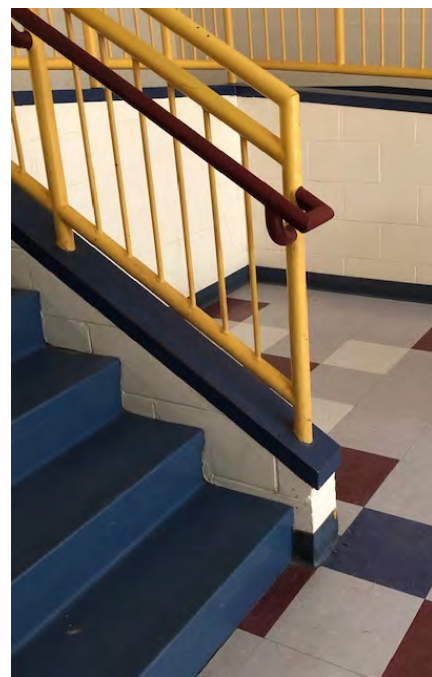

Corridor E112
Handrails lack required extensions

SCOPE OF WORK

See recommendations above.

Infill: Abandoned Exterior Wall Openings

RELATED SCOPES OF WORK
Not Applicable

EM-ALL-BE-3010				
Priority	Cost			
	\$			
Coordination by Discipline				
<input checked="" type="checkbox"/>	<input checked="" type="checkbox"/>	<input type="checkbox"/>	<input type="checkbox"/>	<input type="checkbox"/>
A	M	E	P	FP
<input checked="" type="checkbox"/>	<input type="checkbox"/>	<input type="checkbox"/>	<input checked="" type="checkbox"/>	<input type="checkbox"/>
S	LS	SC	BE	C

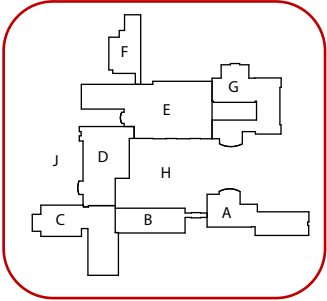

EXISTING CONDITIONS

- a. Abandoned Louvers
- b. Plywood infill

RECOMMENDATIONS

Infill abandoned exterior wall openings and louvers.
Infill plywood-filled openings where louvers have previously been removed.

NEXT STEPS

In rooms where Unit Ventilators have been replaced with ducted air systems, infill abandoned unit ventilator louvers.

SCOPE OF WORK

To be assessed at time of work.



Roof Improvements and Repairs

RELATED SCOPES OF WORK

Not Applicable

EM-ALL-BE-3011				
Priority	Cost			
	TBD			
Coordination by Discipline				
<input checked="" type="checkbox"/>	<input checked="" type="checkbox"/>	<input type="checkbox"/>	<input checked="" type="checkbox"/>	<input type="checkbox"/>
A	M	E	P	FP
<input checked="" type="checkbox"/>	<input type="checkbox"/>	<input type="checkbox"/>	<input checked="" type="checkbox"/>	<input type="checkbox"/>
S	LS	SC	BE	C

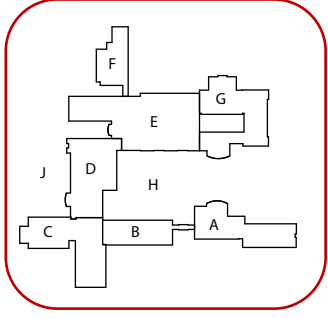

EXISTING CONDITIONS

- Overall Roof Membrane Condition: Significant patching and evidence of ponding exists throughout. Majority of the roof areas are approaching their end of life. See Harriman report of 2012 for detailed discussion of roof items. Conditions outlined appear to be largely unchanged.
- Penetrations and Drains: Building Wing B, Roof drain requires a cage. See Plumbing items.
- Roof Hatches and curb: These appear to be un-insulated and contribute to thermal bridging. Roof hatches are not currently OSHA compliant for fall protection.
- Access Ladders: Access ladders are not currently OSHA compliant for fall protection.
- Insulation: Harriman report of 2012 indicates several areas are covered with two layers of insulation, mechanically fastened. Type of insulation and R-Value are not known.

See plan diagram on following page reflecting roof age and insulation.

RECOMMENDATIONS

- Make improvements as noted in Harriman report of 2012 and areas where roof is now or soon approaching end of life. Also consider places where large mechanical units are being replaced, removed or relocated, or where roofing membrane was installed incorrectly.
- Remedy issues at penetrations and drains per referenced work item recommendations.
- Install insulated roof hatch assemblies w/ appropriate fall protection.
- The design team recommends that guard rails and stairs are provided to conform with OSHA requirements. Also see related mechanical items referenced above.

NEXT LEVEL

Where possible, installation of additional insulation is recommended to improve building performance and reduce the heating and cooling load. Good practice would be to bring roof insulation into minimum compliance with pending adoption of IECC 2015: R-30ci above deck OR R-19 above deck with R-11LS below deck. This would need to be reviewed by an engineering team to review the impact of additional load capacity on existing structure due to increased snow load and would require coordination with mechanical systems to ensure their performance is accounting for the change in heat/cooling load.

SCOPE OF WORK

- Install galvanized guard rails and stairs in conformance with OSHA requirements.
- Replace non-conforming existing access ladders.
- Install insulated roof hatch, min. size required by AHJ. Provide fall protection meeting OSHA requirements.
- Replace EPDM roof surface in areas where membrane is at the end of life, particularly in places where large mechanical units are being replaced, removed or relocated, or where roofing membrane was installed incorrectly. Assess condition of assembly below and either re-surface or replace entire assembly as needed.
- Where replacement of entire roof assembly is being considered, provide insulation in compliance with current IECC code requirements at time of replacement. Architect to provide recommendation for replacement assemblies.

Notes on Costing: Given that the scope of this work may vary greatly, please see costing sheet and associated back-up for relevant unit pricing and allowances.

Cape Elizabeth Schools Needs Assessment



Pond Cove and Middle School Roof Diagrams

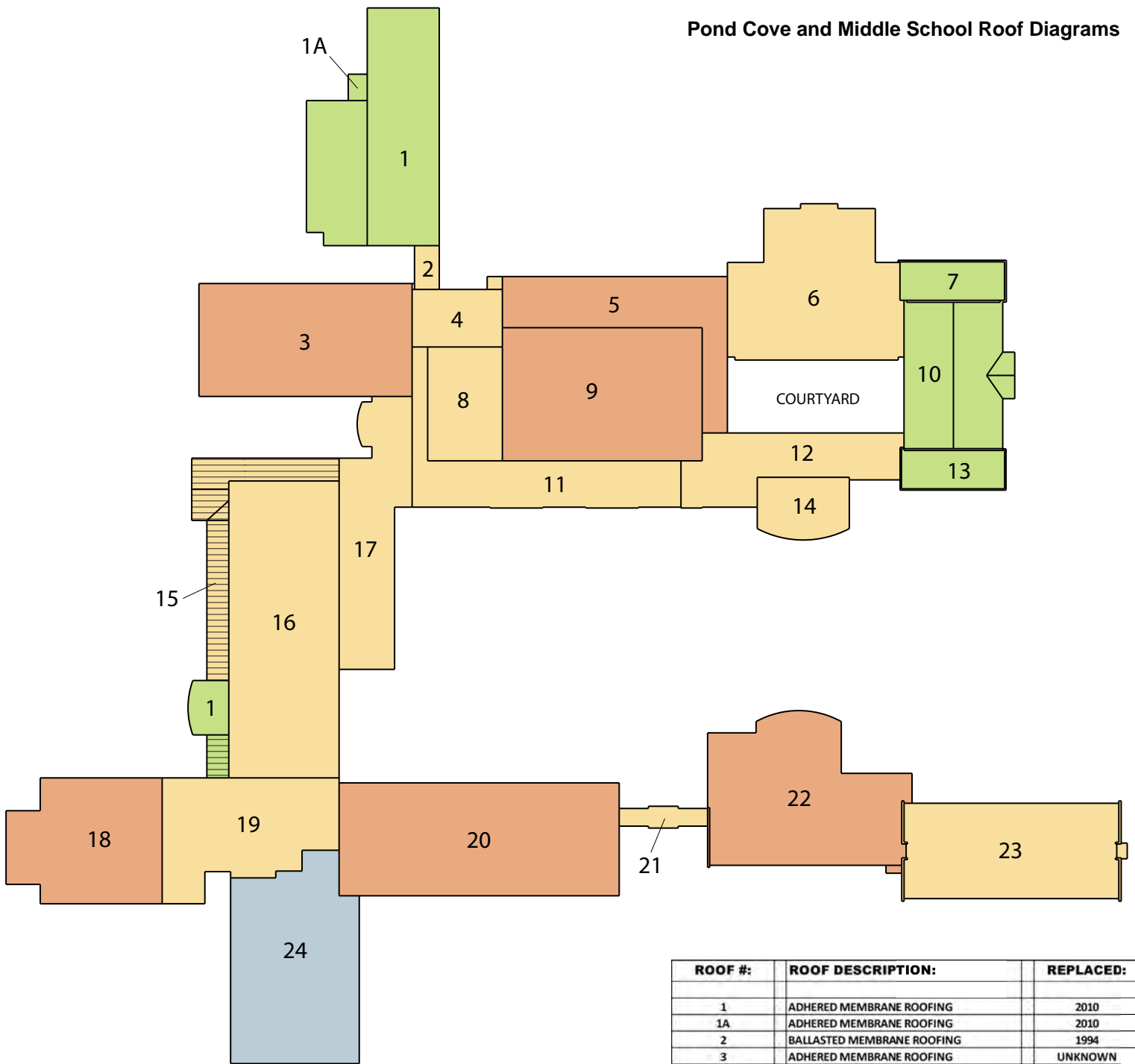

ROOF HATCH KEY

- ROOF IS A HIGH PRIORITY FOR REPLACEMENT
- ROOF REPLACED IN 1994 - NEAR END OF LIFE
- ROOF REPLACED IN 2004
- ROOF CONDITION IS UNCERTAIN
- INDICATES ROOF TYPE HAS A 33 YR LIFESPAN

ROOF #:	ROOF DESCRIPTION:	REPLACED:
1	ADHERED MEMBRANE ROOFING	2010
1A	ADHERED MEMBRANE ROOFING	2010
2	BALLASTED MEMBRANE ROOFING	1994
3	ADHERED MEMBRANE ROOFING	UNKNOWN
4	BALLASTED MEMBRANE ROOFING	1994
5	ADHERED MEMBRANE ROOFING	UNKNOWN
5A	ADHERED MEMBRANE ROOFING	UNKNOWN
6	BALLASTED MEMBRANE ROOFING	1994
7	ADHERED MEMBRANE ROOFING	UNKNOWN
8	BALLASTED MEMBRANE ROOFING	1994
9	ADHERED MEMBRANE ROOFING	UNKNOWN
10	SHINGLED ROOF	UNKNOWN
11	BALLASTED MEMBRANE ROOFING	1994
12	BALLASTED MEMBRANE ROOFING	1994
13	ADHERED MEMBRANE ROOFING	UNKNOWN
14	BALLASTED MEMBRANE ROOFING	1994
15	STANDING SEAM METAL ROOFING	1994
16	BALLASTED MEMBRANE ROOFING	1994
17	BALLASTED MEMBRANE ROOFING	1994
18	ADHERED MEMBRANE ROOFING	UNKNOWN
19	BALLASTED MEMBRANE ROOFING	1994
20	ADHERED MEMBRANE ROOFING	UNKNOWN
21	ADHERED MEMBRANE ROOFING	1994
22	ADHERED MEMBRANE ROOFING	UNKNOWN
23	ADHERED MEMBRANE ROOFING	1994
24	ADHERED MEMBRANE ROOFING	2004

Skylight Replacement

EM-ROOF-BE-3012				
Priority	Cost			
	\$\$\$\$			
Coordination by Discipline				
<input checked="" type="checkbox"/>	<input type="checkbox"/>	<input type="checkbox"/>	<input type="checkbox"/>	<input type="checkbox"/>
A	M	E	P	FP
<input checked="" type="checkbox"/>	<input type="checkbox"/>	<input type="checkbox"/>	<input checked="" type="checkbox"/>	<input type="checkbox"/>
S	LS	SC	BE	C

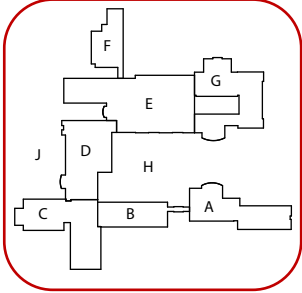

RELATED SCOPES OF WORK

Not Applicable

EXISTING CONDITIONS

Most of the roof skylights are showing signs of age, including peeling paint, gasket and/or seal issues, and evidence of corrective action to stop leaks. In some locations, EPDM flashing tape was used to stop leakage. This is not a manufacturer-approved correction and may be detrimental to the life of the skylight panels. The skylights are 25 years-old and have reached the end of their useful life.

RECOMMENDATIONS

At a minimum, a skylight glazing company should be contracted to:

- Clean, patch and paint frames with flaking paint.
- Dismantle the frame and panel and apply new seals between the frame and panels.

NEXT LEVEL

While some corrective action on the skylight units may provide some interim relief against leaks, the design team recommends the skylights be replaced with new units. They are showing significant signs of deterioration and corrective repairs are not likely to significantly extend their useful life.

SCOPE OF WORK

Remove existing skylight frames to roof curb. Provide new curb flashing and new skylights and glazing. Skylights include:

- (4) 8' x 8' pyramid skylights
- (3) 6' x 6' pyramid skylights
- (2) 15'-8" x 15'-8" gable skylights with ends



8' x 8' pyramid skylight



EPDM flashing tape and sealant to stop leakage

Site Issues

EM-EXT-C-3014				
Priority	Cost			
	\$\$\$\$			
Coordination by Discipline				
<input checked="" type="checkbox"/>	<input type="checkbox"/>	<input checked="" type="checkbox"/>	<input type="checkbox"/>	<input type="checkbox"/>
A	M	E	P	FP
<input type="checkbox"/>	<input type="checkbox"/>	<input checked="" type="checkbox"/>	<input type="checkbox"/>	<input checked="" type="checkbox"/>
S	LS	SC	BE	C

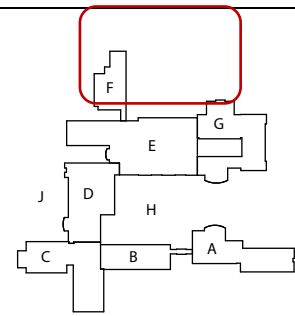

RELATED SCOPES OF WORK

Not Applicable

EXISTING CONDITIONS

- Primary building entries at both Middle School and Pond Cove lack vehicle barriers to prevent cars or trucks being driven into the school.
- Verify vegetation such as shrubbery at building entries is 20 feet from entry doors.
- Middle School baseball field and playground do not have fencing. Play areas are open to adjacent public drive and town street.
- Pad mounted transformer north of Building F is adjacent to a traffic lane and lacks protection from backing vehicles.
- Pathways between Middle School / Pond Cove to the lower ball field and tennis courts include sets of exterior steps. Handicapped access is possible, but is excessively long and indirect. Classes with HC students move as a single group and the HC route is long and time consuming.
- Update / replace site signage. Existing building mounted site signage such as "No Parking, Fire Lane" have faded and peeled.
- On school assembly events with parents, parking can exceed lot capacity. As a result, cars are parked on the medians, road shoulders and in the drive aisles.

RECOMMENDATIONS

- Place discrete physical barriers such as concrete filled steel bollards or large granite blocks at building entry points to protect from vehicles and outlined in Safety and Security Guidelines, Maine Department of Education. Standards.
- If necessary, clear perennial bushes from building entry points.
- Add fencing to define student outdoor spaces and public spaces.
- Add concrete filled steel bollard to protect transformer from vehicles.
- Provide a more direct accessible route between the MS/PC and the lower ball fields and tennis courts.
- Replace and evaluate exterior signage for Fire Lanes and No Parking areas.
- If deemed necessary, an additional row of parking could be added to the service drive north of building F. This parking would best be dedicated to staff or faculty.

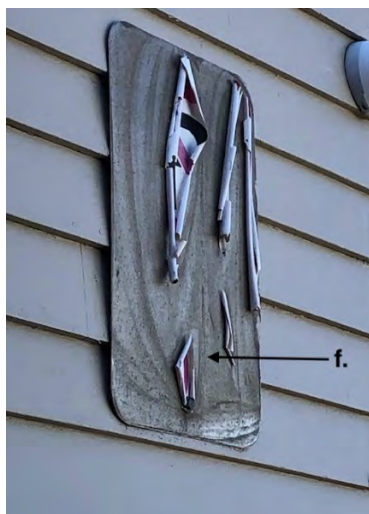

Exterior Middle School Site Work

- Fields lack fencing
- Transformer needs protective bollards
- Exterior signage for fire lanes and no parking zones need replacement
- Possible parking expansion

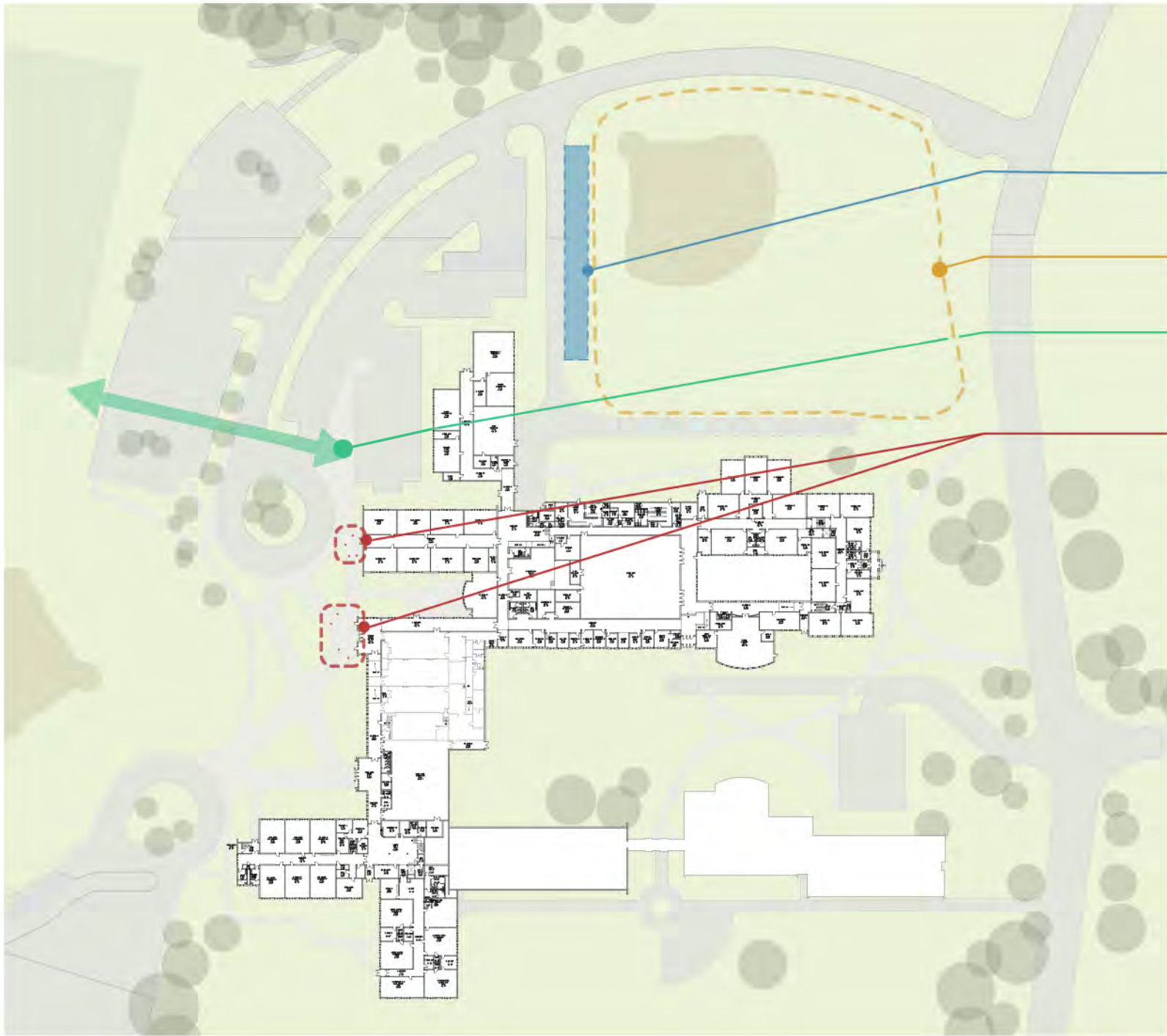

g additional parking

c fencing

e ADA accessibility to lower ball fields

a bollards at entry

Upgrade public address phone system to VOIP with paging

RELATED SCOPES OF WORK

Not Applicable

EM-ALL-E-3015	
Priority	Cost
	\$
Coordination by Discipline	
<input checked="" type="checkbox"/>	<input type="checkbox"/>
<input checked="" type="checkbox"/>	<input type="checkbox"/>
A	M E P FP
<input type="checkbox"/>	<input type="checkbox"/>
<input type="checkbox"/>	<input type="checkbox"/>
S	LS SC BE C

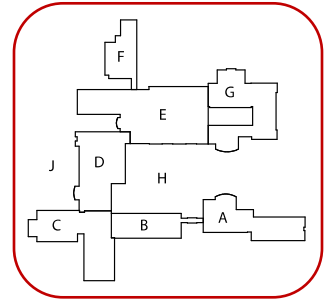

EXISTING CONDITIONS

The existing phone system is an analog system, that is outdated, and not all locations have handsets. The intelligibility of the paging system is low, and the system is aging.



RECOMMENDATIONS

It is recommended that the existing phone system and paging be removed, and replaced with a Voice of IP phone system that includes paging, and intercom. The existing system uses older technology. With an upgraded system, multiple systems can be combined into one system. The paging, the phone, and the intercom can use one system to perform multiple functions. In addition, the new technology has better intelligibility, and features not available with the traditional analog phone system.

SCOPE OF WORK

Removal of telephone wiring to phone handsets throughout the facility. Removal of intercom/paging speakers and wiring. Installation of new CAT6 wiring, headsets, and master consoles in office.

Upgrade classroom lighting to LED with vacancy sensors

RELATED SCOPES OF WORK
E-ALL-A-3000

EM-ALL-E-3016				
Priority	Cost			
	\$\$\$			
Coordination by Discipline				
<input checked="" type="checkbox"/>	<input type="checkbox"/>	<input checked="" type="checkbox"/>	<input type="checkbox"/>	<input type="checkbox"/>
A	M	E	P	FP
<input type="checkbox"/>	<input type="checkbox"/>	<input type="checkbox"/>	<input type="checkbox"/>	<input type="checkbox"/>
S	LS	SC	BE	C

EXISTING CONDITIONS

The classrooms typically have 2x4 recessed fluorescent fixtures with three or four lamps. Controls consist of a combination of one level, two level and three level switching with local switches. The multiple level of lighting provides for reduced energy consumption. Lighting levels appear to be adequate. Occupancy sensors were not present, and no form of automatic off for classroom lighting is present.



RECOMMENDATIONS

It is recommended that existing fluorescent fixtures be replaced with higher efficient LED fixtures with automatic off lighting controls. LED fixtures can provide the same amount of light, with lower power consumption. In addition, fixtures with automatic controls and dimming capability with provide further energy savings. Lighting load account for a large portion of the energy usage in most facilities, and can reduce operating costs. In addition, LED fixtures do not require the replacement of lamps that the fluorescent fixtures require, providing further savings in maintenance.

SCOPE OF WORK

Remove existing lighting in classrooms, and the media center. Provide LED direct/indirect fixtures with manual on/automatic off occupancy sensors, and dimming controls.

Upgrade corridor lighting to LED with time clock.

RELATED SCOPES OF WORK

Not Applicable

EM-ALL-E-3017				
Priority	Cost			
	\$\$\$			
Coordination by Discipline				
<input checked="" type="checkbox"/>	<input type="checkbox"/>	<input checked="" type="checkbox"/>	<input type="checkbox"/>	<input type="checkbox"/>
A	M	E	P	FP
<input type="checkbox"/>	<input type="checkbox"/>	<input type="checkbox"/>	<input type="checkbox"/>	<input type="checkbox"/>
S	LS	SC	BE	C

The diagram shows a floor plan of a building with a central corridor. Rooms are labeled A through J. Room E is located in the upper right quadrant and is enclosed in a red rounded rectangle. Other rooms are distributed around the central corridor.

EXISTING CONDITIONS

The existing are older style, and consists of a combination of 2'x2' and 2'x4' recessed fluorescent T8 fixtures. Controls consist of a combination of local keyed switches. Lighting levels appear to be adequate. Occupancy sensors were not present, and no form of automatic off for corridor lighting was noted.

RECOMMENDATIONS

It is recommended that existing fluorescent fixtures be replaced with higher efficient LED fixtures with programmable time clock to provide for automatic off. LED fixtures can provide the same amount of light, with lower power consumption. In addition, fixtures with automatic controls and dimming capability with provide further energy savings. Lighting load account for a large portion of the energy usage in most facilities, and can reduce operating costs. In addition, LED fixtures do not require the replacement of lamps that the fluorescent fixtures require, providing further savings in maintenance.

SCOPE OF WORK

Remove existing lighting in corridors. Provide LED direct/indirect fixtures. Provide programmable time clock and connection to corridor lighting. Provide programming and training for owner on operation.

Upgrade gymnasium lighting to LED with vacancy sensors

RELATED SCOPES OF WORK
Not Applicable

EM-E141-E-3018				
Priority	Cost			
	\$\$			
Coordination by Discipline				
<input type="checkbox"/>	<input type="checkbox"/>	<input checked="" type="checkbox"/>	<input type="checkbox"/>	<input type="checkbox"/>
A	M	E	P	FP
<input type="checkbox"/>	<input type="checkbox"/>	<input type="checkbox"/>	<input type="checkbox"/>	<input type="checkbox"/>
S	LS	SC	BE	C

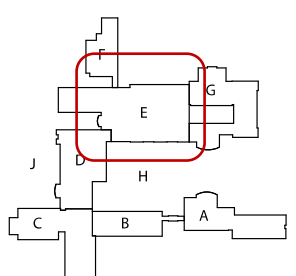

EXISTING CONDITIONS

The existing lighting in the gymnasium is T5 lighting, with local controls.



RECOMMENDATIONS

It is recommended the lighting be upgraded to high bay, energy efficient LED lighting, with occupancy sensors. LED fixtures can provide the same amount of light, with lower power consumption. In addition, fixtures with automatic controls and dimming capability with provide further energy savings. Lighting load account for a large portion of the energy usage in most facilities, and can reduce operating costs. In addition, LED fixtures do not require the replacement of lamps that the fluorescent fixtures require, providing further savings in maintenance. This is particularly important in areas such as gymnasiums which have high ceilings, and makes lamp replacement more difficult.

SCOPE OF WORK

Remove existing light fixtures and controls. Provide LED, high bay light fixtures with cages and manual on/automatic off occupancy sensors for the gymnasium.

Upgrade emergency lighting

RELATED SCOPES OF WORK

EM-ALL-LS-3026

EM-G-LS-3053

EM-ALL-E-3019				
Priority	Cost			
	\$			
Coordination by Discipline				
<input type="checkbox"/>	<input type="checkbox"/>	<input checked="" type="checkbox"/>	<input type="checkbox"/>	<input type="checkbox"/>
A	M	E	P	FP
<input type="checkbox"/>	<input checked="" type="checkbox"/>	<input type="checkbox"/>	<input type="checkbox"/>	<input type="checkbox"/>
S	LS	SC	BE	C

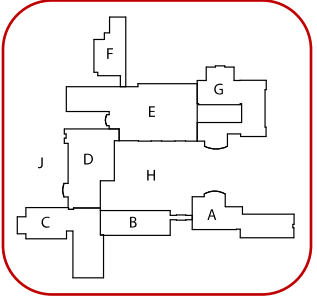

EXISTING CONDITIONS

The existing emergency lighting are older style, and consist of a combination of self contained battery units, remote dual and single heads. The single heads do not meet current code for egress lighting. It does not appear that there is adequate coverage, to meet the 1 fc requirement from NFPA 101, and not all exit doors have an exterior egress emergency light. In a number of instances, the fixtures appear to be damaged.

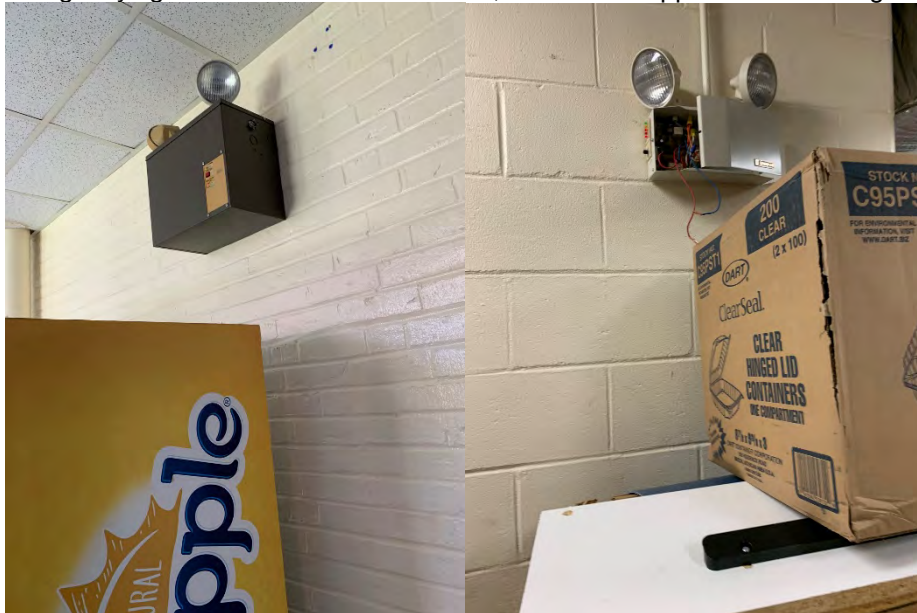

RECOMMENDATIONS

It is recommended that the emergency egress lighting be replaced.

SCOPE OF WORK

Remove existing emergency lighting, provide emergency egress lighting to meet NFPA requirements. Provide LED, dual head fixtures with battery backup in corridors and along egress paths, and exterior emergency LED fixtures at egress doors.

Provide metering for building

RELATED SCOPES OF WORK

Not Applicable

EM-F103-E-3020	
Priority	Cost
	\$
Coordination by Discipline	
<input type="checkbox"/>	<input type="checkbox"/> <input checked="" type="checkbox"/> <input type="checkbox"/> <input type="checkbox"/>
A	M E P FP
<input type="checkbox"/>	<input type="checkbox"/> <input type="checkbox"/> <input type="checkbox"/>
S	LS SC BE C

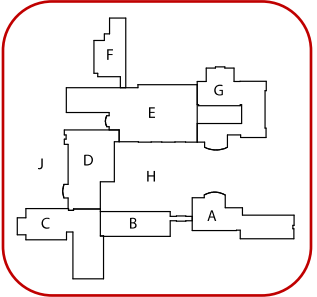

EXISTING CONDITIONS

The existing electrical demand on the buildings is unknown.

RECOMMENDATIONS

In order to determine the electrical usage of the buildings, and demand on the equipment, it is recommended an electrical meter be placed on the service entrance to determine the usage. This information can be used to accurately size replacement equipment for the facility.

SCOPE OF WORK

Place a smart meter on the service entrance that measures electrical usage, including peak demand for a 30-day period. The meter is to be used for evaluation of usage, but will remain for future use to have the ability to monitor electrical usage.

Provide vacancy/occupancy sensors

RELATED SCOPES OF WORK
EM-ALL-M-3027

EM-ALL-E-3021				
Priority	Cost			
	\$\$			
Coordination by Discipline				
<input type="checkbox"/>	<input checked="" type="checkbox"/>	<input checked="" type="checkbox"/>	<input type="checkbox"/>	<input type="checkbox"/>
A	M	E	P	FP
<input type="checkbox"/>	<input type="checkbox"/>	<input type="checkbox"/>	<input type="checkbox"/>	<input type="checkbox"/>
S	LS	SC	BE	C

EXISTING CONDITIONS

Most of the building is not equipped with occupancy or vacancy sensors. Lighting is controlled mostly by manual, local switches. Classrooms, function spaces, and offices do not have any controls to provide energy savings.

RECOMMENDATIONS

It is recommended that manual on, automatic off controls be provided in the classrooms, offices and common spaces.

SCOPE OF WORK

Provide dual technology, ceiling mounted, programmable, manual on/automatic off occupancy sensors in classrooms, offices, restrooms. Provide automatic coverage, and commissioning of controls.

Provide DMX compatible stage lighting

RELATED SCOPES OF WORK

Not Applicable

EM-ALL-E-3022				
Priority	Cost			
	\$\$			
Coordination by Discipline				
<input type="checkbox"/>	<input type="checkbox"/>	<input checked="" type="checkbox"/>	<input type="checkbox"/>	<input type="checkbox"/>
A	M	E	P	FP
<input type="checkbox"/>	<input type="checkbox"/>	<input type="checkbox"/>	<input type="checkbox"/>	<input type="checkbox"/>
S	LS	SC	BE	C

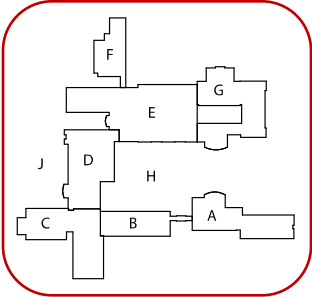

EXISTING CONDITIONS

The existing lighting in the cafetorium consists of T5 high bay fixtures, stage lights and wall mounted fixtures. Lighting levels appear to be low, and no occupancy sensors were noted.

RECOMMENDATIONS

It is recommended that the stage lighting be upgraded to DMX compatible lighting. This control will enable the fixtures to be independently controlled and provide advanced theatrical controls.

SCOPE OF WORK

Remove existing stage lighting and controls. Provide DMX compatible lighting, and controls.

Provide dedicated circuits for charging station

RELATED SCOPES OF WORK

Not Applicable

EM-ALL-E-3023				
Priority	Cost			
	\$\$			
Coordination by Discipline				
<input type="checkbox"/>	<input type="checkbox"/>	<input checked="" type="checkbox"/>	<input type="checkbox"/>	<input type="checkbox"/>
A	M	E	P	FP
<input type="checkbox"/>	<input type="checkbox"/>	<input type="checkbox"/>	<input type="checkbox"/>	<input type="checkbox"/>
S	LS	SC	BE	C

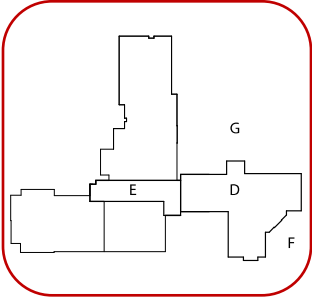

EXISTING CONDITIONS

The existing classrooms have limited receptacles and limited circuits for each classroom.

RECOMMENDATIONS

It is recommended with the addition of technology in the classrooms, that each classroom be provided with a dedicated quad receptacle, with a dedicated circuit for purposes of charging laptops/tablets.

SCOPE OF WORK

Provide on quad on a dedicated circuit per classroom.

Replace overhead projectors with Smartboards

RELATED SCOPES OF WORK
Not Applicable

EM-ALL-E-3024				
Priority	Cost			
	\$\$			
Coordination by Discipline				
<input checked="" type="checkbox"/>	<input type="checkbox"/>	<input checked="" type="checkbox"/>	<input type="checkbox"/>	<input type="checkbox"/>
A	M	E	P	FP
<input type="checkbox"/>	<input type="checkbox"/>	<input type="checkbox"/>	<input type="checkbox"/>	<input type="checkbox"/>
S	LS	SC	BE	C

The diagram shows a floor plan of a classroom building with rooms labeled A through J. Room E is highlighted with a red border, indicating the focus of the project. The layout includes a central hallway and several classrooms branching off.

EXISTING CONDITIONS

The existing classrooms are typically equipped with overhead projectors.

RECOMMENDATIONS

As technology advances, it is recommended that classrooms be provided with smart boards to keep up with technology.

SCOPE OF WORK

Remove existing overhead projector. Provide Smart board, and CAT6 connections on teaching wall of classrooms.

Provide AI phones with video at entrances

RELATED SCOPES OF WORK

Not Applicable

EM-ALL-E-3025	
Priority	Cost
	\$
Coordination by Discipline	
<input checked="" type="checkbox"/>	<input type="checkbox"/>
<input checked="" type="checkbox"/>	<input type="checkbox"/>
<input type="checkbox"/>	<input type="checkbox"/>
A	M E P FP
<input type="checkbox"/>	<input type="checkbox"/>
<input type="checkbox"/>	<input type="checkbox"/>
S	LS SC BE C

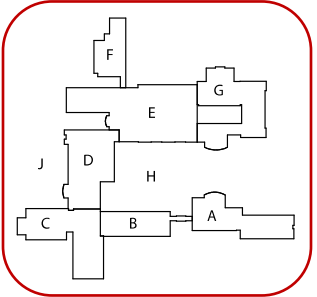

EXISTING CONDITIONS

The existing entrance doors do not have any communication for visitors.

RECOMMENDATIONS

It is recommended for safety reasons, to provide an AI phone at the entrance door for visual and audio communication from the front office to the entrance. This will provide a buzzer for the visitor to call the office and an intercom to communicate with staff. It is recommended that a remote door operator be provided with the ability of the office to open the door to allow entry.

SCOPE OF WORK

Provide a complete system, with AI phone at the entrance, with console located in the office, with audio, video, and remote door operation.

Exterior Doors

EM-ALL-LS-3026				
Priority	Cost			
	\$\$			
Coordination by Discipline				
<input checked="" type="checkbox"/>	<input type="checkbox"/>	<input checked="" type="checkbox"/>	<input type="checkbox"/>	<input type="checkbox"/>
A	M	E	P	FP
<input checked="" type="checkbox"/>	<input checked="" type="checkbox"/>	<input checked="" type="checkbox"/>	<input checked="" type="checkbox"/>	<input checked="" type="checkbox"/>
S	LS	SC	BE	C

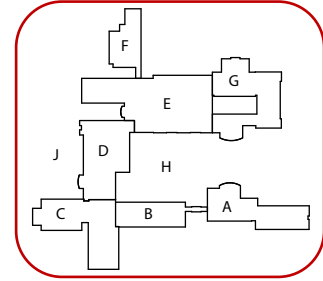

RELATED SCOPES OF WORK

EM-ALL-LS-3027

EXISTING CONDITIONS

- Exterior pavement or step should be flush with the interior floor level per IBC 1010.1.5 requiring floor or landing to be at the same elevation on each side of the door.
- Maintain clear exiting access to the "Public Way"
- Exterior doors should be numbered in large, permanent, weatherproof 10" to 12" high numbers at exterior doors. Numbers should be sequentially placed in a counter-clockwise pattern per MDE security standards. While numbered current system does not meet the state standard in height and consistency.
- Exterior exit doors require both exterior light fixture (1 foot-candle at walking surface) and emergency lighting per IBC 1006.3 for a duration of 90 minutes.
- At some locations, vehicles parking adjacent to the door may block the door swing and prevent exiting.

RECOMMENDATIONS

- Adjust pavement to meet IBC standards. Maintain 1/2" difference with a positive slope of 1/4" per foot away from threshold for drainage control.
- Extend bituminous paving to from designated exit doors to public ways.
- Standardize exterior door signage to conform with MDE standards.
- Where lacking, install exterior wall pack light fixture with emergency power capacity. A single wall mounted fixture can meet both requirements.
- Install vehicular bollards to ensure that doors are able to fully open.

Notes on Costing: Associated site work has been anticipated in costing back-up.

SCOPE OF WORK

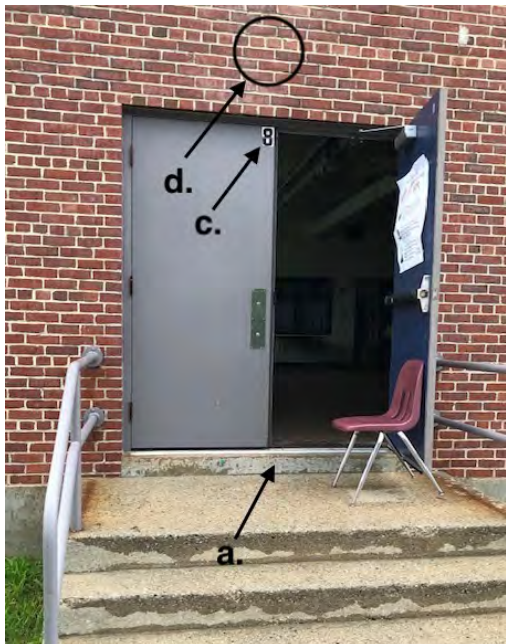

Door Number	Pavement / Step level	Public way access	Ext. door numbering	Exterior lighting	Exterior emergency lighting	Install bollards
#1	--	--	c.	--	--	--
#2	--	--	c.	--	--	--
#3	--	--	c.	d.	d.	--
#4	--	--	c.	d.	d.	--
#5	--	--	c.	--	--	--
#6	--	--	c.	d.	d.	--
#7	--	--	c.	--	--	--
#8	a.	--	c.	d.	d.	--
#9	a.	--	c.	--	--	e.
#10	--	--	c.	d.	d.	--
#11	--	--	c.	--	--	--
#12	NA	NA	NA	NA	NA	NA
#13	--	--	c.	--	--	--
#14	--	--	c.	--	--	--
#15	--	--	c.	d.	d.	--
#16	--	--	c.	d.	d.	--
#17	--	--	c.	--	d.	--
#18	--	b.	c.	d.	d.	--
#19	--	--	c.	d.	d.	--
#20	a.	b.	c.	d.	d.	--
#21	--	--	c.	d.	d.	--
#22	--	b.	c.	d.	d.	--
#23	--	b.	c.	d.	d.	--
#24	--	--	c.	d.	d.	--

Cape Elizabeth Schools Needs Assessment

Exterior Door #8

Lacks same elevation on each side of door (a.)

Lacks exterior standard & emergency lighting (d.)

Lacks adequately sized door numbering. (c.)

SCOPE OF WORK, continued

Door Number	Pavement / Step level	Public way access	Ext. door numbering	Exterior lighting	Exterior emergency lighting	Install bollards
#25	--	--	c.	d.	d.	--
#26	--	--	c.	d.	d.	--
#27	--	--	c.	--	--	--
#28	--	--	c.	d.	d.	--
#29	--	--	c.	--	d.	--

Life Safety: Room Signage

RELATED SCOPES OF WORK

- EM-ALL-A-3003
- EM-ALL-LS-3026

EM-ALL-LS-3027				
Priority	Cost			
	\$\$			
Coordination by Discipline				
<input checked="" type="checkbox"/>	<input type="checkbox"/>	<input type="checkbox"/>	<input type="checkbox"/>	<input type="checkbox"/>
A	M	E	P	FP
<input type="checkbox"/>	<input checked="" type="checkbox"/>	<input type="checkbox"/>	<input type="checkbox"/>	<input type="checkbox"/>
S	LS	SC	BE	C

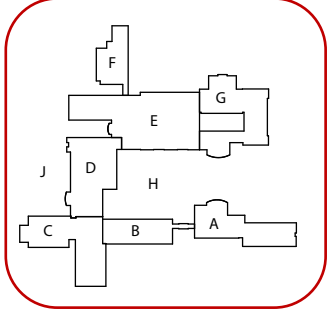

EXISTING CONDITIONS

- Room signage is non-standardized throughout the facility: Some rooms have signage; some rooms are unidentified or have temporary signage at the corridor. Many classrooms have temporary signage at exterior windows.
- The C214 Elevator Lobby lacks compliant life safety signage.
- Exterior doors do not have consistent identifying signage on both the interior and exterior.

RECOMMENDATIONS

- Interior Signage:** the design team recommends installing unified, permanent, ANSI compliant identifying signage on all doors facing the corridor, and primary entry doors along egress paths of travel. Rooms should be identified by name and number. See item EM-ALL-A-3003 for additional notes on doors.
- Exterior Signage:** doors should be updated to have consistent ANSI compliant identifying signage on both the exterior and interior of the door. See item EM-ALL-LS-3026.
- Exterior Signage at windows should be consistent for all spaces.
- All doors and exterior windows: Signage should correspond to registered Life Safety documents on file with AHJ. The design team recommends these documents be updated if necessary.
- Unisex restroom signage throughout should be updated to comply with requirements for gender neutral signage.

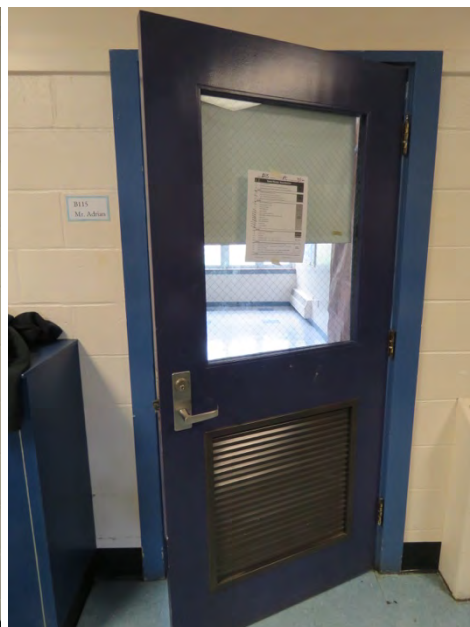
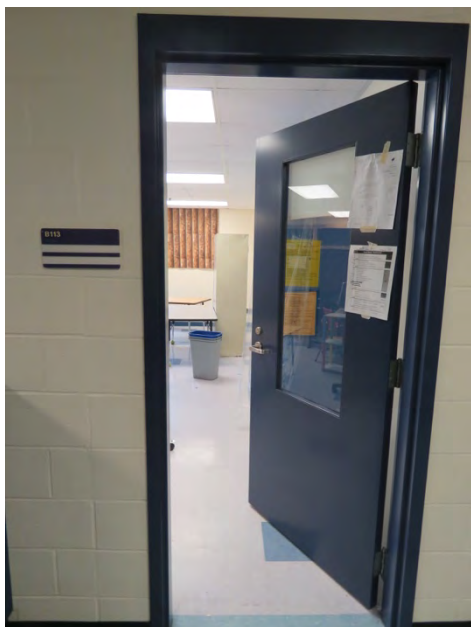

Cape Elizabeth Schools Needs Assessment

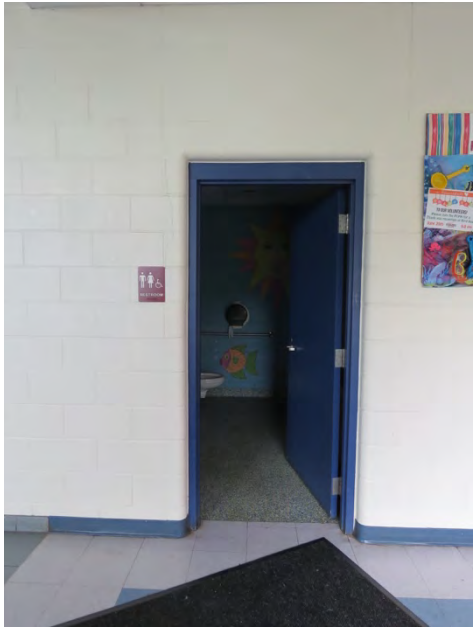

Provide Burglar Bars at Low Louvers

To meet the Maine DoE requirements
Provide in louvers less than 8 ft high

RELATED SCOPES OF WORK

EM-NEW-SC-3051

EM-ALL-SC-3028				
Priority	Cost			
	\$			
Coordination by Discipline				
<input checked="" type="checkbox"/>	<input checked="" type="checkbox"/>	<input type="checkbox"/>	<input type="checkbox"/>	<input type="checkbox"/>
A	M	E	P	FP
<input type="checkbox"/>	<input type="checkbox"/>	<input checked="" type="checkbox"/>	<input type="checkbox"/>	<input type="checkbox"/>
S	LS	SC	BE	C

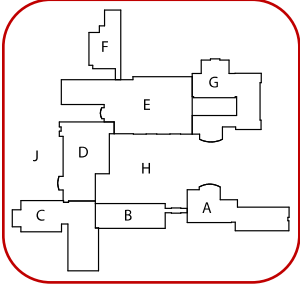

EXISTING CONDITIONS

Some louvers and other outside wall openings are lower than 8 feet above the adjacent grade, and large enough and unobstructed enough for a person to enter. In most cases it would be impractical to relocate the openings.

RECOMMENDATIONS

To meet the intent of the Maine Department of Education's Public School Standards & Guidelines for New School Construction & Major Renovation Projects, provide burglar bars in low openings to prevent entry.

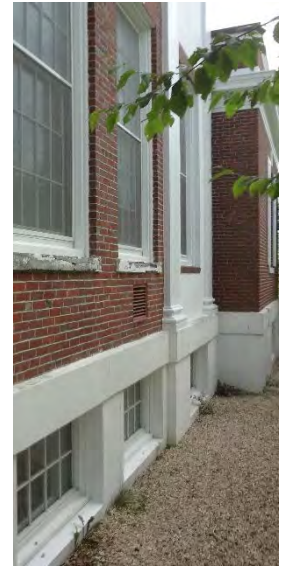

SCOPE OF WORK

Remove ducts from the interior of the wall openings as required. Install burglar bars in the outside wall openings. Reattach ducts.

Energy Recovery for Units with Outdoor Air

Energy use and system capacities can be reduced by recovering exhaust heat

RELATED SCOPE OF WORK

Not Applicable

EM-ALL-M-3029				
Priority	Cost			
	\$\$\$\$			
Coordination by Discipline				
<input checked="" type="checkbox"/>	<input checked="" type="checkbox"/>	<input checked="" type="checkbox"/>	<input type="checkbox"/>	<input type="checkbox"/>
A	M	E	P	FP
<input checked="" type="checkbox"/>	<input type="checkbox"/>	<input type="checkbox"/>	<input type="checkbox"/>	<input type="checkbox"/>
S	LS	SC	BE	C

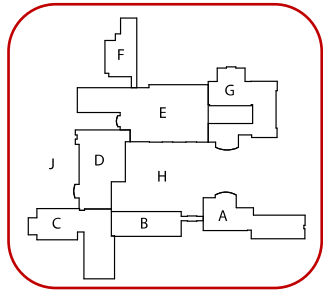

EXISTING CONDITIONS

There are several roof-mounted 100%-outside-air heat-recovery units (HRUs) with built-in heat recovery to transfer sensible (dry) heat from exhaust air to incoming ventilation air; these are old and in need of replacement as discussed in a related work item. There are also various ages of indoor air handling units (AHUs) and gas-fired rooftop units (RTUs) which provide mixed air at less than 100% outside air; these do not have any recovery.



RECOMMENDATIONS

The Maine Department of Education Public School Standards and Guidelines for New School Construction & Major Renovation Projects requires energy recovery for air handling systems which provide outdoor air for ventilation. As units are replaced, their replacement units should have energy recovery per the State Energy Code and the applicable edition of the ASHRAE 90.1 energy standard. Energy recovery transfers latent (wet) heat energy and sensible (dry) heat energy from exhaust to incoming air; heat recovery only transfers sensible heat energy. The latent recovery is helpful in most, but not all, applications.

NEXT LEVEL

Retrofit existing air handling systems that are not due for replacement, to provide energy recovery. For example, an existing gas-fired RTU serving a locker room can have an energy-recovery ventilator (ERV) mounted alongside to supply and exhaust the minimum constant ventilation air; in economizer mode the additional outside air would bypass the ERV.

SCOPE OF WORK

1. Base Level: As air handling systems are replaced under other work items, and when replacing them on an as-needed basis, incorporate energy recovery into any replacement air handling system that provides outdoor air for ventilation. Provide additional ductwork, roof and wall openings, space for equipment, structural support, fan power, and electrical power as required. Provide control of the energy recovery, including economizer bypass to reduce or disable the recovery based on room needs as required by the Energy Code. Insulate outside air intake ducts, and indoor exhaust ducts from the energy recovery device to outdoors.
2. Next Level: Retrofit existing air handling systems to add energy recovery.

Provide MERV 13 or MERV 11 filters

Provide MERV 13 or MERV 11 filters on HVAC equipment throughout.

RELATED SCOPES OF WORK

Not Applicable

EM-ALL-M-3031				
Priority	Cost			
	\$			
Coordination by Discipline				
<input type="checkbox"/>	<input checked="" type="checkbox"/>	<input type="checkbox"/>	<input type="checkbox"/>	<input type="checkbox"/>
A	M	E	P	FP
<input type="checkbox"/>	<input type="checkbox"/>	<input type="checkbox"/>	<input type="checkbox"/>	<input type="checkbox"/>
S	LS	SC	BE	C

EXISTING CONDITIONS

The majority of the existing HVAC equipment appears to have MERV 8 filters. These filters do not meet the requirements set forth by the Maine Department of Education. It appears that the current maintenance schedule may be too infrequent for the current filtration standards, as there are several filters that appear to have caved in due to excess build up creating significant static pressure; this creates more work for the fans, therefore requiring higher electrical usage.

RECOMMENDATIONS

Maine Department of Education document *Public School Standards & Guidelines for New School Construction & Major Renovation Projects* lists as “required or recommended” filters with Minimum Efficiency Reporting Value of MERV 13 in HVAC equipment, with a MERV 11 minimum if higher-rated filters are not provided by the unit manufacturer. As HVAC equipment gets replaced, provide filtration to meet this requirement on new equipment. It is not recommended to provide MERV 13 filters for the existing units, as the fans were likely not built to handle the additional static pressure. Also, it is recommended that the maintenance schedule for replacement of filters is modified to a more frequent replacement schedule due to the higher filtration rating, which causes filters to load up faster to the maximum static pressure that the fan can handle; deeper cartridge style final filters, and an additional set of lower-MERV prefilters can extend this time. Filter pressure drop monitoring devices should be provided to alert maintenance staff to the need for filter changes. Maintenance reminders may also be built into the building automation (controls) system.



SCOPE OF WORK

As HVAC equipment gets replaced, provide MERV 13 filters; provide MERV 11 as a minimum if space and/or fan power for MERV 13 filters are not provided by the unit manufacturer. Filters which rely on an electret charge to achieve their rating will lose efficiency more quickly. Wherever possible, filters shall have a MERV-A rating, which is obtained under ASHRAE Standard 52.2 Appendix J without reliance on any electret charge. However, in equipment which is limited to 2-inch filter thickness, filters rated with an electret charge may be used to achieve the MERV ratings. Modify filter maintenance schedules to accommodate the anticipated time before filters are fully loaded with dust. Provide filter pressure drop monitoring devices, and maintenance reminders in the building automation system (BAS).

Provide Exhaust at Copier-Printers

Lack proper ventilation per Code
 May require additional exhaust fans

RELATED SCOPES OF WORK

Not Applicable

EM-ALL-M-3031	
Priority	Cost
	\$
Coordination by Discipline	
<input checked="" type="checkbox"/>	<input checked="" type="checkbox"/>
<input checked="" type="checkbox"/>	<input checked="" type="checkbox"/>
<input checked="" type="checkbox"/>	<input type="checkbox"/>
<input type="checkbox"/>	<input type="checkbox"/>
<input type="checkbox"/>	<input type="checkbox"/>
<input type="checkbox"/>	<input type="checkbox"/>
<input type="checkbox"/>	<input type="checkbox"/>
S	C

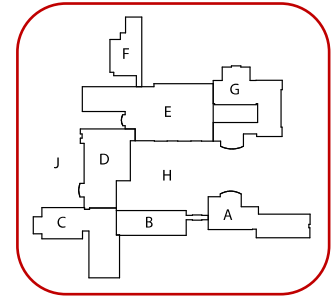

EXISTING CONDITIONS

Copiers and printers generally do not have local exhaust to remove fumes and odors, as required by current Codes.

RECOMMENDATIONS

Provide local exhaust with a grille above any copiers and printers. Duct to existing exhaust systems when suitable and having available capacity. Provide additional exhaust fans where necessary.

SCOPE OF WORK

Provide ceiling or wall exhaust grilles or registers. Provide exhaust ductwork to exhaust fans. Where it is necessary to add exhaust fans, provide outdoor terminations such as wall louvers or roof hoods, building penetrations, and electrical power. Provide controls to operate the fans continuously during occupied hours, including during nearby zone overrides.

Provide Cooling for Summer Programs

Most student spaces lack AC
Summer school a growing need

RELATED SCOPES OF WORK

M-D154-M-2035

EM-ALL-M-3032				
Priority	Cost			
	\$\$\$			
Coordination by Discipline				
<input checked="" type="checkbox"/>	<input checked="" type="checkbox"/>	<input checked="" type="checkbox"/>	<input checked="" type="checkbox"/>	<input type="checkbox"/>
A	M	E	P	FP
<input checked="" type="checkbox"/>	<input type="checkbox"/>	<input type="checkbox"/>	<input type="checkbox"/>	<input type="checkbox"/>
S	LS	SC	BE	C

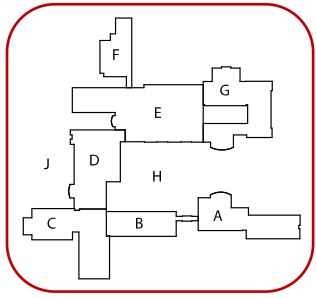

EXISTING CONDITIONS

Most of the rooms used by students do not have air conditioning or dehumidification. Summer school and similar programs for children and others are a growing need and interest in the community. Summer weather has trended hotter and more humid in recent years. In addition to the comfort concerns, uncontrolled humidity can damage building materials and other items, and can potentially cause mold issues, which affect both building occupants and materials. The Maine Department of Education Public School Standards and Guidelines for New School Construction & Major Renovation Projects requires or recommends air conditioning in spaces used year-round such as auditoriums, and spaces needed for summer school programs. It also recommends (as a premium) dehumidification systems for summer use in general areas, and specialized dehumidification systems for gymnasiums with wood floors.



RECOMMENDATIONS

Provide air conditioning in spaces used year-round including auditoriums, and in spaces for summer programs. Provide dehumidification in gymnasiums with wood floors.

SCOPE OF WORK

Provide engineering and architecture services. Remove HVAC equipment and ductwork that is not suitable for air conditioning. Provide air-conditioning systems and dehumidification, and associated ductwork and piping. Where possible, provide air-conditioning systems with 100%-outside-air economizer cooling capability, which some systems such as ductless split systems are not capable of. Provide digital controls connected to the building central control system. Provide structural supports and modifications, building openings and flashing, and electrical power supplies.

Mechanical Equipment Numbering & Nameplates

Several duplicate equipment numbers
RELATED SCOPES OF WORK
 Not Applicable

EM-ALL-M-3033				
Priority	Cost			
	\$			
Coordination by Discipline				
<input type="checkbox"/>	<input checked="" type="checkbox"/>	<input checked="" type="checkbox"/>	<input type="checkbox"/>	<input type="checkbox"/>
A	M	E	P	FP
<input type="checkbox"/>	<input type="checkbox"/>	<input type="checkbox"/>	<input type="checkbox"/>	<input type="checkbox"/>
S	LS	SC	BE	C

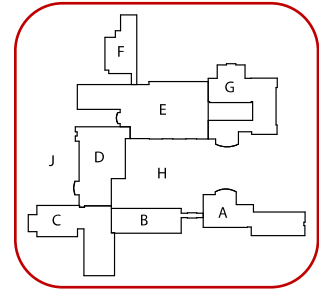

EXISTING CONDITIONS

There are currently several pieces of equipment throughout the building with duplicate equipment numbering or no known equipment number. For example, there are several units tagged EF-1, AHU-1, and IH-1, among others. There are several pieces of equipment without nameplates indicating make, model, serial number, and general performance data. Several pieces of equipment include nameplates which are faded or otherwise difficult to read, and some include incomplete data. Many items have duplicate serial numbers.

RECOMMENDATIONS

Provide a building-wide mechanical equipment numbering scheme such that no two items receive the same number. Provide riveted engraved acrylic nameplates affixed to each piece of equipment bearing the unit number, make, model, serial number, and general performance. Install nameplates such that dismantling of equipment is not necessary to view the nameplate in full. Recommend including all pieces of HVAC equipment including unit ventilators, exhaust fans, unit heaters, air handling units, and any other piece of equipment serving the HVAC systems. Such a system will provide clarity for ease of maintenance and will allow for a comprehensive operations and maintenance database.

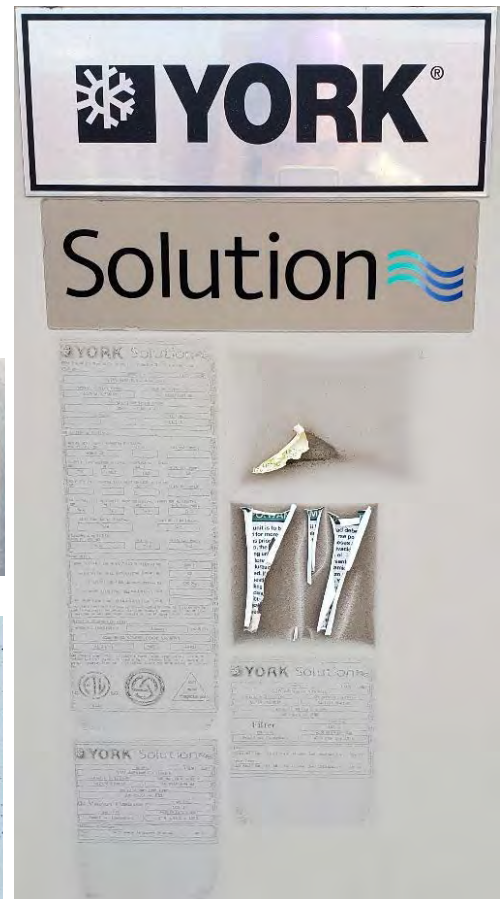
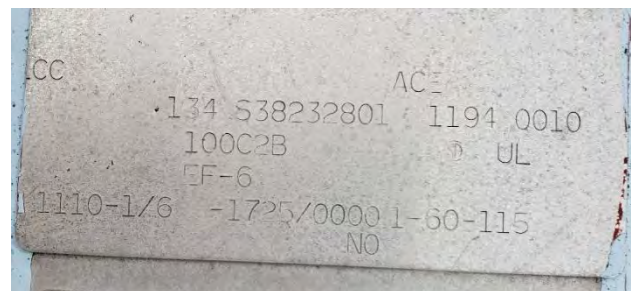

SCOPE OF WORK

Provide a building-wide mechanical equipment numbering scheme such that no two items receive the same number. Provide riveted engraved acrylic nameplates affixed to each piece of equipment bearing the unit number, make, model, serial number, and general performance. Coordinate updated numbering scheme with maintenance staff. Provide complete drawings indicating updated numbering scheme. Coordinate this work item with mechanical equipment replacement work items.

Reseal Existing Ductwork to Remain

Ducts to remain should be resealed
Will increase efficiency and IAQ

RELATED SCOPES OF WORK

Not Applicable

EM-ALL-M-3034	
Priority	Cost
	\$\$
Coordination by Discipline	
<input type="checkbox"/>	<input checked="" type="checkbox"/>
A	M
<input type="checkbox"/>	<input type="checkbox"/>
S	LS
<input type="checkbox"/>	<input type="checkbox"/>
E	P
<input type="checkbox"/>	<input type="checkbox"/>
SC	BE
<input type="checkbox"/>	<input type="checkbox"/>
C	C

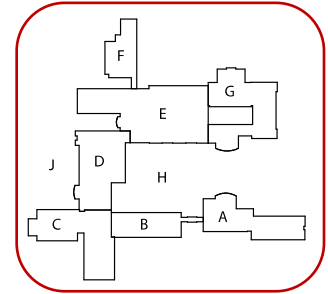

EXISTING CONDITIONS

Older ductwork has its original seam and joint sealant, which was not always applied to the level required by today's Codes. Sealants harden and deteriorate as they age, leading to increased leakage both into and out of the ductwork. Leaking ducts waste energy, and because air leaks out where it isn't wanted, reduce ventilation effectiveness where it is wanted, and cause improper pressure relationships in the building. The leaks can also result in a replacement air handling unit being unable to perform as designed, when airflows are measured at the rooms where the air is needed.



RECOMMENDATIONS

Reseal ducts when air handling equipment is replaced, including but not limited to supply and circulation systems and exhaust fans.

NEXT LEVEL

Proactively seal ducts serving systems where the equipment is not to be replaced in the near future.

SCOPE OF WORK

Reseal ducts prior to associated equipment replacement and its testing and balancing. Remove duct insulation and other concealments to allow complete sealing. Include sealing of transverse and longitudinal joints and seams, and penetrations. Use duct sealants which are UL listed as compliant with relevant air system Codes and standards. Sealants may include mastics with or without embedded reinforcing tape, but may not include self-adhesive "duct tape" and similar products with limited life span. Reinsulate and re-enclose ductwork after air testing and balancing is complete.

Increase Ventilation for Improved IAQ

Increase to or above current Codes
May reduce student and staff illness

RELATED SCOPES OF WORK

Not Applicable

EM-ALL-M-3035				
Priority	Cost			
	\$\$			
Coordination by Discipline				
<input checked="" type="checkbox"/>	<input checked="" type="checkbox"/>	<input checked="" type="checkbox"/>	<input type="checkbox"/>	<input type="checkbox"/>
A	M	E	P	FP
<input type="checkbox"/>	<input type="checkbox"/>	<input type="checkbox"/>	<input type="checkbox"/>	<input type="checkbox"/>
S	LS	SC	BE	C

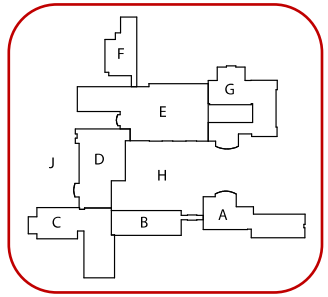

EXISTING CONDITIONS

Existing ventilation systems were designed to meet ventilation codes in use during original design and construction. Codes and other standards have increased their requirements and recommendations for quantities of outside air supply, and requirements for good distribution of the air for ventilation effectiveness.



RECOMMENDATIONS

Comply with the Maine Department of Education’s Public School Standards & Guidelines for New School Construction & Major Renovation Projects. Increase outside air supply quantities to occupied spaces, to levels at or above current Codes and standards. Modify distribution of air to ensure it is effectively distributed to the occupants’ breathing zone. Provide energy recovery where practical, and increased heating (and cooling, where applicable) to the supply airstream as necessary. Improving the indoor air quality in these ways can lead to improved environment and improved health of students and staff.

SCOPE OF WORK

Provide design and testing services to verify existing outside airflows, both as designed and as currently operating. Compare these to current Codes and standards. Provide equipment and ductwork as required to achieve increased outside airflows where required. Provide modifications or replacements of supply terminal diffusers and registers to distribute the air to the occupants in the most effective and efficient manner. Provide additional exhaust and relief to outdoors as required for proper building pressurization. Provide energy recovery where practical, and increased heating (and cooling, where applicable) to the supply airstream as necessary. Provide architectural modifications such as roof penetrations and supports as required. Provide electrical power and controls as necessary.

Provide Full Commissioning of HVAC Systems

Verify and repair system operations

RELATED SCOPES OF WORK

Not Applicable

EM-ALL-M-3036				
Priority	Cost			
	\$\$\$			
Coordination by Discipline				
<input type="checkbox"/>	<input checked="" type="checkbox"/>	<input checked="" type="checkbox"/>	<input checked="" type="checkbox"/>	<input type="checkbox"/>
A	M	E	P	FP
<input type="checkbox"/>	<input type="checkbox"/>	<input type="checkbox"/>	<input type="checkbox"/>	<input type="checkbox"/>
S	LS	SC	BE	C

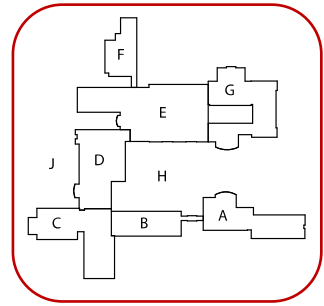

EXISTING CONDITIONS

The Maine Department of Education Public School Standards and Guidelines for New School Construction & Major Renovation Projects lists commissioning as “required or recommended.” Commissioning is a relatively new field, and likely was not part of the previous construction. As systems age, re-commissioning of existing systems and controls can be beneficial to make them operate as well as possible, and to discover and identify existing operational issues that are in need of further repairs. This leads to more effective HVAC systems, lower energy costs, and improved indoor air quality.



Commissioning is a process of testing systems to demonstrate that they operate as designed. Control sequences are confirmed by direct observation of items such as control valves and dampers.

RECOMMENDATIONS

Commission and re-commission building systems.

SCOPE OF WORK

In accordance with the Maine Department of Education Public School Standards and Guidelines for New School Construction & Major Renovation Projects, hire a 3rd party agent to perform commissioning. Enhanced commissioning should be done after occupancy to monitor systems performance. Systems to be commissioned per the DoE include: heating ventilation and cooling (HVAC), controls, lighting and power loads, and air barrier systems (applicable to newly constructed building exterior walls). Also commission plumbing systems with controls, such as water heating and circulation.

Provide Room Sensors with Occupant Adjustment

Most room controls have blank covers
Adjustment can improve thermal comfort

RELATED SCOPES OF WORK

EM-ALL-E-3021

E-A127-M-1020

EM-ALL-M-3037				
Priority	Cost			
	\$\$\$			
Coordination by Discipline				
<input type="checkbox"/>	<input checked="" type="checkbox"/>	<input checked="" type="checkbox"/>	<input type="checkbox"/>	<input type="checkbox"/>
A	M	E	P	FP
<input type="checkbox"/>	<input type="checkbox"/>	<input type="checkbox"/>	<input type="checkbox"/>	<input type="checkbox"/>
S	LS	SC	BE	C

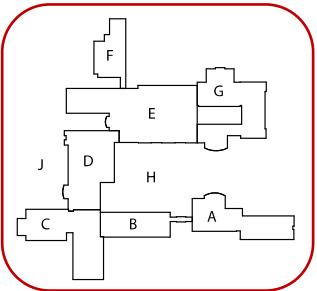

EXISTING CONDITIONS

The Maine Department of Education Public School Standards and Guidelines for New School Construction & Major Renovation Projects lists as “required or recommended” individual room controls, including the use of operable windows. Most of the existing occupied rooms have operable windows. In the rooms that have DDC (direct digital control) room temperature control, most of the wall-mounted sensors have blank covers with no occupant-accessible settings. Occupants may want to adjust the sensors’ temperature setpoints to coordinate with their use of the space and the windows, as well as their personal comfort needs.



RECOMMENDATIONS

Provide occupant adjustable wall-mounted room DDC temperature sensors, with user temperature adjustment dials or sliders, programmed in the DDC system to limit ranges of adjustment and to reset them each day.

SCOPE OF WORK

Modify controls in rooms where occupant adjustment is desired. In rooms with DDC sensors, remove existing blank-cover DDC sensors, and provide sensors with occupant adjustment devices; replace or augment any incompatible wiring and controllers as necessary. In occupied rooms which don’t yet have DDC, remove the wall thermostats, provide DDC wall sensors, controllers, and compatible wiring, and provide programming.

Provide Corridor Ventilation

Corridors generally lack ventilation in quantity or effective distribution

RELATED SCOPES OF WORK

EM-A110-M-3039

EM-ALL-M-3038	
Priority	Cost
	\$\$\$
Coordination by Discipline	
<input checked="" type="checkbox"/>	<input checked="" type="checkbox"/>
<input checked="" type="checkbox"/>	<input checked="" type="checkbox"/>
<input checked="" type="checkbox"/>	<input type="checkbox"/>
<input type="checkbox"/>	<input type="checkbox"/>
A	M
E	P
FP	
<input type="checkbox"/>	<input type="checkbox"/>
<input type="checkbox"/>	<input type="checkbox"/>
<input type="checkbox"/>	<input type="checkbox"/>
S	LS
SC	BE
C	

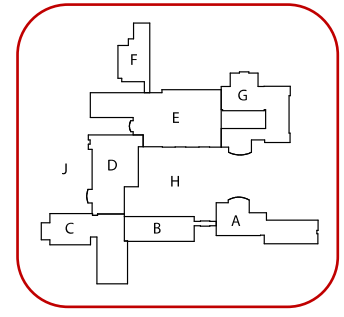

EXISTING CONDITIONS

Several of the corridors and lobbies lack ventilation supply outlets, or have few outlets which are poorly distributed. Examples include the Middle School entry lobby, and long corridors with a single short linear diffuser aimed downward.



RECOMMENDATIONS

Provide additional ventilation supply air, and improved distribution, in corridors and similar spaces, to comply with International Mechanical Code (IMC) 2015, Chapter 4 Ventilation, regarding outside air quantity and effectiveness of distribution..

SCOPE OF WORK

Provide design services to determine proper ventilation supply air quantities. Provide new air handling equipment, including ductwork and supply air outlets located for good ventilation effectiveness, to reach the breathing zones of occupants who will typically be transient. Adjust outlets of existing linear diffusers in corridors, so that instead of blowing downward they blow sideways down the length of the corridors. Replace standard 4-way diffusers in corridors with 2-way type to direct the airflow down the length of the corridors. Provide additional heating (and cooling, where applicable) as necessary. Remove and replace ceilings as required for routing ductwork.

Quiet Room Ventilation

83 square foot A-wing quiet room, and 102 square foot C-wing quiet room require ventilation.

RELATED SCOPES OF WORK

EM-ALL-M-3038

EM-A110-M-3039	
Priority	Cost
	\$
Coordination by Discipline	
<input checked="" type="checkbox"/>	<input checked="" type="checkbox"/> <input type="checkbox"/> <input type="checkbox"/> <input type="checkbox"/>
A	M E P FP
<input type="checkbox"/>	<input type="checkbox"/> <input type="checkbox"/> <input type="checkbox"/> <input type="checkbox"/>
S	LS SC BE C

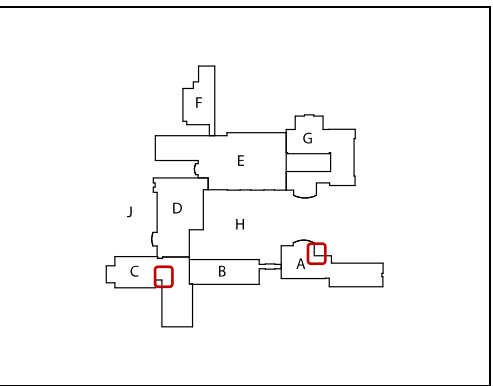

EXISTING CONDITIONS

There are currently two quiet rooms located in the elementary school. One is an 83 square foot room located in the A-wing, adjacent to the media center, labeled as room A110 for the purposes of this document. The other is a 102 square foot room located in the C-wing, adjacent to the special education space. Neither room has sufficient ventilation.

RECOMMENDATIONS

Provide ventilation for each room, based on ASHRAE 62.1 ventilation requirements for a classroom of 10 cfm per person and 0.12 cfm per square foot. Assuming an occupancy of two people per space, one student and one staff member, room A110 therefore requires 30 cfm of outdoor air, and room C124A requires 33 cfm of outdoor air. It appears that the C-wing room is part of the spaces served by variable air volume system box number VV-14, and may be ducted from VV-14 upon confirmation that VV-14 has sufficient capacity to provide 33 cfm of additional outdoor air. Similarly, room A110 may be ducted from media center A105's ventilation system upon confirmation that it has sufficient capacity to provide the 30 cfm extra that is required for this space. In the instance that one or both of these systems does not have sufficient capacity, these spaces may be ventilated as part of the corridor ventilation work item EM-ALL-M-3038.

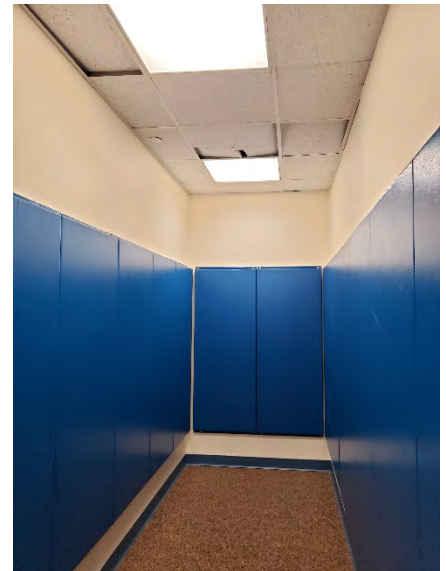

SCOPE OF WORK

Provide ductwork including insulation, volume dampers, supply diffusers, and return grilles for each of two spaces. Connect ductwork to either existing systems serving A and C wings, or to new systems serving corridors as a part of the corridor ventilation work item EM-ALL-M-3038. Provide duct lining and at least two elbows for each duct serving these spaces, to minimize sound transfer. Balance systems to new overall airflows. Support ductwork above the ceiling and provide a maximum of five feet of flex duct at each diffuser and grille.

Clean Existing Ductwork to Remain

Clean ductwork inside, repair linings
Heavy dust seen near air handlers

RELATED SCOPES OF WORK

Not Applicable

EM-ALL-M-3040	
Priority	Cost
	\$
Coordination by Discipline	
<input checked="" type="checkbox"/>	<input checked="" type="checkbox"/> <input type="checkbox"/> <input type="checkbox"/> <input type="checkbox"/>
A	M E P FP
<input type="checkbox"/>	<input type="checkbox"/> <input type="checkbox"/> <input type="checkbox"/> <input type="checkbox"/>
S	LS SC BE C

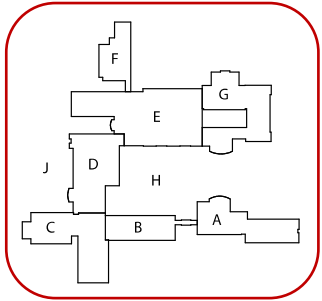

EXISTING CONDITIONS

Heavy dust buildup is seen inside ductwork near rooftop air handling and heat recovery units. Filters in these units receive a lot of dust and pollen, and because of imperfect fit and some overloading they allow some air to bypass unfiltered. Dust buildup is also seen at terminal inlet and outlet grilles and diffusers. Schools bring in large amounts of outdoor air which bears humidity as well as outdoor contaminants such as dust and pollen, and have large dense populations of people who generate dust and other contaminants. Ducts can store these contaminants and distribute them to the occupants, and in some conditions such as high humidity the dirty duct surfaces can promote unhealthy biological growth. Periodic duct cleaning has become standard practice in many schools and other buildings, to promote healthy indoor air quality (IAQ).



RECOMMENDATIONS

Have the interiors of ductwork cleaned by an experienced and reputable service specializing in duct cleaning. Prioritize supplies, returns, transfers, and exhausts in order of their potential for exposing occupants to contaminants.

NEXT LEVEL

Replace existing duct acoustic and insulating linings in ducts and air handling equipment, with new materials of same or equal performance to eliminate loose fibers and crumbling foams as sources of airborne particles and residual contaminants.

SCOPE OF WORK

Provide the services of an independent duct cleaning company. Perform an initial inspection to verify the existing state of HVAC system cleanliness, and to locate any suspected hazardous materials that may require abatement prior to the cleaning process. Provide access openings in ducts and building assemblies as required, and upstream of any coils including heating coils integral to variable air volume (VAV) boxes, and provide removable access doors and access panels in the openings for future access. Clean the interiors of ducts, duct coils, and other surfaces using mechanical, vacuum, and other methods, as recommended by The National Air Duct Cleaners Association (NADCA) in their latest ACR standard for assessment, cleaning, and restoration of HVAC systems. Perform inspections and testing to verify cleaning as recommended. Protect occupants, and protect smoke detectors and other fire detection and control devices in ductwork systems, during the cleaning processes. Identify any damaged materials such as acoustic linings, and replace them with new.

Replace Damaged Diffusers and Grilles

Diffusers and grilles have damage
Most remain functional

RELATED SCOPES OF WORK

Not Applicable

EM-ALL-M-3041	
Priority	Cost
	\$
Coordination by Discipline	
<input checked="" type="checkbox"/>	<input checked="" type="checkbox"/> <input type="checkbox"/> <input type="checkbox"/> <input type="checkbox"/>
A	M E P FP
<input type="checkbox"/>	<input type="checkbox"/> <input type="checkbox"/> <input type="checkbox"/> <input type="checkbox"/> <input type="checkbox"/>
S	LS SC BE C

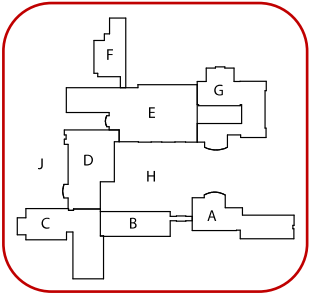

EXISTING CONDITIONS

Some air diffusers, grilles, and registers have damage. Most remain functional to deliver the air.



RECOMMENDATIONS

Replace damaged units to allow for intended airflow performance and patterns. Where subject to repeated damage they may be upgraded to sturdier types for improved resilience.

SCOPE OF WORK

Determine required airflows and performance. Remove devices, and replace with new meeting the requirements. Fasten and seal to ductwork. Adjust air pattern vanes and other accessories. Rebalance airflows. It is additionally recommended to measure airflows of existing devices before doing any work, and to coordinate existing airflows with design expectations.

Remove Abandoned Boiler Room Intake

Eliminate unsecure outdoor louver and energy loss

RELATED SCOPE OF WORK

Not Applicable

EM-BSMT-M-3042				
Priority	Cost			
	\$			
Coordination by Discipline				
<input checked="" type="checkbox"/>	<input checked="" type="checkbox"/>	<input type="checkbox"/>	<input type="checkbox"/>	<input type="checkbox"/>
A	M	E	P	FP
<input type="checkbox"/>	<input type="checkbox"/>	<input checked="" type="checkbox"/>	<input checked="" type="checkbox"/>	<input type="checkbox"/>
S	LS	SC	BE	C

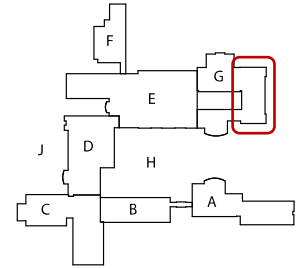

EXISTING CONDITIONS

Duct and motorized damper appear to be abandoned combustion air ductwork for a boiler formerly in this space. Duct is a source of air leakage and heat loss. Damper motor needs to be maintained. A low louver would require adding burglar bars under another work item to provide a secure opening to meet the intent of the Maine Department of Education’s Public School Standards & Guidelines for New School Construction & Major Renovation Projects.

RECOMMENDATIONS

Remove the duct, damper, and outdoor louver. Provide architectural infill of the opening with insulation, or a window to match the adjacent one.



SCOPE OF WORK

Remove ductwork, motorized damper, and actuator. Return the actuator to the Owner if in good condition. Remove control wiring, junction boxes, and conduit back to their source. Provide suitable masonry infill, or a durable and entry-resistant metal panel with fire-safe insulation on the indoor side, or a thermal-pane window and trim to match the adjacent window.

Replace Cast Iron Radiators with Cooler Types

Radiators and pipes hot to touch

RELATED SCOPES OF WORK
M-G128-LS-2017

EM-ALL-M-3043				
Priority		Cost		
		\$\$		
Coordination by Discipline				
<input checked="" type="checkbox"/>	<input checked="" type="checkbox"/>	<input checked="" type="checkbox"/>	<input type="checkbox"/>	<input type="checkbox"/>
A	M	E	P	FP
<input type="checkbox"/>	<input checked="" type="checkbox"/>	<input type="checkbox"/>	<input type="checkbox"/>	<input type="checkbox"/>
S	LS	SC	BE	C

EXISTING CONDITIONS

Cast iron radiators are original to the 1934 portion of the building. The outer surfaces of the radiators and their piping are exposed to the students' touch. The hot water supply temperature might typically be 180 degrees F or up to 200 F. OSHA limits surface temperatures to 140 F (by indirect reference to ASTM C1055), in a zone up to 7 feet above the floor in occupied and service spaces. A general industry consensus is that surface temperatures above 111 F can burn with a long enough contact time, and a surface temperature of 140 F can only be touched by a healthy adult for 5 seconds before a serious burn occurs (these temperatures and times have not been independently verified by the Engineer). Children, the elderly, and the physically or mentally impaired, can be more susceptible to burns, or unable to pull themselves away quickly enough.



RECOMMENDATIONS

Provide new hydronic heaters that have lower surface temperatures. Examples include fintube radiation with metal enclosures in spaces with long walls such as classrooms, and fan-forced heaters in tight spaces such as stairways and vestibules. Route piping directly down through floors below the heaters so they are not generally subject to being touched. If the piping must be exposed at up to 7 feet above floor provide insulation to prevent burns. Provide new controls as required. Patch wall and floor surfaces to match surroundings. Provide electrical power as necessary.

SCOPE OF WORK

Remove radiators, piping, and controls. Patch and refinish building surfaces such as floors, walls, and partitions to match surrounding surfaces. Provide building penetrations, wall blocking, and other items as required. Install new heaters, piping, insulation, pipe sleeves, and DDC controls. Provide electrical power circuits, wiring, and conduits as necessary for fan-powered heaters. Firestop penetrations to maintain building assembly ratings. Seal penetrations for water and smoke as required. Balance air and water flows.

Kitchen Hood Switch Location

Switches high on hood, hard to reach
Interlock of fan and cooking not seen

RELATED SCOPES OF WORK

M-D131-FP-2016

EM-D131-M-3045				
Priority	Cost			
	\$			
Coordination by Discipline				
<input checked="" type="checkbox"/>	<input checked="" type="checkbox"/>	<input checked="" type="checkbox"/>	<input type="checkbox"/>	<input type="checkbox"/>
A	M	E	P	FP
<input type="checkbox"/>	<input type="checkbox"/>	<input type="checkbox"/>	<input type="checkbox"/>	<input type="checkbox"/>
S	LS	SC	BE	C

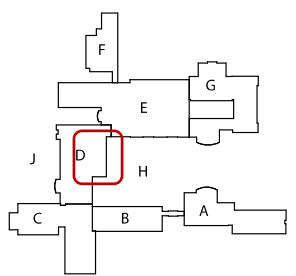

EXISTING CONDITIONS

The switches for the kitchen hood's lights, supply fan, and exhaust fan are mounted on the end of the hood well over 6 feet above the floor. It appears that the hood fan operation is not interlocked with cooking operation as is required by current Codes. There is a sticker cautioning users to turn on the fan before starting up appliances, which is not in sight from the user's cooking position.



RECOMMENDATIONS

Relocate the hood switches to a wall location within ADA reachable height to meet code requirements. Provide controls to interlock the exhaust fan and makeup-air supply fan with the cooking operation; the typical method is to use heat sensors above the cooking appliances to sense when cooking occurs; many appliances do not have internal controls that can be used for this function.

NEXT LEVEL

Provide variable speed drives or equivalent on the exhaust and supply fan motors. Provide a control system which varies fan speeds based on the temperatures above the appliances or in the exhaust duct, as well as on the detection of smoke.

SCOPE OF WORK

1. Base Level: Relocate the hood switches to a wall location within ADA reachable height; provide surface-mounted box and conduit on the CMU partition. Provide a system of controls to interlock the exhaust fan and makeup-air supply fan with the cooking operation. The controls would include: heat sensors above the cooking appliances to sense when cooking occurs; interfacing controller between these sensors and the fan motor starters as required; and interface between the fan controller and the wall switches to allow manual override on, but prevent using the wall switches to manually stop the fan during cooking. The fan switches would be consolidated to a single switch.
2. Next Level: Provide the Base Level, plus a packaged controller such as MeLink or CaptiveAire to provide variable speed control of the fans proportionate to the cooking temperature or smoke sensing above the appliances or in the exhaust duct. Provide variable speed control devices on each fan, to vary fan speed in response to proportional control signals, such as additional variable frequency drives (VFDs) or replacement electronically-commutated motors (ECMs).

Move Plumbing Vents from Air Intakes

Some plumbing vents above roof are too close to air intakes and other inlets

RELATED SCOPES OF WORK

- M-E163-M-2023
- E-ROOF-M-1023
- M-ROOF-M-2032

EM-ALL-P-3046				
Priority		Cost		
		\$\$		
Coordination by Discipline				
<input checked="" type="checkbox"/>	<input checked="" type="checkbox"/>	<input checked="" type="checkbox"/>	<input checked="" type="checkbox"/>	<input type="checkbox"/>
A	M	E	P	FP
<input type="checkbox"/>	<input type="checkbox"/>	<input type="checkbox"/>	<input type="checkbox"/>	<input type="checkbox"/>
S	LS	SC	BE	C

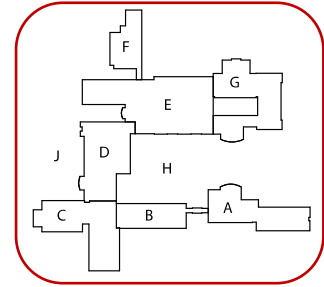

EXISTING CONDITIONS

Several plumbing vent pipes through roof are less than the Code-required minimum of 10 feet from air intakes, or from other potential air inlets such as operable windows. Most of these pipes appear to have been existing when many of the rooftop air handling units were added in the 1994 era remodel.



RECOMMENDATIONS

Relocate the vents through the roof to more than 10 feet away from any current air inlets and operable windows to meet separation distances required by code.

NEXT LEVEL

Coordinate with replacements of the rooftop HVAC units, such as the heat recovery units (HRUs). Locate plumbing vents relative to the new HVAC units, which may have different intake air locations. Coordinate with any replacement of roofing and increase in roof insulation thickness.

SCOPE OF WORK

Remove vent piping through the roof to a suitable point below the roof. Patch the roofing including deck, insulation, protection board, and membrane. Provide new roof penetrations with cone-type flashing to the membrane. Provide piping to the new location; increase size of risers as necessary so that any piping through the roof is at least 3-inch size to reduce frost closure. Extend open ends to 24 inches above the finished roof surface; include height for any anticipated increase in roof insulation thickness that may be part of a future work item.

Provide Emergency Plumbing Fixtures

Science lab classrooms lack fixtures.
Where showers exist, they lack drains.

RELATED SCOPES OF WORK

Not Applicable

EM-ALL-P-3047	
Priority	Cost
	\$\$
Coordination by Discipline	
<input checked="" type="checkbox"/>	<input type="checkbox"/>
<input type="checkbox"/>	<input checked="" type="checkbox"/>
<input type="checkbox"/>	<input type="checkbox"/>
A	FP
<input type="checkbox"/>	<input type="checkbox"/>
<input type="checkbox"/>	<input type="checkbox"/>
S	C
LS	BE
SC	

EXISTING CONDITIONS

Middle school science laboratory classrooms do not contain emergency eyewash or shower fixtures. Some janitor spaces utilize self-contained eyewash stations, which may not fully comply with OSHA standards, and clear access isn't being maintained. The Maine Department of Education document *Public School Standards & Guidelines for New School Construction & Major Renovation Projects* requires emergency eyewash and showers for science laboratory classrooms. Where any emergency showers exist they do not all have floor drains, which may inhibit use and testing due to the potential for water damage, and may not have tepid water as required by code. Eyewash in Kitchen D131 is not ADA accessible and has only cold water rather than tepid.

RECOMMENDATIONS

Provide at each middle school science classroom a plumbed combination emergency unit with eyewash or eye/face wash and shower, and provide a floor drain and piping. Provide floor drains at any existing showers that do not have drains. Provide at each janitor closet or space utilizing chemicals an emergency eyewash or eye/face wash, which may be plumbed or self-contained ("portable") type. Provide ADA accessibility where applicable, and replace any existing emergency fixtures which do not have adequate accessibility for the location. Provide replacement emergency fixtures to meet ADA accessibility including at Kitchen D131. Provide tepid water supplies to plumbed emergency fixtures, including existing ones which have only cold water; do not downgrade these locations to non-plumbed type.

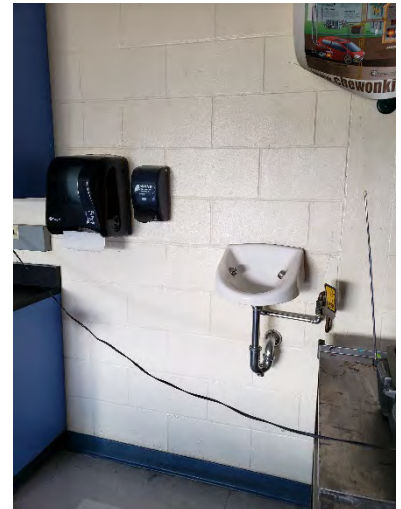

SCOPE OF WORK

Provide eyewashes or eye/face washes, with showers and floor drains sized for the shower flow rate where applicable. At plumbed (not self-contained/portable) emergency fixtures, provide hard-piped sanitary drain and vent piping for eyewash (or eye/face wash) bowls, and piped tepid water supply with an approved-type tempering valve with thermometer set to between 60°F and 90°F at each fixture. Water supplies shall conform to ANSI/ISEA Z358.1 as required by Maine's plumbing code in the Uniform Plumbing Code (UPC) 2015 Chapter 416.2. At each tempering valve provide domestic hot and cold water piping, and provide recirculated hot water piping to near the tempering valve to shorten the waiting time for tepid water. Provide sanitary and vent piping at floor drains, sized for the shower flow rate of 20 gpm for 15 minutes. Provide proper signage, and designate and permanently mark clear floor and other access areas to be maintained at all times. Provide architectural design and modifications of spaces and access at emergency fixtures, and architectural finishes and trim as required.

Provide Automatic Sensor Control at Fixtures

Provide 70 hard-wired automatic flushometers for toilets at 1.28 gpf, 13 hard-wired automatic flushometers for urinals at 0.5 gpf, and 64 hard-wired automatic lavatory sensors at 1.5 gpm with aerators.

RELATED SCOPES OF WORK

Not Applicable

EM-ALL-P-3048				
Priority	Cost			
	\$\$\$			
Coordination by Discipline				
<input checked="" type="checkbox"/>	<input type="checkbox"/>	<input checked="" type="checkbox"/>	<input checked="" type="checkbox"/>	<input type="checkbox"/>
A	M	E	P	FP
<input type="checkbox"/>	<input type="checkbox"/>	<input type="checkbox"/>	<input type="checkbox"/>	<input type="checkbox"/>
S	LS	SC	BE	C

EXISTING CONDITIONS

Existing lavatory fixtures are a mixture of automatic and manual operation. Existing fixtures are non-uniform throughout and vary including multi-faucet automatic lavatory stations to individual vitreous china manual lavatories, and toilets vary including both floor and wall-mounted units with both manual and automatic flushometers.

RECOMMENDATIONS

Provide 70 hard-wired automatic flushometers for toilets and 13 hard-wired automatic flushometers for urinals, and 64 hard-wired automatic sensors for lavatories to meet the Maine Department of Education requirements. The hard-wired units provide greater reliability than battery-operated units. Provide fixtures compliant with EPA

WaterSense maximum allowable flow rates of 1.28 gpf for toilets, 0.5 gpf for urinals, and 1.5 gpm for lavatories, where feasible. Aerators may be provided at lavatories, and a 15-second automated duration may be utilized. Provide new fixtures where the existing cannot support automatic sensors. In the instance that an automatic sensor is fitted to an existing water closet or urinal, the sensor flow rate must match the fixture flow rate.

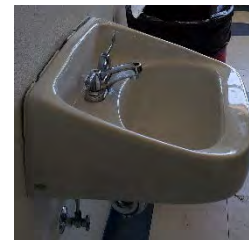
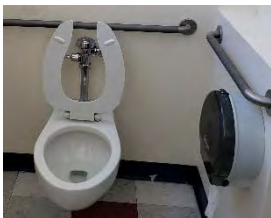

SCOPE OF WORK

Maine Department of Education issued the document titled *Public School Standards & Guidelines for New School Construction & Major Renovation Projects* which requires automatic controls at sinks and toilets. Provide hard-wired flushometers for toilets and urinals, and automatic sensors for lavatories. Provide fixtures compliant with EPA WaterSense maximum allowable flow rates of 1.28 gpf for toilets, 0.5 gpf for urinals, and 1.5 gpm for lavatories. Aerators may be provided at lavatories, and a 15-second automated duration may be utilized. Provide electrical wiring for flushometers and lavatory sensors. Provide new fixtures where the existing cannot support automatic sensors.

Domestic Hot Water Pressure and Response Time

Low pressure, long wait for hot water

RELATED SCOPES OF WORK

M-E163-P-2044

EM-G-P-3049					
Priority	Cost				
	\$				
Coordination by Discipline					
<input checked="" type="checkbox"/>	<input type="checkbox"/>		<input checked="" type="checkbox"/>	<input checked="" type="checkbox"/>	<input type="checkbox"/>
A	M		E	P	FP
<input type="checkbox"/>	<input type="checkbox"/>		<input type="checkbox"/>	<input type="checkbox"/>	<input type="checkbox"/>
S	LS	SC	BE	C	

EXISTING CONDITIONS

Pressure and wait time of hot water at fixtures is reportedly poor.

RECOMMENDATIONS

Repair or upgrade system to provide adequate pressure. Provide recirculation to near the fixtures farthest from the water heaters, to reduce wait time.

SCOPE OF WORK

Provide engineering services to recommend repairs and replacements in cooperation with building users. Remove piping and equipment as necessary, and install repairs and replacements. Provide electrical power supplies as required.

Provide Dual-Height Drinking Fountains

Provide dual-height drinking fountains with bottle fillers.

RELATED SCOPES OF WORK

Not Applicable

EM-ALL-P-3050				
Priority		Cost		
		\$\$\$		
Coordination by Discipline				
<input checked="" type="checkbox"/>	<input type="checkbox"/>	<input checked="" type="checkbox"/>	<input checked="" type="checkbox"/>	<input type="checkbox"/>
A	M	E	P	FP
<input type="checkbox"/>	<input type="checkbox"/>	<input type="checkbox"/>	<input type="checkbox"/>	<input type="checkbox"/>
S	LS	SC	BE	C

EXISTING CONDITIONS

There are currently several types of drinking fountains and water coolers throughout the building, including stainless steel, vitreous china, and vinyl, in both single and dual height applications. Ages and condition vary.

- Lobby C120 – single vinyl with bottle filler, 32”
- Kindergarten Lobby – dual stainless, 32.5” & 38”
- 4th Grade Corridor – single vinyl with bottle filler, 32”
- Corridor D117 – single vinyl with bottle filler, 32”
- Cafetorium D114 – single stainless with bottle filler, 33.5”
- Corridor F106 – single stainless, 33.5”
- Corridor E112 – single vinyl with bottle filler, 32.5”
- Corridor E144 – single stainless, 33”
- Corridor G102 – single vinyl with bottle filler, 35”
- Corridor G002 – single stainless, 35”
- Corridor G236 – single vinyl, 33.5”
- Work Area G004 – single vinyl, 33.5”
- Stair G227 top landing – single vitreous china, 29”

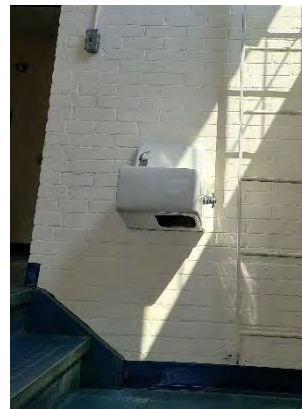

RECOMMENDATIONS

Remove fixture and piping from unsuitable location in stair G227. In other locations, provide dual-height drinking fountains (refrigerated water cooler type) with bottle fillers, wherever existing units do not meet ADA requirements or UPC code requirements for education occupancy type. See Appendix E for tabulated UPC 2015 requirements versus existing fixtures per school. Of new drinking fountains installed, half must be installed at wheelchair height and half at standing height; odd numbers may be rounded to either direction. For this building, primary use is by children ages 12 and under, so wheelchair height units must meet the requirements of ICC A117.1 and standing height must meet the height requirements of UPC and IBC. This means maximum height 30 inches for wheelchair-height fountains, and minimum height 30 inches for standing-height fountains. The classroom sink bubblers, where installed, do not appear to meet both requirements and therefore are not sufficient in lieu of drinking fountains. Wherever a single drinking fountain is installed, signage must be provided indicating the location of the nearest of the other height (wheelchair height or standing height). Recommended fixture: Halsey Taylor HydroBoost Bottle Filling Station & Bi-Level ADA cooler, in Platinum Vinyl finish (stainless finish optional), with filtration.

NEXT LEVEL

In addition to the base recommendation, remove all other existing drinking fountains and water coolers, and provide a uniform installation of new dual height drinking fountains with bottle fillers. Provide a minimum of 21 total units throughout the building to meet plumbing code requirements. 2015 UPC Table 422.1 requires 1 drinking fountain per 150 people.

SCOPE OF WORK

Remove existing drinking fountains, and prepare the locations to receive new water coolers. Provide dual height water coolers with bottle fillers. Install such that means of egress are not impeded, and with the wheelchair-height side located for best access at each cooler. Install the bottle filler on the lower wheelchair-height side of the fountain. Provide blocking in walls to support units; in partition types other than masonry, provide floor-mounted steel fixture carriers. Provide domestic cold-water piping with new shutoff valve to each fixture, and sanitary and vent piping. Provide power supplies, new or connection to existing. Provide architectural finishes and trim as required.

New Secure Entrance and Support Spaces

RELATED SCOPES OF WORK

EM-ALL-SC-3028
M-E-A-2007

EM-NEW-SC-3051				
Priority	Cost			
	\$\$\$\$			
Coordination by Discipline				
<input checked="" type="checkbox"/>	<input checked="" type="checkbox"/>	<input checked="" type="checkbox"/>	<input checked="" type="checkbox"/>	<input checked="" type="checkbox"/>
A	M	E	P	FP
<input checked="" type="checkbox"/>	<input checked="" type="checkbox"/>	<input checked="" type="checkbox"/>	<input checked="" type="checkbox"/>	<input checked="" type="checkbox"/>
S	LS	SC	BE	C

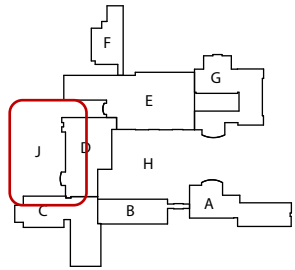

EXISTING CONDITIONS

At the middle school, visitors enter through a door monitored by a camera with card access control. Access is granted from the office, which does not have line of sight to the door. In order to check-in with the office, visitors walk down a long corridor alongside the cafeteria/auditorium until they reach the main office.

The elementary school entry is similar – visitors enter through a controlled door without line of sight control and without a secure vestibule. At the elementary school visitors pass by the gymnasium before reaching the school office.

In both cases, tailgating (entry behind the person in front of you without being independently verified) is common. Further, if corridor doors between the two schools are open, visitors can enter a portion of the building they weren't granted entry to.

RECOMMENDATIONS

Compliance with the Maine Department of Education's *Public School Standards & Guidelines for New School Construction & Major Renovation Projects* requirements include:

- Provide a locked security vestibule at the main entrance that allows visitors to enter the vestibule and be identified by the main office before they are approved for entrance into the school. The interior bank of doors of the vestibule should be equipped with one electronic strike that allows the door to be unlocked electronically by main office personnel after visitors have been approved for entrance.
- Provide a security window in the main entrance vestibule to enable main office personnel to maintain clear vision within the vestibule, and to greet visitors for security screening.
- Locate the main office directly adjacent to the vestibule to allow for visitor recognition and sign-in.

The design team recommends constructing an addition near the school entry which incorporates the following:

- A security vestibule for each school.
- Relocated main offices with clear vision and a security window to the security vestibule.

A diagrammatic layout is provided on the back-side of this sheet.

SCOPE OF WORK

The addition would include the following:

- (2) entry vestibules with inner doors that have electronic locksets / strikes, each approx. 800sf
- Security monitoring equipment (cameras, monitors, etc).
- Relocated elementary school offices, approx. 2500sf.
- Relocated middle school offices, approx. 2500sf.

Notes on Costing: Given that the scope of this work may vary greatly, please see costing sheet and associated back-up for relevant unit pricing.

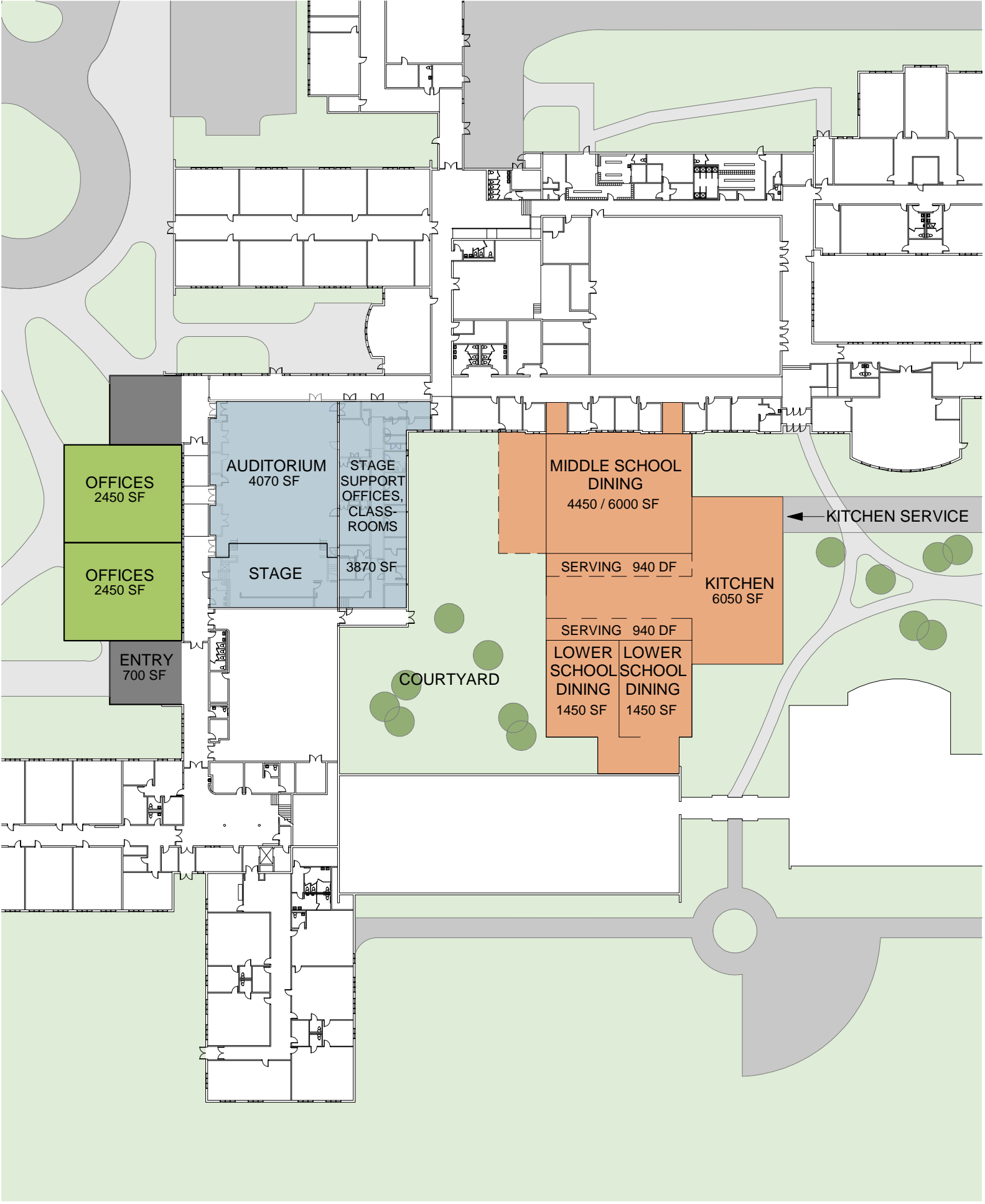

General Exterior Masonry Repair

RELATED SCOPES OF WORK

Not Applicable

EM-ALL-BE-3052				
Priority		Cost		
		\$\$\$		
Coordination by Discipline				
<input checked="" type="checkbox"/>	<input type="checkbox"/>	<input type="checkbox"/>	<input type="checkbox"/>	<input type="checkbox"/>
A	M	E	P	FP
<input type="checkbox"/>	<input type="checkbox"/>	<input type="checkbox"/>	<input checked="" type="checkbox"/>	<input type="checkbox"/>
S	LS	SC	BE	C

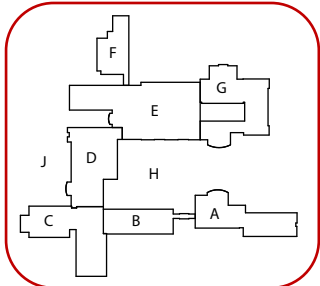

EXISTING CONDITIONS

Full perimeter assessment of existing masonry veneer needs to be performed. Areas to examine include:

- a. Mortar joints failing, specifically areas at Kindergarten.
- b. Failing soft joints at expansion joints and window perimeters.
- c. Masonry weeps
 - Positioning of the weeps is inconsistent around the building perimeter. Weeps at base of the wall vary from 24 inches on center to 72 inches on center. Weeps at window sills are included at some windows or are completely absent at other windows.
 - The cell venting products at the weep points are polypropylene and have deteriorated. They no longer serve the purpose of preventing insect access.

RECOMMENDATIONS

- a. Conduct full building survey and repoint mortar as necessary matching existing mortar in type and strength.
- b. Remove and replace all soft caulk joints providing backer rods when necessary.
- c. Short of removal and replacement of full masonry veneer, effective weeps cannot be installed afterwards. Failing vents should be replaced from the exterior and be tight to both side of brick ends.

Notes on Costing: Given that the scope of this work may vary, the exact cost provided in the back-up may change depending on verified field conditions. See notes regarding allowances and assumptions.



a. Open Mortar joints



b. Failing soft joints

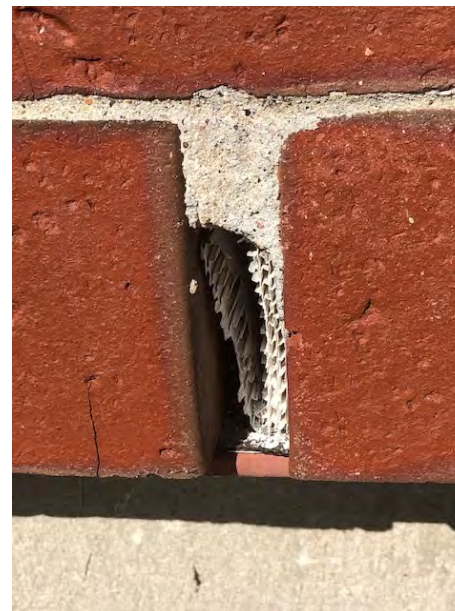

c. Failing masonry weeps

Life Safety and Egress Requirements

RELATED SCOPES OF WORK
EM-ALL-E-3019

EM-G-LS-3053				
Priority	Cost			
	\$\$			
Coordination by Discipline				
<input checked="" type="checkbox"/>	<input checked="" type="checkbox"/>	<input checked="" type="checkbox"/>	<input checked="" type="checkbox"/>	<input checked="" type="checkbox"/>
A	M	E	P	FP
<input type="checkbox"/>	<input checked="" type="checkbox"/>	<input type="checkbox"/>	<input checked="" type="checkbox"/>	<input type="checkbox"/>
S	LS	SC	BE	C

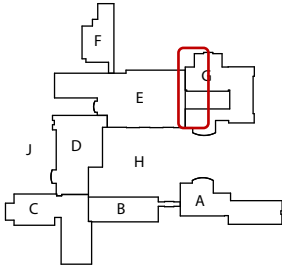

EXISTING CONDITIONS

- With the 1994 addition / renovation work, the floor plan oriented new corridors to align with the existing 3-story stairwells in the 1934 building. The east stairwell exits into a code-compliant, protected corridor which exits to the exterior. The west stairwell, however, exits through an exit access corridor.

This condition is not compliant with life safety code. The stair must either egress directly to the exterior, or to a protected egress corridor. Occupants cannot enter a protected stairwell and then leave into an unprotected corridor, before exiting outside.

In addition, there are other violations of life safety and building code:

- Doors have been removed from the stairwell. Stairs are a protected means of egress and must have doors to protect from smoke/fire spread. This applies to only the west stairwell.
- Following renovations, a number of items remained in the stairwell that either diminish egress travel widths or are non-ansi-compliant (drinking fountain). This applies to both east and west stairwells.
- Penetrations through the stair walls are often not sealed and/or fire-caulked affecting the integrity of the stair separation. This applies to both east and west stairwells.

RECOMMENDATIONS

- See plan diagram on following page.
- Reinstall rated doors at entrances on each level to stairwell.
- Remove and/or relocate items that are non-compliant and/or diminish egress width.
- Fire-caulk / seal penetrations through stair walls.

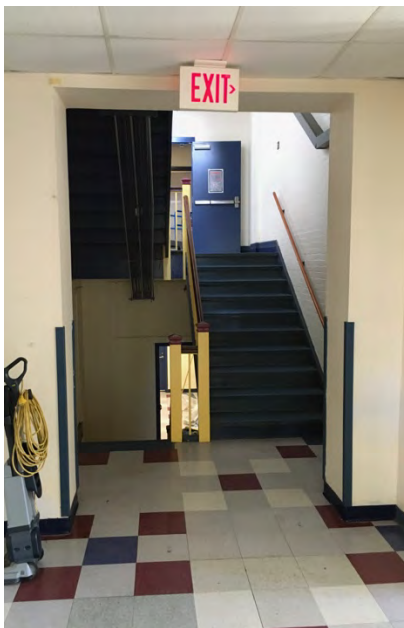

Reinstall rated doors at entrances on each level.



Remove drinking fountain, cap plumbing, relocate ladder.



Penetration through stair wall not sealed.

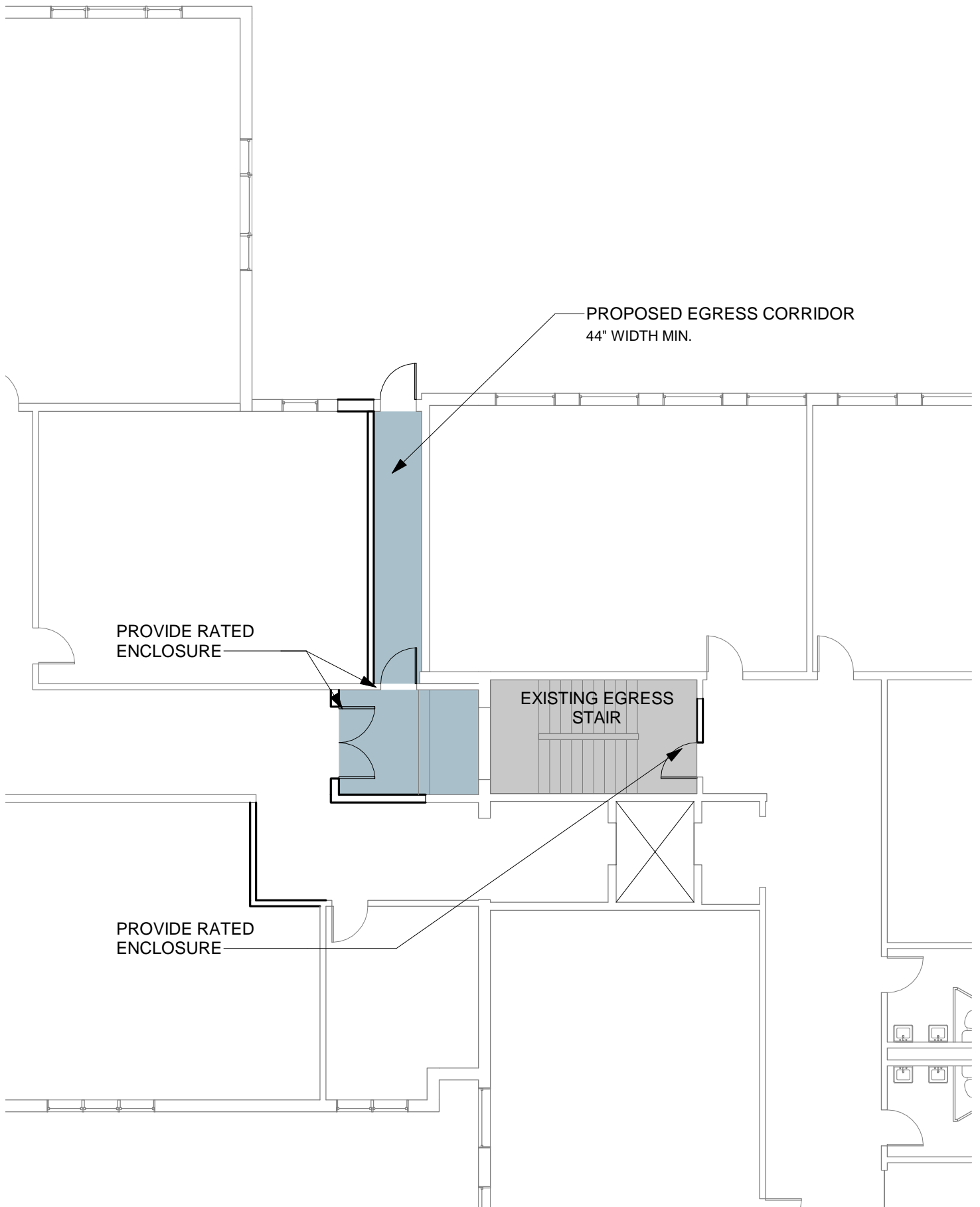

Firestop Wall and Floor Penetrations

Penetrations by utilities, and other openings in rated assemblies

RELATED SCOPES OF WORK

EM-ALL-LS-3001

EM-ALL-FP-3054					
Priority	Cost				
	\$\$				
Coordination by Discipline					
<input checked="" type="checkbox"/>	<input checked="" type="checkbox"/>		<input checked="" type="checkbox"/>	<input checked="" type="checkbox"/>	<input checked="" type="checkbox"/>
A	M		E	P	FP
<input checked="" type="checkbox"/>	<input checked="" type="checkbox"/>	<input type="checkbox"/>	<input type="checkbox"/>	<input type="checkbox"/>	
S	LS	SC	BE	C	

EXISTING CONDITIONS

Many walls and floors throughout the building are penetrated by various building systems including, but not limited to, fire protection piping, plumbing systems, HVAC systems, and electrical conduit. Many of these penetrations are not sufficiently firestopped to meet the rating of the assembly being penetrated. Several penetrations are currently firestopped, but insufficiently. There are also several empty openings through walls and floors where building systems once penetrated, but have since been removed.



RECOMMENDATIONS

Provide firestopping to meet the rating of the building assembly being penetrated, throughout building.

SCOPE OF WORK

Provide architectural and engineering services to determine the locations of fire and smoke rated building assemblies, and to determine the type of firestop system suitable at each type of penetration. Provide firestopping for existing building systems that will remain. Provide firestopping for openings which are empty due to removal of building systems or other reasons. Provide firestopping for new building systems once in place.

Replace Roof Drains

Retrofit-type drains restrict flow area
 Replace when roof repairs are made

RELATED SCOPES OF WORK

Not Applicable

EM-ALL-P-3055				
Priority		Cost		
		\$		
Coordination by Discipline				
<input checked="" type="checkbox"/>	<input checked="" type="checkbox"/>	<input type="checkbox"/>	<input checked="" type="checkbox"/>	<input type="checkbox"/>
A	M	E	P	FP
<input type="checkbox"/>	<input type="checkbox"/>	<input type="checkbox"/>	<input type="checkbox"/>	<input type="checkbox"/>
S	LS	SC	BE	C

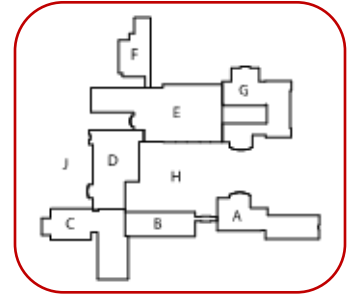

EXISTING CONDITIONS

Some of the existing roof drains are a retrofit type typically installed by roofing contractors when they are replacing roof membranes and adding insulation. These generally differ from the retrofit drains used at the High School, but similarly have a flat top plate and a flashing tube that inserts through the existing drain bowl and into the pipe, as well as a low-cost plastic basket that doesn't hold in place well. Roofers also often allow the roof membrane to overlap the drain opening, also restricting water flow, such as the drain on the new boiler room roof.



RECOMMENDATIONS

When performing roofing repairs or replacement, adding of roof insulation thickness, or HVAC equipment replacement, replace the roof drains. Provide full replacement of the existing original drain body at the roof structural deck level, as well as the retrofit drain at the roof surface. Avoid using the retrofit drains, which do not perform the same as a true roof drain.

NEXT LEVEL

Provide secondary drainage systems if the roof structure cannot support standing water.

SCOPE OF WORK

Base Level: Remove existing original roof drain body, retrofit roof drain, and piping as necessary. Provide roof drains with cast iron bodies, deck clamps and other accessories, and aluminum or plastic strainer domes. Extend piping to the drain outlet connections. Insulate drain bodies and piping below the roof

Next Level: Provide architectural and engineering services to determine the adequacy of the roof structure to support standing water if a roof drain or piping is clogged. Base the design on current structural and plumbing codes. Provide secondary drainage system as required by Code if roof cannot support the water.

Window Sealing & Operability Issues

RELATED SCOPES OF WORK

- E-ROOF-M-1014
- E-ROOF-M-1015
- E-ROOF-M-1021
- E-ROOF-M-1022
- E-ROOF-M-1026

EM-ALL-A-3056				
Priority	Cost			
	\$\$\$\$			
Coordination by Discipline				
<input checked="" type="checkbox"/>	<input checked="" type="checkbox"/>	<input type="checkbox"/>	<input type="checkbox"/>	<input type="checkbox"/>
A	M	E	P	FP
<input type="checkbox"/>	<input type="checkbox"/>	<input type="checkbox"/>	<input checked="" type="checkbox"/>	<input type="checkbox"/>
S	LS	SC	BE	C

EXISTING CONDITIONS

- a. Seals are failing on aging insulated glass units such as the window units in Room 122 resulting in poor thermal performance and internal condensation. Expected service life of most insulated glass units is about 25 years. Most units are approaching the end of expected service.
- b. Fixed window units are in applications where occupants would benefit from operable window units.
- c. Operable windows are positioned next to rooftop exhaust units.

RECOMMENDATIONS

- a. Survey all exterior windows for signs of seal failure. Rather than replacing glazing alone, full window unit replacement should be considered. New units could incorporate a better performing thermally broken frame.
- b. During window replacement process described below fixed units should be replaced with operable units.
- c. All operable window units should be a minimum of ten feet from a mechanical exhaust hood. Existing operable units within ten feet should be fixed mechanically to prevent opening.

SCOPE OF WORK

The Pond Cove Elementary and CE Middle School buildings include over 690 individual window units primarily varying in age from 15 years to 27 years. Window replacements should be considered for each school wing starting with the wing with most window failures as determined by the survey.



Operable window unit within ten feet of exhaust hood

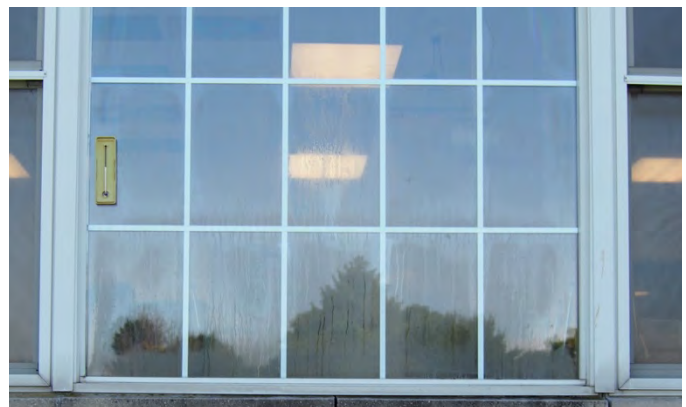

Compromised glazing seal

Ligature Resistant Restroom Fixtures

RELATED SCOPES OF WORK

H-ALL-P-4100

H-B246-A-4001	
Priority	Cost
	\$
Coordination by Discipline	
<input checked="" type="checkbox"/>	<input type="checkbox"/>
<input type="checkbox"/>	<input checked="" type="checkbox"/>
<input type="checkbox"/>	<input type="checkbox"/>
<input type="checkbox"/>	<input type="checkbox"/>
<input type="checkbox"/>	<input type="checkbox"/>
S	C

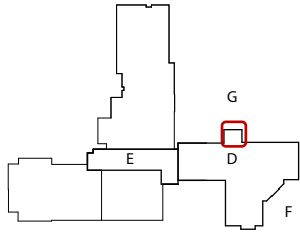

EXISTING CONDITIONS

Existing toilet accessories in Toilet Room B246 within in Special Education / Life Skills space, furnishings and plumbing fixtures are non-ligature resistant and pose a threat to occupants who may be emotionally unstable.

RECOMMENDATIONS

Provide a complete suite of ligature resistant toilet accessories and plumbing fixtures within this space. These must also be ADA compliant.

NEXT LEVEL

Review all Special Education and Life Skills spaces and remove all non-ligature resistant items. We recommend a secure closet be provided to relocate necessary items that should not be left in the space.

SCOPE OF WORK

Toilet Accessories:

- Mirror
- Toilet Paper Holder
- Paper Towel Holder
- Trash Receptacle

Plumbing Fixtures

- Toilet
- Lavatory

Cafeteria Kitchen Improvements

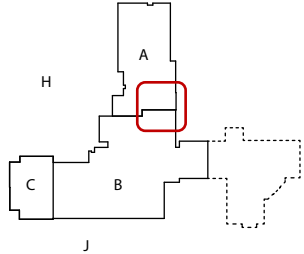
H-A126-A-4002				
Priority	Cost			
	TBD			
Coordination by Discipline				
<input checked="" type="checkbox"/>	<input checked="" type="checkbox"/>	<input checked="" type="checkbox"/>	<input checked="" type="checkbox"/>	<input checked="" type="checkbox"/>
A	M	E	P	FP
<input type="checkbox"/>	<input checked="" type="checkbox"/>	<input type="checkbox"/>	<input type="checkbox"/>	<input type="checkbox"/>
S	LS	SC	BE	C

RELATED SCOPES OF WORK

- H-A123-A-4015
- H-A126-P-4111
- H-A126-P-4112

EXISTING CONDITIONS

During stakeholder interviews and subsequent field visits, some issues with the HS kitchen were noted, including:

- a. The existing kitchen is too small to properly prepare and serve the number of meals and variety required by state standards.
- b. There is a lack of appropriate storage, resulting in items being stored in the open.
- c. Laundry facilities are located in the kitchen and not separated.
- d. The dishwashing area is too small.
- e. The existing tile floor is difficult to maintain and clean.

RECOMMENDATIONS

- a. Coordinate with Work Item H-A123-A-4015. If renovations are pursued within the cafeteria (which is underutilized currently), there may be an opportunity to expand the kitchen during this renovation work.
- b. Coordinate with Work Item H-A123-A-4015. If renovations are pursued, storage space should be included in the programming effort. This includes separate storage for cleaning supplies and dry goods (if needed).
- c. Coordinate with Work Item H-A123-A-4015. If renovations are pursued, it may be possible to relocate the laundry facilities so they are nearby but not within the kitchen itself.
- d. Per (c) above, if the laundry facilities are relocated, the dishwashing line can be extended.
- e. Consider installation of flooring over the existing tile. Prioritize seamless, antimicrobial flooring such as epoxy and sheet vinyl.

Notes on Costing: Given that the scope of this work may vary greatly, please see costing sheet and associated back-up for relevant unit pricing.



Laundry facilities are located at end of dishwashing line.



Lack of proper storage results in cleaning supplies stored in corridor.



Dishwashing area is undersized.

Acoustical Issues: Guidance Suite

RELATED SCOPES OF WORK
H-D-A-4024

H-D-A-4005	
Priority	Cost
	\$
Coordination by Discipline	
<input checked="" type="checkbox"/>	<input checked="" type="checkbox"/> <input type="checkbox"/> <input type="checkbox"/> <input type="checkbox"/>
A	M E P FP
<input type="checkbox"/>	<input type="checkbox"/> <input type="checkbox"/> <input type="checkbox"/> <input type="checkbox"/> <input type="checkbox"/>
S	LS SC BE C

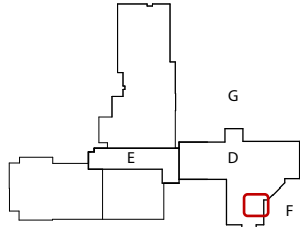

EXISTING CONDITIONS

Acoustical privacy issues have been reported in the existing Guidance Counselor Suite, specifically between some offices, the conference room, and general open area. This is a particular concern in this location due to the confidential nature of conversations held. Where observations were made (above the ceiling in room B343), partitions appeared to continue to the deck above. Thru-wall penetrations, however, did not appear to be sealed and likely contribute to noise transfer. It's possible that the layout of the mechanical ducts themselves also contribute to noise transfer, but this was not observed directly.



RECOMMENDATIONS

- a. Verify partitions extend to underside of deck in the balance of locations. If they do not, extend them. Review thru-wall penetrations and seal any openings present.
- b. Install acoustically lined z-shaped or u-shaped ducts where air transfer between spaces is required. Install such that STC rating matches that of the wall between the two spaces. Install acoustically lined duct for several feet

Cape Elizabeth Schools Needs Assessment

near each supply diffuser and return grille, to minimize sound transfer between spaces. Seal wall openings at duct penetrations.

NEXT LEVEL

Alter mechanical runs to reduce sound transfer. Relocate supply diffusers and return grilles to maintain maximum distance between the duct terminations of adjacent rooms. Include acoustically lined ductwork as indicated above. Coordinate with potential renovation of Guidance Suite per work item above as well as upgrades to the mechanical system.

SCOPE OF WORK

Scope of work to be determined based on field conditions and potential funding of related improvements.

Occupied Space without Exterior Window

RELATED SCOPES OF WORK

Not Applicable

H-ALL-A-4006				
Priority		Cost		
		\$		
Coordination by Discipline				
<input checked="" type="checkbox"/>	<input checked="" type="checkbox"/>	<input type="checkbox"/>	<input type="checkbox"/>	<input type="checkbox"/>
A	M	E	P	FP
<input checked="" type="checkbox"/>	<input type="checkbox"/>	<input type="checkbox"/>	<input checked="" type="checkbox"/>	<input type="checkbox"/>
S	LS	SC	BE	C

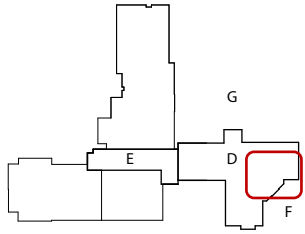

EXISTING CONDITIONS

It was noted frequently in stakeholder interviews that many offices and meeting rooms do not have windows. In some locations, these spaces have taken space previously utilized for another purpose and they are located in the interior of the building where exterior windows are not possible.

RECOMMENDATIONS

If building expansion is pursued as part of another Work Item and program is reallocated accordingly, it may be possible to move some of these offices to locations on exterior walls.

Considerations when adding windows to an existing exterior wall, include:

- a. Structural modifications (lintels) to support the façade above the new window. Hire a structural engineer to analyze and design temporary shoring and replace lintels.
- b. Building envelope modifications (flashing, air and water tightness, etc.)
- c. Additional solar heat gain during the summer and energy loss during winter. Spaces may need additional heating when a window is added.
- d. Aesthetics. Adding windows to the existing façade will have a visual impact that should be considered when selecting the type of window.

Wall Extension: Acoustical Improvements

RELATED SCOPES OF WORK

Not Applicable

H-ALL-A-4007	
Priority	Cost
	\$\$
Coordination by Discipline	
<input checked="" type="checkbox"/>	<input checked="" type="checkbox"/>
<input checked="" type="checkbox"/>	<input checked="" type="checkbox"/>
<input checked="" type="checkbox"/>	<input checked="" type="checkbox"/>
<input checked="" type="checkbox"/>	<input checked="" type="checkbox"/>
<input checked="" type="checkbox"/>	<input checked="" type="checkbox"/>
A	M
E	P
FP	
<input type="checkbox"/>	<input type="checkbox"/>
<input type="checkbox"/>	<input type="checkbox"/>
<input type="checkbox"/>	<input type="checkbox"/>
<input type="checkbox"/>	<input type="checkbox"/>
S	LS
SC	BE
C	

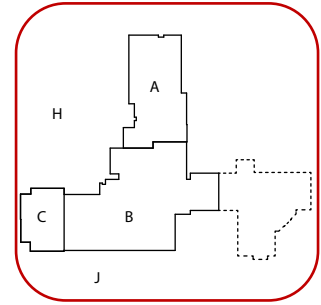

EXISTING CONDITIONS

Several walls do not extend to deck between classrooms and compromise the acoustical comfort of the adjacent spaces. The following rooms were observed to have a continuous plenum space:

- a. 306, 305, 304, 302
- b. 317A, 318, 319, 320, 321
- c. 217, 216, 215, 214, 213, 212, 211, JC
- d. 206, 207

Please note that locations were spot checked within each building wing. This list may not be an exhaustive list of all locations.

RECOMMENDATIONS

- Contractor to review locations where acoustical separation is recommended and verify wall conditions in those locations.
- Wall to be extended to deck in locations where separation is not currently provided.
- Where walls are to be continued to deck, coordinate all work with mechanical systems to ensure air supply and ventilation requirements are met. Also coordinate penetrations required for any electrical, plumbing and sprinkler piping penetrations. See work items noted above.

Notes on Costing: Given that the scope of this work may vary, the exact cost provided in the back-up may change depending on verified field conditions.

General Appearance & Finishes

RELATED SCOPES OF WORK

H-ALL-A-4032
H-A-A-4021

H-ALL-A-4009				
Priority	Cost			
	\$\$\$\$			
Coordination by Discipline				
<input checked="" type="checkbox"/>	<input type="checkbox"/>	<input checked="" type="checkbox"/>	<input type="checkbox"/>	<input type="checkbox"/>
A	M	E	P	FP
<input type="checkbox"/>	<input type="checkbox"/>	<input type="checkbox"/>	<input type="checkbox"/>	<input type="checkbox"/>
S	LS	SC	BE	C

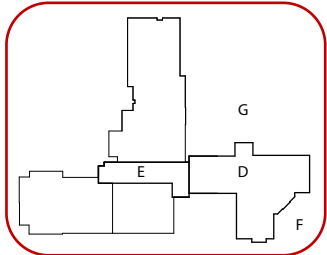

EXISTING CONDITIONS

In the stakeholder interviews, one of the consistent themes voiced by teachers and administration was a concern about the overall aesthetic of the school – finishes and fixtures are worn, dated, and/or require an extensive amount of maintenance. The buildings are well-maintained by the facilities department, but some finishes are well past their typical service life. Repairing and/or replacing millwork, along with new finishes where appropriate (replacement of Vinyl Composition Tile, VCT, with flooring that requires substantially lower maintenance, for example), will lower maintenance costs, but also contribute to a pride of ownership. Increased access to daylight, where possible, has also proven effective.

RECOMMENDATIONS

Flooring:

- Consider replacement of worn, dated, and/or maintenance-heavy flooring, such as VCT. One possible replacement is Luxury Vinyl Tile (LVT) which does not require the annual stripping, waxing, and sealing required by VCT. Recommended course of action is to replace one area at a time. With each area, a ROI calculation can be made to determine expected payback based on maintenance and life cycle costs.
- Another example is the brick paving at the corridors on the lower level which is difficult to maintain. Alternate flooring options for this location could include quartz tile, or terrazzo. Terrazzo is utilized in high-traffic applications world-wide and has a life expectancy that could surpass the building.
- At wet locations, consider replacement of the existing tile floor with a watertight, seamless solution. This both reduces maintenance and is more hygienic.

Ceilings:

- Often the ACT ceilings are worn and damaged (water spots, discolored, etc.). New ACT ceilings in areas where they are appropriate would provide a refresh which, coupled with lighting updates, could re-invigorate some spaces.
- In common areas where above-ceiling access is still necessary, consider a modular, linear wood ceiling. This would provide significant warmth to corridors, along with the benefits of exposure to natural materials.
- Update lighting to LED fixtures, thereby reducing energy costs while providing benefits of lighting with a more appropriate color temperature, which has been proven to have an effect on student learning.

Millwork:

- Repair and refinish millwork as required. Note areas where the millwork could better suit its current use and update accordingly.

SCOPE OF WORK

Identify areas of finishes to be replaced or refurbished. Consult with an A/E team to determine other considerations (for example, replacement flooring that is thicker than the current flooring could have other ramifications such as added thresholds, work at door bottoms, etc). Schedule replacement as funding permits. If other Work Items constitute a large renovation in a particular area, consider whether finish upgrades can happen simultaneously.

Notes on Costing: Costing for this item does not include flooring upgrades, see H-ALL-A-4032. Given that the scope of this work may vary, the exact cost provided in the back-up may change depending on verified field conditions.

Cape Elizabeth Schools Needs Assessment

Exposed Piping

H-318-A-4010				
Priority	Cost			
	\$			
Coordination by Discipline				
<input checked="" type="checkbox"/>	<input checked="" type="checkbox"/>	<input type="checkbox"/>	<input checked="" type="checkbox"/>	<input type="checkbox"/>
A	M	E	P	FP
<input type="checkbox"/>	<input type="checkbox"/>	<input type="checkbox"/>	<input type="checkbox"/>	<input type="checkbox"/>
S	LS	SC	BE	C

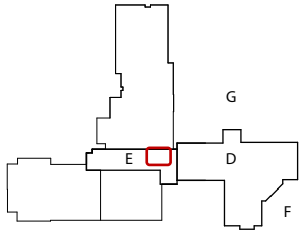

RELATED SCOPES OF WORK

Not Applicable

EXISTING CONDITIONS

Piping is exposed within classroom 318, leading to the adjacent Prep Room. The engineering team believes this to be a water line.



RECOMMENDATIONS

Confirm this is a water line. Enclose and protect from exposure within finished classroom space. Coordinate this work with any work items elected for replacement of mechanical equipment. See work items above.

Cape Elizabeth Schools Needs Assessment

**Widows:
Gasket Failure**

H-ALL-A-4011	
Priority	Cost
	\$\$
Coordination by Discipline	
<input checked="" type="checkbox"/>	<input type="checkbox"/>
<input type="checkbox"/>	<input type="checkbox"/>
<input type="checkbox"/>	<input type="checkbox"/>
<input type="checkbox"/>	<input type="checkbox"/>
<input type="checkbox"/>	<input type="checkbox"/>
A	M
E	P
FP	
S	LS
SC	BE
C	

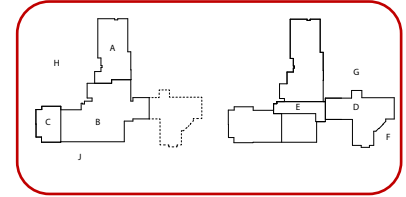

RELATED SCOPES OF WORK

Not Applicable

EXISTING CONDITIONS

Gaskets failing in IGU assemblies in several locations throughout building:

- Wood Lab (C111)
- Ensemble Room (C137)
- Stair 1 Landing
- 2nd Floor Classrooms (217,215,214,211)
- Entry Vestibule at Nurse's Office (3rd Floor)



RECOMMENDATIONS

Replace IGU assemblies where gaskets have failed. In coordination with current window replacement maintenance program, possibly prioritize those windows which have failing gasketing.

Conduit Penetrations at Corridor

RELATED SCOPES OF WORK
H-ALL-FP-4119

H-ALL-LS-4012				
Priority		Cost		
		\$\$		
Coordination by Discipline				
<input checked="" type="checkbox"/>	<input type="checkbox"/>	<input checked="" type="checkbox"/>	<input type="checkbox"/>	<input checked="" type="checkbox"/>
A	M	E	P	FP
<input type="checkbox"/>	<input checked="" type="checkbox"/>	<input type="checkbox"/>	<input type="checkbox"/>	<input type="checkbox"/>
S	LS	SC	BE	C

EXISTING CONDITIONS

- a. Sealant appears missing at some conduit penetrations above ACT ceiling or at floor conditions. In some locations, ceilings don't exist such as in Janitor's Closets. In some cases, this happens at corridor or storage room walls where smoke separation is required.

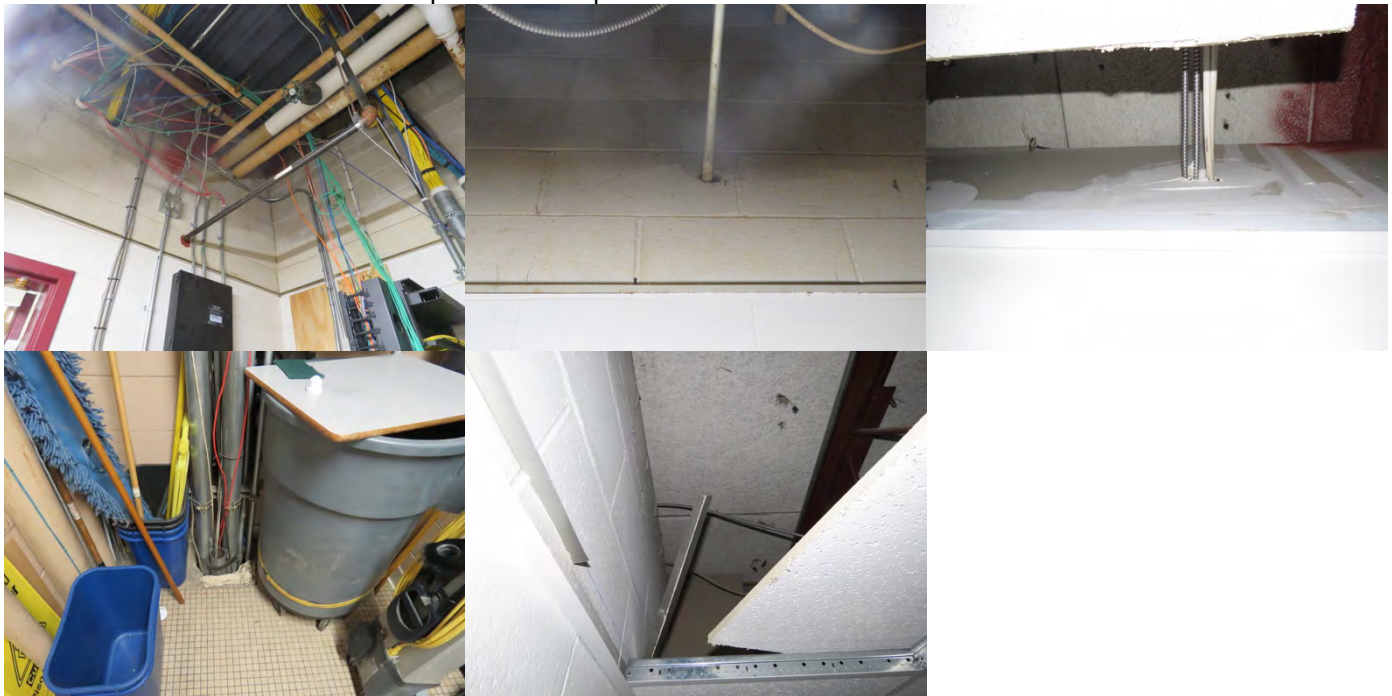

RECOMMENDATIONS

- a. Electrical contractor to survey all penetration locations and seal those where smoke separation is required. Where penetrations exist between classroom spaces, provide sealant to reduce noise transfer between classrooms. Where partitions do not currently go up to deck between spaces, or new electrical work is being done, coordinate penetrations with the work items listed above.

SCOPE OF WORK

- a. Full extent of work not known at this time. Electrical contractor to review and provide estimate.

Notes on Costing: Given that the scope of this work may vary, the exact cost provided in the back-up may change depending on verified field conditions.

Faculty Support Space: Mother's Room

RELATED SCOPES OF WORK

Not Applicable

H-NEW-A-4013				
Priority		Cost		
		\$		
Coordination by Discipline				
<input checked="" type="checkbox"/>	<input checked="" type="checkbox"/>	<input checked="" type="checkbox"/>	<input checked="" type="checkbox"/>	<input checked="" type="checkbox"/>
A	M	E	P	FP
<input type="checkbox"/>	<input checked="" type="checkbox"/>	<input type="checkbox"/>	<input type="checkbox"/>	<input type="checkbox"/>
S	LS	SC	BE	C

EXISTING CONDITIONS

This space does not currently exist in a dedicated fashion. This need has sometimes been met in borrowed use of the Concessions Stand.

RECOMMENDATIONS

Provide a faculty support space for nursing mothers. Include a private pumping area with sink and refrigerator for privacy and security.

Life Skills Room Improvements

RELATED SCOPES OF WORK

H-202-M-4065
H-ALL-E-4048

H-202-A-4014				
Priority		Cost		
		\$		
Coordination by Discipline				
<input checked="" type="checkbox"/>	<input checked="" type="checkbox"/>	<input checked="" type="checkbox"/>	<input type="checkbox"/>	<input type="checkbox"/>
A	M	E	P	FP
<input type="checkbox"/>	<input type="checkbox"/>	<input type="checkbox"/>	<input checked="" type="checkbox"/>	<input type="checkbox"/>
S	LS	SC	BE	C

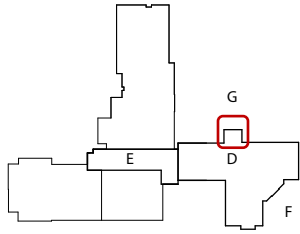

EXISTING CONDITIONS

The Life Skills Room 202 has a full kitchen with a range hood and washer and dryer. Necessary improvements include:

- a. Better regulation of temperature control.
- b. Updated lighting with a warmer color temperature.
- c. Installation of a mechanical system that can provide cooling for summer programs.
- d. Installation of a damper on the range hood to prevent air infiltration when not in use.

RECOMMENDATIONS

- a. Consult with an A/E team to design and implement a heating and cooling system to better regulate temperature.
- b. Update lighting.
- c. See (a) above.
- d. Install a damper on the range hood exhaust.

Cape Elizabeth Schools Needs Assessment

Cafeteria Changes: Alternative Seating. Space Inefficiencies

RELATED SCOPES OF WORK

H-A126-A-4002
H-NEW-A-4031

H-A123-A-4015				
Priority	Cost			
	\$\$\$			
Coordination by Discipline				
<input checked="" type="checkbox"/>	<input type="checkbox"/>	<input type="checkbox"/>	<input type="checkbox"/>	<input type="checkbox"/>
A	M	E	P	FP
<input type="checkbox"/>	<input type="checkbox"/>	<input type="checkbox"/>	<input type="checkbox"/>	<input type="checkbox"/>
S	LS	SC	BE	C

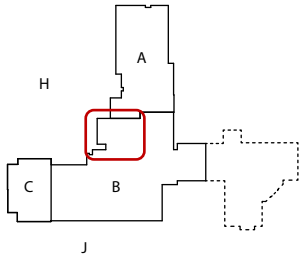

EXISTING CONDITIONS

- a. The rear portion of the cafeteria is largely unused. A small portion of it is reserved for senior seating, although with senior off-campus lunch privileges, it is underutilized. Another portion is completely empty.
- b. The only table choice is a circular table which seats 8. This results in many students finding alternate locations to sit, including the corridors.
- c. There are many hard surfaces and the space is acoustically very loud.

RECOMMENDATIONS

- a. During stakeholder interviews, one possible use of this space as the new hub space was discussed (see Work Item H-NEW-A-4031).
- b. Create areas for seating that create smaller arrangements and choices for students to form smaller groups.
- c. Install acoustic wall treatment to dampen the volume.



Mostly unused space to the left of the egress doors.



Space reserved for senior seating behind temporary partitions.

Gender Neutral Restrooms

H-ALL-A-4016	
Priority	Cost
	\$\$
Coordination by Discipline	
<input checked="" type="checkbox"/>	<input checked="" type="checkbox"/> <input type="checkbox"/> <input checked="" type="checkbox"/> <input type="checkbox"/>
A	M E P FP
<input type="checkbox"/>	<input type="checkbox"/> <input type="checkbox"/> <input type="checkbox"/> <input type="checkbox"/> <input type="checkbox"/>
S	LS SC BE C

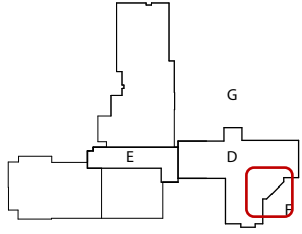

RELATED SCOPES OF WORK

Not Applicable

EXISTING CONDITIONS

Rooms B332 and B338 are existing unisex restrooms that are ADA compliant, but have excessive floor area per fixture.

- Ventilation is reportedly inadequate in B332.
- B338 door hardware should allow the door to be locked; An occupancy sign is used to indicate use.
- These are currently labeled for use by faculty only



RECOMMENDATIONS

- Replace door hardware on both doors to allow for locking from interior for privacy, but allow for override from outside for security and oversight. Supervision protocol will have to be updated to reflect change in operation.
- One or both restrooms could be re-established as gender neutral restrooms, revise signage accordingly
- One or both restrooms could be made available for student use as well, revise signage accordingly

NEXT LEVEL

- If additional plumbing fixture counts are needed, one or both of these restrooms could be renovated to provide two individual water closet compartments with a shared sink. In this case, the door to the corridor would require locking only as needed for maintenance and operations.

SCOPE OF WORK

Base recommendations include new door hardware and new room signage as indicated above. A general plan diagram has been included for reference describing next level work. The design team recommends working with an architect / engineering team to explore options for reconfiguring the space and incorporating the goals listed above. Mechanical work may be required to ensure proper ventilation and supply.

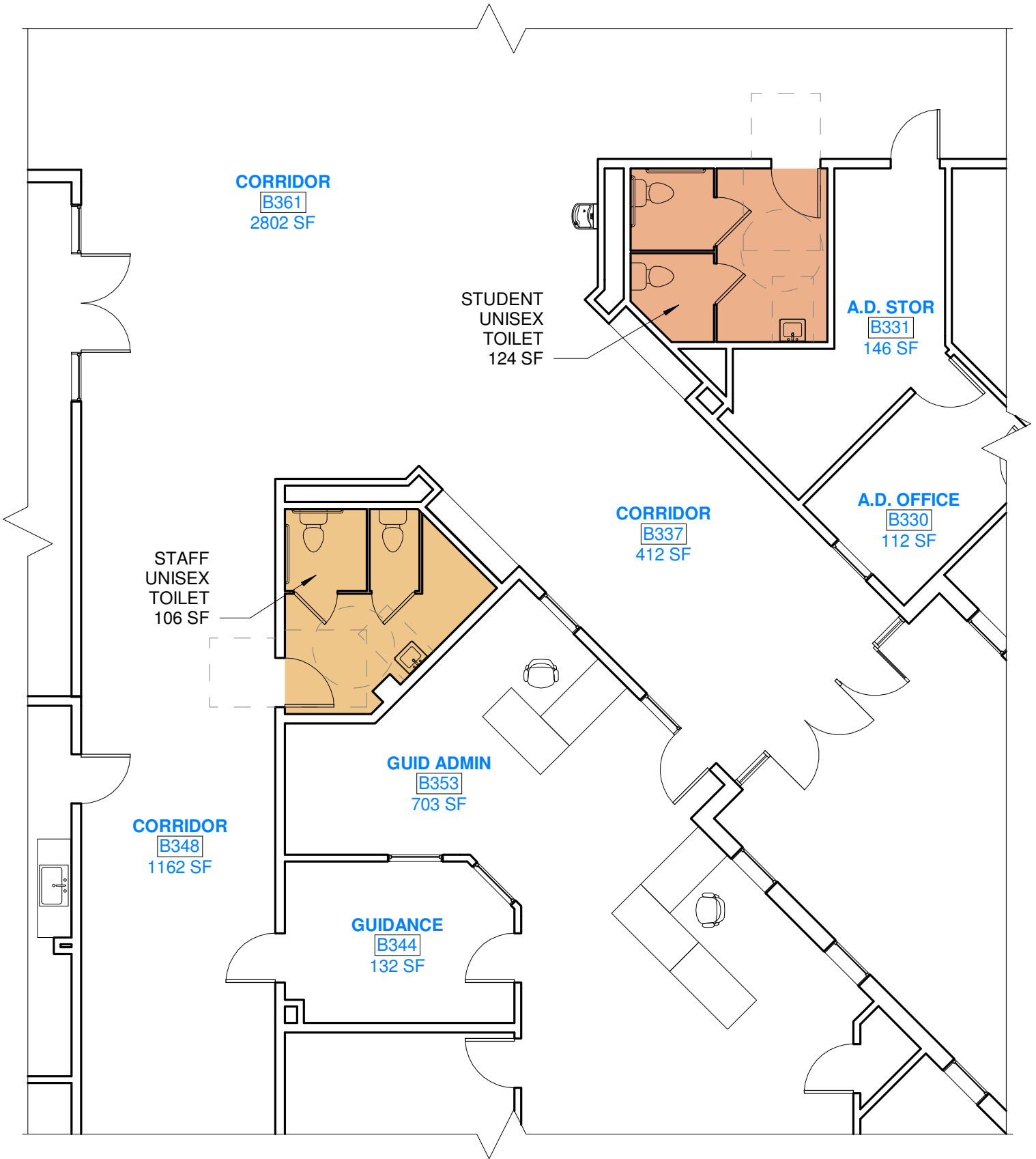

Door Compliance Issues

H-ALL-A-4017	
Priority	Cost
	\$\$
Coordination by Discipline	
<input checked="" type="checkbox"/>	<input checked="" type="checkbox"/> <input type="checkbox"/> <input type="checkbox"/> <input type="checkbox"/>
A	M E P FP
<input type="checkbox"/>	<input checked="" type="checkbox"/> <input type="checkbox"/> <input type="checkbox"/> <input type="checkbox"/>
S	LS SC BE C

RELATED SCOPES OF WORK

H-ALL-LS-4052

EXISTING CONDITIONS

- a. Life Safety Code requires that doors onto egress corridors are equipped with closers to prevent the spread of smoke. Most classroom doors do not have closers installed.
- b. ADA Requirement: Vision lites in doors must start no higher than 43” above the floor. If there is more than one vision lite, only one needs to comply. Most of the doors which contain vision lites do not comply.
- c. ADA Requirement: Doors with closers must have clear width at the latch side of the door. On the pull side, the required width is 18”; on the push side 12”. Many doors throughout the facility do not comply.
- d. Transfer grilles through doors for transfer of exhaust make-up air is not allowed by Life Safety Code.

RECOMMENDATIONS

- a. Install closers on all corridor doors without closers. Where closers exist, confirm they are functioning (adjusted with the appropriate tension to close and latch the door).
- b. The design team recommends any new doors meet ADA requirements. Existing vision lites that are not ADA compliant should be upgraded as areas are renovated.
- c. Investigate if changes can be made to accommodate ADA clearance requirements.
- d. Coordinate with mechanical engineer to determine if door vent is part of active mechanical design.
 - If not, block door vents to prevent transfer of smoke in a life safety situation.
 - If so, block door vent. Install new transfer grille in wall with smoke damper tied to fire alarm system.

SCOPE OF WORK

In the short term, install closers on all corridor doors.

As areas are renovated consider addressing all door compliance issues within that area.

General ADA Compliance: Restrooms

RELATED SCOPES OF WORK
H-ALL-A-4016

H-ALL-A-4018				
Priority		Cost		
		\$		
Coordination by Discipline				
<input checked="" type="checkbox"/>	<input type="checkbox"/>	<input type="checkbox"/>	<input checked="" type="checkbox"/>	<input type="checkbox"/>
A	M	E	P	FP
<input type="checkbox"/>	<input type="checkbox"/>	<input type="checkbox"/>	<input type="checkbox"/>	<input type="checkbox"/>
S	LS	SC	BE	C

EXISTING CONDITIONS

- a. While many of the restrooms contain accessible stalls, the entryway into the restroom is not ADA compliant.
 ADA Requirement: Doors with closers must have clear width at the latch side of the door. On the pull side, the required width is 18"; on the push side 12".
 In some cases (C119, C122, A104, A106), door operators have been installed to rectify this condition.
- b. General mounting heights of paper towels dispensers and soap dispenser do not conform to ADA mounting heights.

RECOMMENDATIONS

- a. In many cases, adjacent construction will limit the ability to reasonably correct the door clearance issues. As such, the most feasible method to improve the condition is to continue to install door operators as funding permits. This cost has been carried as a unit cost within the costing back-up.
- b. Adjust mounting heights to conform with ADA mounting heights, ADA 604.9.

NEXT LEVEL

Coordinate with the effort to provide Gender Neutral Restrooms (Work Item H-ALL-A-4016). As portions of the school are renovated or expanded as part of other Work Items, upgrade restrooms in those areas to full ADA compliance during those renovations.

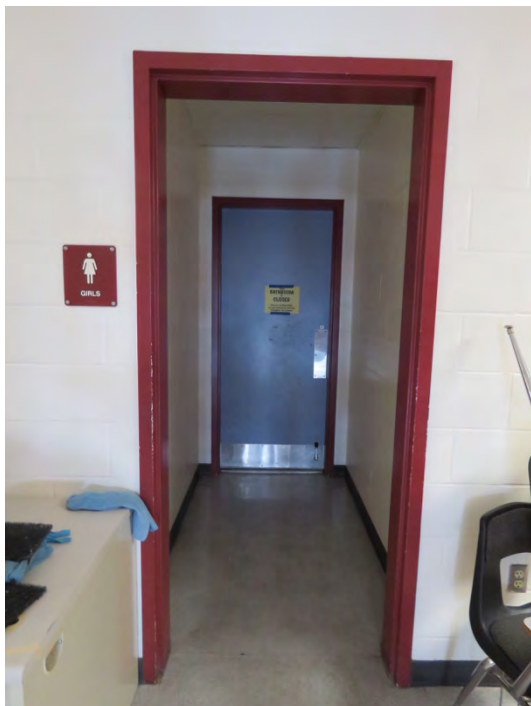

Non-compliant restroom entry.

Metal Shop Lift

H-C100-A-4019				
Priority	Cost			
	\$\$			
Coordination by Discipline				
<input checked="" type="checkbox"/> <input type="checkbox"/> <input checked="" type="checkbox"/> <input type="checkbox"/> <input type="checkbox"/>				
A	M	E	P	FP
<input checked="" type="checkbox"/>	<input type="checkbox"/>	<input type="checkbox"/>	<input type="checkbox"/>	<input type="checkbox"/>
S	LS	SC	BE	C

RELATED SCOPES OF WORK

Not Applicable

EXISTING CONDITIONS

The existing accessible lift in the Metal Shop (C100) is non-functioning and does not meet code. The metal shop is located on a lower floor plate, so the space is not accessible without a lift.



The notice on the lift reads:

This elevator fails to meet the standards set forth by the Board of Elevator and Tramway Safety, 32 M.R.S.A. 15206. -S. Quinn (Chief elevator inspector), date: 10/25/06

RECOMMENDATIONS

Install a new code-compliant lift.

Exterior Upgrades at Lower Entry

H-J-A-4020				
Priority	Cost			
	\$\$\$\$			
Coordination by Discipline				
<input checked="" type="checkbox"/>	<input type="checkbox"/>		<input checked="" type="checkbox"/>	<input type="checkbox"/>
A	M	E	P	FP
<input checked="" type="checkbox"/>	<input type="checkbox"/>	<input type="checkbox"/>	<input type="checkbox"/>	<input checked="" type="checkbox"/>
S	LS	SC	BE	C

RELATED SCOPES OF WORK

Not Applicable

EXISTING CONDITIONS

The existing pedestrian ramp that runs alongside the existing drive does not meet ADA requirements. The amphitheater-like space at the bottom of this hill, framed by the building on three sides, is an underutilized space.

RECOMMENDATIONS

- a. Determine the slope of the current ramp and re-grade/re-work ramp as required to assure ADA compliance (1:12 slope). Note that any slope greater than 5% (1:20) requires edge protection, handrails on both sides, and is limited to 30' between landings.

NEXT LEVEL

- b. With improvements, the space could serve as a performance / speaking location. See plan diagram. This solution proposes:
 - Creating terraces in the hillside for an amphitheater.
 - Installing low canopies for protection and to define the space.
 - Installing a high canopy on the stage side, which could be utilized for A/V support (speakers, lighting, etc).
 - Installing a high canopy above the entrance to better demarcate the entry location.

SCOPE OF WORK

At a minimum, an A/E team should be engaged to evaluate ADA-compliant ramp solutions and implement the preferred option. A Structural engineer should be engaged to design the canopy.

If funding is available, the terraced amphitheater improvements could be pursued.



Library and Adjacent Space Configuration

RELATED SCOPES OF WORK

- H-ALL-A-4009
- H-D-A-4027
- H-ALL-E-4046

H-A-A-4021				
Priority	Cost			
	\$\$			
Coordination by Discipline				
<input checked="" type="checkbox"/>	<input checked="" type="checkbox"/>	<input checked="" type="checkbox"/>	<input type="checkbox"/>	<input type="checkbox"/>
A	M	E	P	FP
<input type="checkbox"/>	<input type="checkbox"/>	<input type="checkbox"/>	<input type="checkbox"/>	<input type="checkbox"/>
S	LS	SC	BE	C

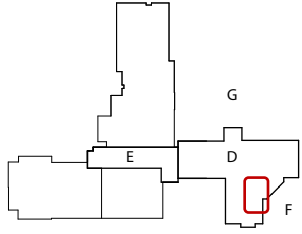

EXISTING CONDITIONS

Entry to the library is through a long corridor that also serves Special Ed classrooms and some offices. The entryway is not particularly welcoming, and the door/corridor layout make it difficult to secure the library independently from adjacent spaces served by the same corridor.

There are two green rooms used by students for film work located within the library footprint. While the location is good for monitoring by the librarian, there are some acoustic issues due to the proximity to the library stacks and reading space.

RECOMMENDATIONS

See plan diagram for one possible solution.

- a. Relocate corridor doors and one of the Special Ed classroom doors. This would enable the library to be secured independently from adjacent spaces.
- b. Consider re-purposing the two small green rooms for small group work space and outfitting some of the underutilized space in the vicinity as green room space. Coordinate with Work Item H-D-A-4027.
- c. Consider flooring and ceiling finish upgrades to create a warmer, more inviting entry corridor. Coordinate with Work Item H-ALL-A-4009.

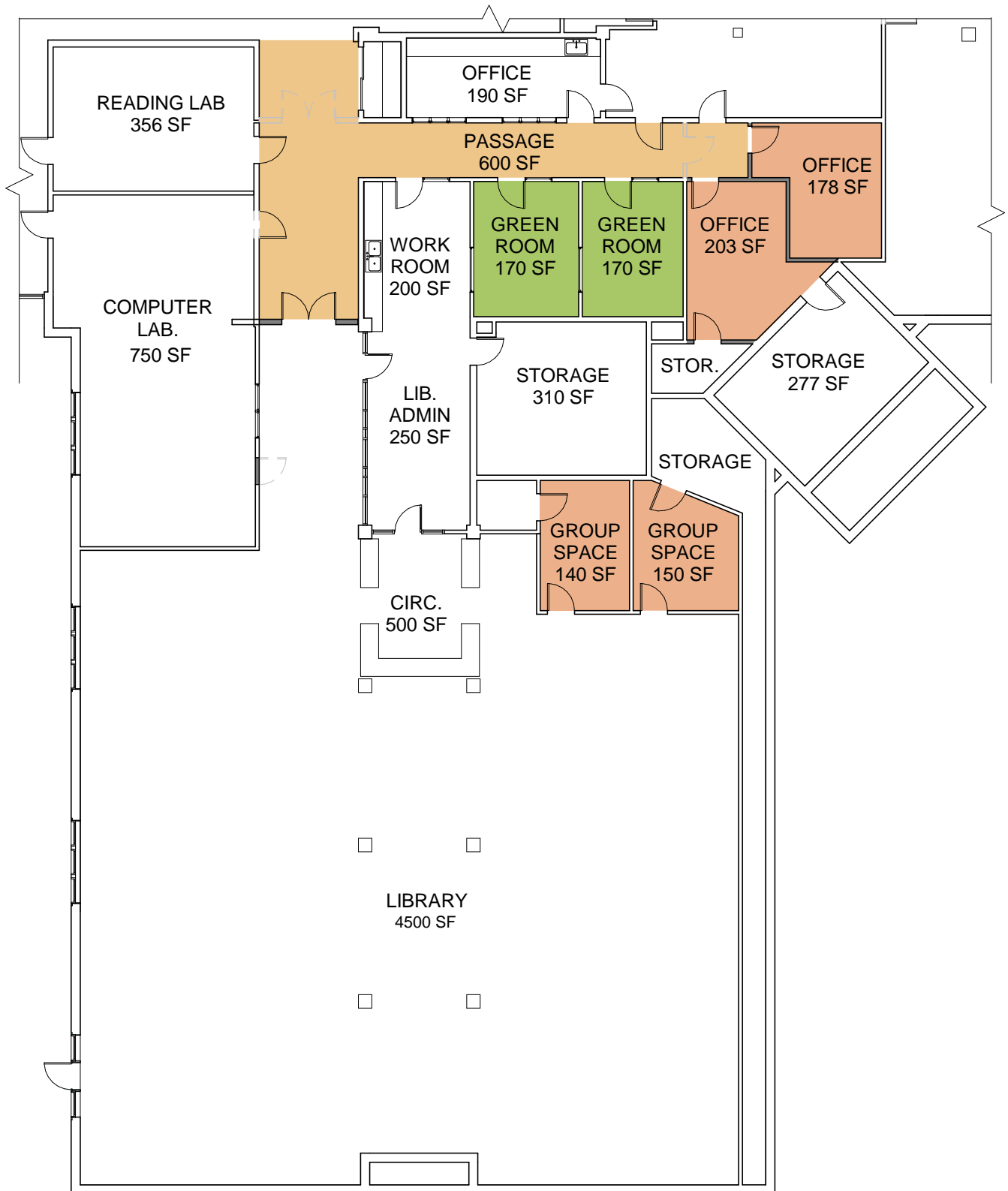

Programming Improvements and Expansion: Athletic

RELATED SCOPES OF WORK

- H-D-A-4023
- H-ALL-P-4103
- H-D114-M-4070

H-B-A-4022					
Priority	Cost				
	\$\$\$\$				
Coordination by Discipline					
<input checked="" type="checkbox"/>	<input checked="" type="checkbox"/>		<input checked="" type="checkbox"/>	<input checked="" type="checkbox"/>	<input checked="" type="checkbox"/>
A	M		E	P	FP
<input checked="" type="checkbox"/>	<input checked="" type="checkbox"/>	<input checked="" type="checkbox"/>	<input checked="" type="checkbox"/>	<input checked="" type="checkbox"/>	
S	LS	SC	BE	C	

EXISTING CONDITIONS

The existing athletic support spaces have the following challenges:

- The existing weight room is only 440sf, limiting use to only a few students at a time and creating potentially unsafe conditions.
- The athletics department has extremely limited space for storage – including items of high value that require dry, but not temperature-controlled storage.
- The locker room facilities meet ADA compliance but do not offer any gender-neutral facilities.
- Male and female facilities must be equalized to meet Title IX compliance.
- The corridor flooring (brick pavers) and locker room flooring (tile) hold dirt and require significant maintenance.

RECOMMENDATIONS

Weight room guidelines vary depending on how many students should be accommodated at one time. The design team proposes a reasonably sized weight-room between 1500sf and 2000sf. As there is no space in the existing footprint for a space this size, the design team recommends an addition to complement the athletic support facilities. The addition would consist of:

- New fitness room (1500sf – 2000sf).
- Multi-purpose classroom for yoga, dance, or similar instruction. Space may be able to double as alternative testing space which currently occupies the library for a portion of each academic year.
- Climate-controlled storage.
- Covered storage, without climate control, accessible from the field.
- A small meeting room for coaches / staff.

This addition would allow the existing weight room to be re-purposed as the new PT room; the existing PT room to be re-purposed as a gender-neutral facility. Finally, minor modifications to the boys and girls team locker areas will ensure Title IX compliance.

Although not currently included, offices for the Athletic Director and Assistant Athletic Director should be incorporated into this addition in coordination with item H-D-A-4023.

A diagrammatic layout is provided on the back-side of this sheet.

NEXT LEVEL

Funding permitting, the design team recommends new flooring that is more hygienic and requires less maintenance, and upgraded ceiling finishes to refresh the aesthetics of the lower level corridor and locker room spaces, while requiring less annual maintenance.

SCOPE OF WORK

See plan diagram on reverse side for scope of work.

- ADDITION TO HOUSE NEW FITNESS ROOM, MULTI-PURPOSE CLASSROOM, AND STORAGE SPACE
- EQUALIZE BOY'S AND GIRLS' TEAM LOCKERS
- PROVIDE GENDER-NEUTRAL FACILITIES
- REPLACE CORRIDOR AND LOCKER ROOM FLOORING WITH SEAMLESS MATERIAL REQUIRING LESS MAINTENANCE (TERRAZZO OR SIMILAR)
- OFFICES FOR THE ATHLETIC DIRECTOR AND ASSISTANT ATHLETIC DIRECTOR IN COORDINATION WITH ITEM H-D-A-4023.

PROPOSED	MENS	WOMENS	
boys shower	325 SF	771 SF	girls pool locker
boys locker	761 SF	68 SF	girls pool entry
boys pool locker	597 SF	43 SF	girls pool single rest.
boys team locker	705 SF	696 SF	girls locker room
PE office	140 SF	442 SF	PE office/coaches
men coaches	276 SF	385 SF	girls shower
pool entry - boys	90 SF	570 SF	girls team locker
	2894 SF	2975 SF	

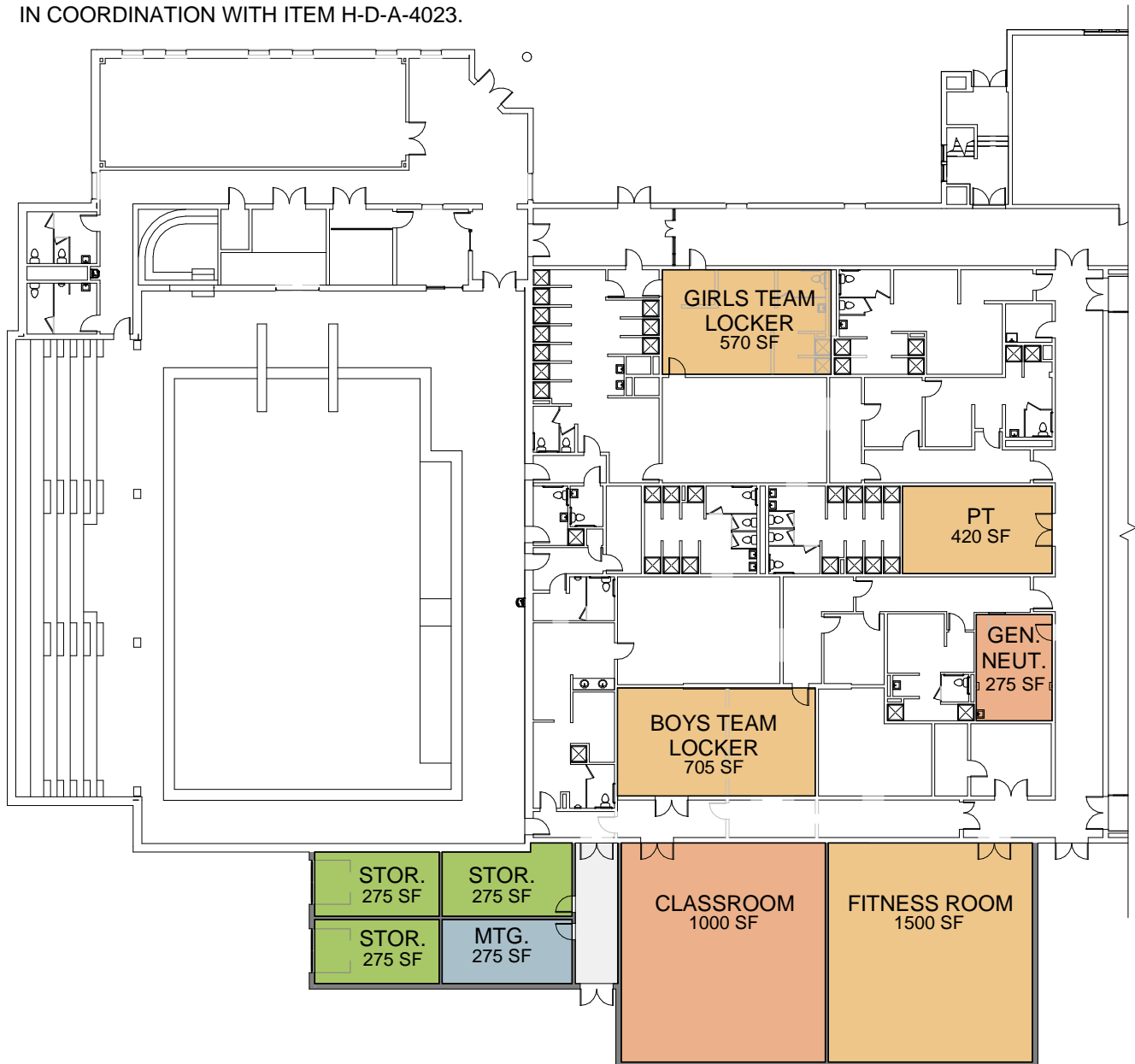

Improve School Resource Officer Proximity

RELATED SCOPES OF WORK

- H-NEW-A-4026
- H-B-A-4022
- H-NEW-A-4031

H-D-A-4023	
Priority	Cost
	\$
Coordination by Discipline	
<input checked="" type="checkbox"/>	<input checked="" type="checkbox"/>
<input checked="" type="checkbox"/>	<input checked="" type="checkbox"/>
<input checked="" type="checkbox"/>	<input type="checkbox"/>
<input checked="" type="checkbox"/>	<input checked="" type="checkbox"/>
A	M
E	P
FP	
<input checked="" type="checkbox"/>	<input type="checkbox"/>
<input type="checkbox"/>	<input type="checkbox"/>
<input type="checkbox"/>	<input type="checkbox"/>
<input type="checkbox"/>	<input type="checkbox"/>
S	LS
SC	BE
C	

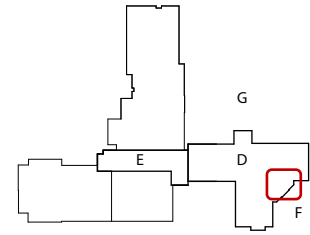

EXISTING CONDITIONS

The school has recently added a School Resource Officer (SRO). The current office is located on the first floor near the theater / gymnasium entrance.

RECOMMENDATIONS

Provide space for the SRO in the Main Office where there is proximity to school administration.

SCOPE OF WORK

See plan diagram for one possible solution. This solution proposes:

- a. Relocating offices for the athletic director and assistant athletic director as well as athletic department storage, perhaps as part of an athletic expansion (see Work Item H-B-A-4022).
- b. Reconfiguration of the space currently occupied with an office for the School Resource Officer and Transitional Classroom Space (see Work Item H-NEW-A-4026) for students with anxiety / attendance issues.
- c. Refer to detailed description of Extend Learning Coordinator on sheet H-NEW-A-4031.

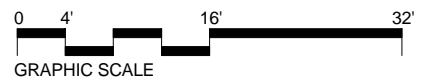
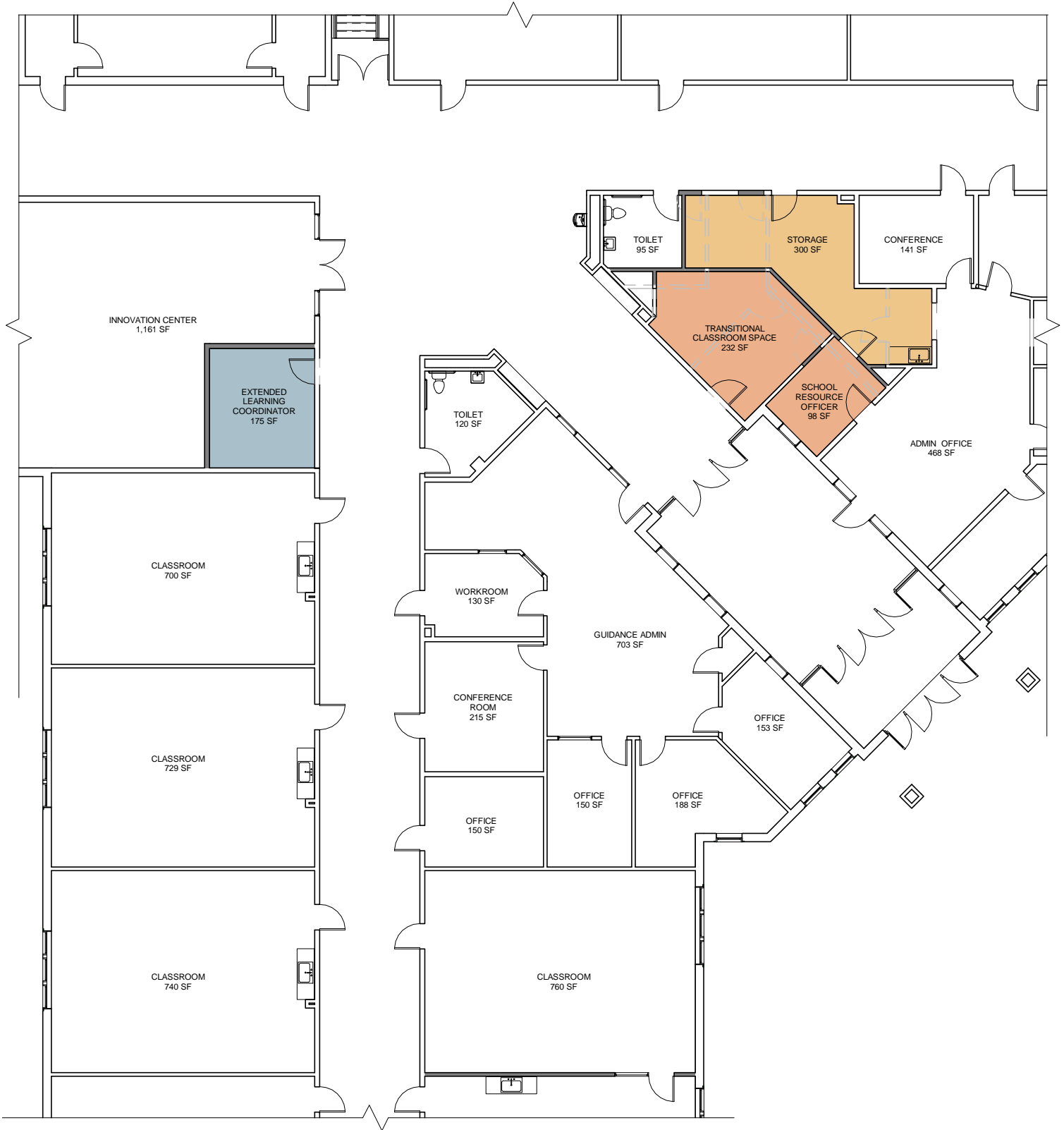

Cape Elizabeth Schools Needs Assessment

New Field House

H-NEW-A-4025				
Priority	Cost			
	\$\$\$\$			
Coordination by Discipline				
<input checked="" type="checkbox"/>	<input checked="" type="checkbox"/>		<input checked="" type="checkbox"/>	<input checked="" type="checkbox"/>
A	M	E	P	FP
<input checked="" type="checkbox"/>	<input checked="" type="checkbox"/>	<input checked="" type="checkbox"/>	<input checked="" type="checkbox"/>	<input checked="" type="checkbox"/>
S	LS	SC	BE	C

RELATED SCOPES OF WORK

H-NEW-A-4122

EXISTING CONDITIONS

Adjacent to Hannaford Field, there are no provisions for concessions (water, power, storage, etc), no permanent restrooms, and no covered storage for athletic equipment and supplies.

RECOMMENDATIONS

The design team recommends a field house consisting of:

- Ticketing area
- Concessions
- Restrooms (men, women, family)
- Janitor’s closet
- Storage
-

The design team recommends to begin scope of work with storage.

SCOPE OF WORK

See plan diagram below for a conceptual field house plan.

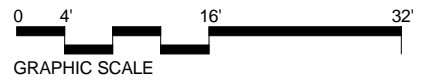
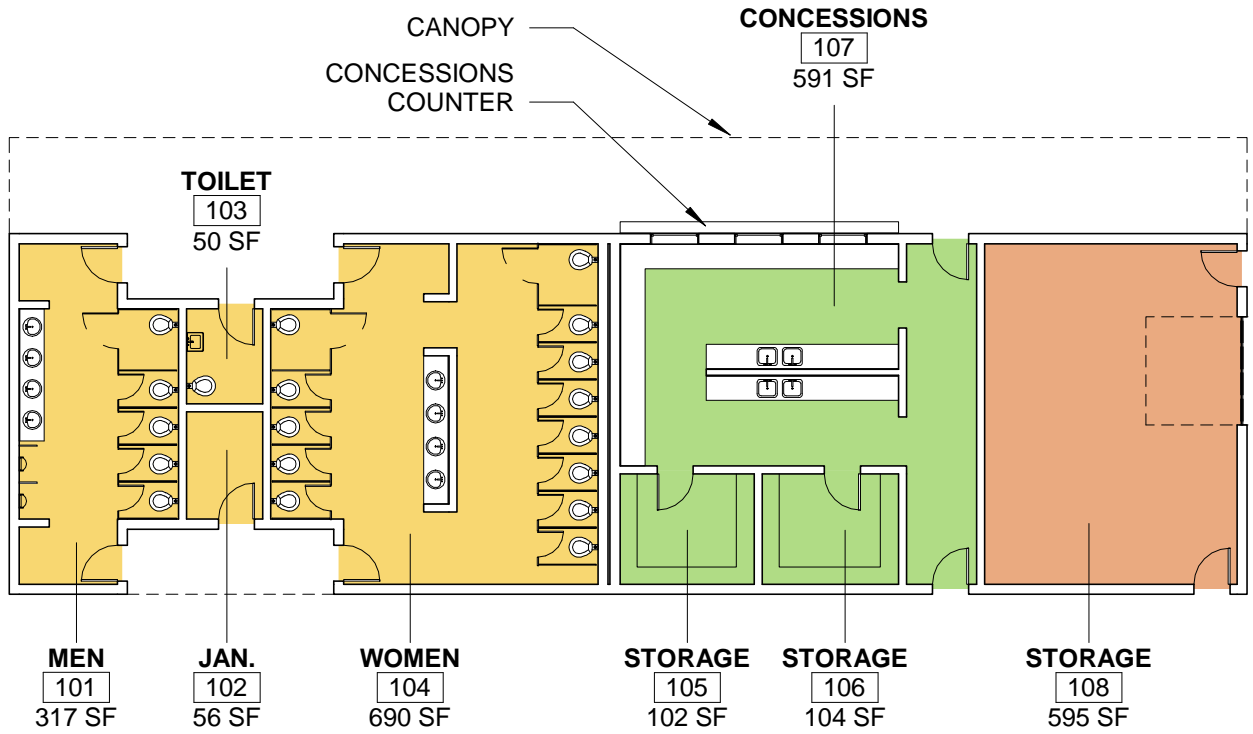

Programming and Improvements – Area D, 2nd Floor

RELATED SCOPES OF WORK

- H-NEW-A-4031
- H-B215-M-4081
- H-B217-M-4082
- H-B212-M-4090
- H-A-A-4021

H-D-A-4027				
Priority		Cost		
		\$\$\$\$		
Coordination by Discipline				
<input checked="" type="checkbox"/>	<input checked="" type="checkbox"/>	<input checked="" type="checkbox"/>	<input checked="" type="checkbox"/>	<input checked="" type="checkbox"/>
A	M	E	P	FP
<input type="checkbox"/>	<input checked="" type="checkbox"/>	<input type="checkbox"/>	<input type="checkbox"/>	<input type="checkbox"/>
S	LS	SC	BE	C

The diagram shows a floor plan with several rooms. Area D is a rectangular room on the right side, highlighted with a red border. To its left is a larger area labeled E. Further left is another area labeled F. Above area D is a vertical strip labeled G. The diagram illustrates the layout of the second floor where the programming improvements are being planned.

EXISTING CONDITIONS

During stakeholder interviews with teachers and staff, it was noted that the existing space surrounding the teacher’s lounge on the second floor is underutilized. This includes the teacher workroom (B215), teacher lounge (B212), OT/PT (B217), and the storage/mechanical space (B216).

With greater efficiencies, there is room for additional program at this location. Some possibilities identified during the stakeholder interviews include:

- a. TV production space.
- b. Dedicated green room space outside of the library.

Depending on the available space created, some items from Work Item H-NEW-A-4031 could also be considered, including:

- c. Computer programming classroom collocated with a math classroom
- d. Robotics collocated with a maker space

RECOMMENDATIONS

With upgrades to the mechanical equipment in B216, the A/E team should identify how the equipment can be more efficiently positioned such that the mechanical space (almost 4600sf) can be reduced to what is necessary to support the equipment. Evacuated space may then be re-programmed for the most appropriate use.

- One study shown on the following diagram shows the OT/PT room located within the evacuated portion of room B216

The teacher workroom and lounge could be more efficiently organized. See plan diagram for one possible solution.

Engage A/E team to further study options and program space available. Coordinate phasing with mechanical unit replacement.

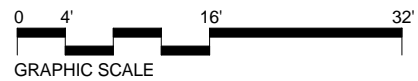
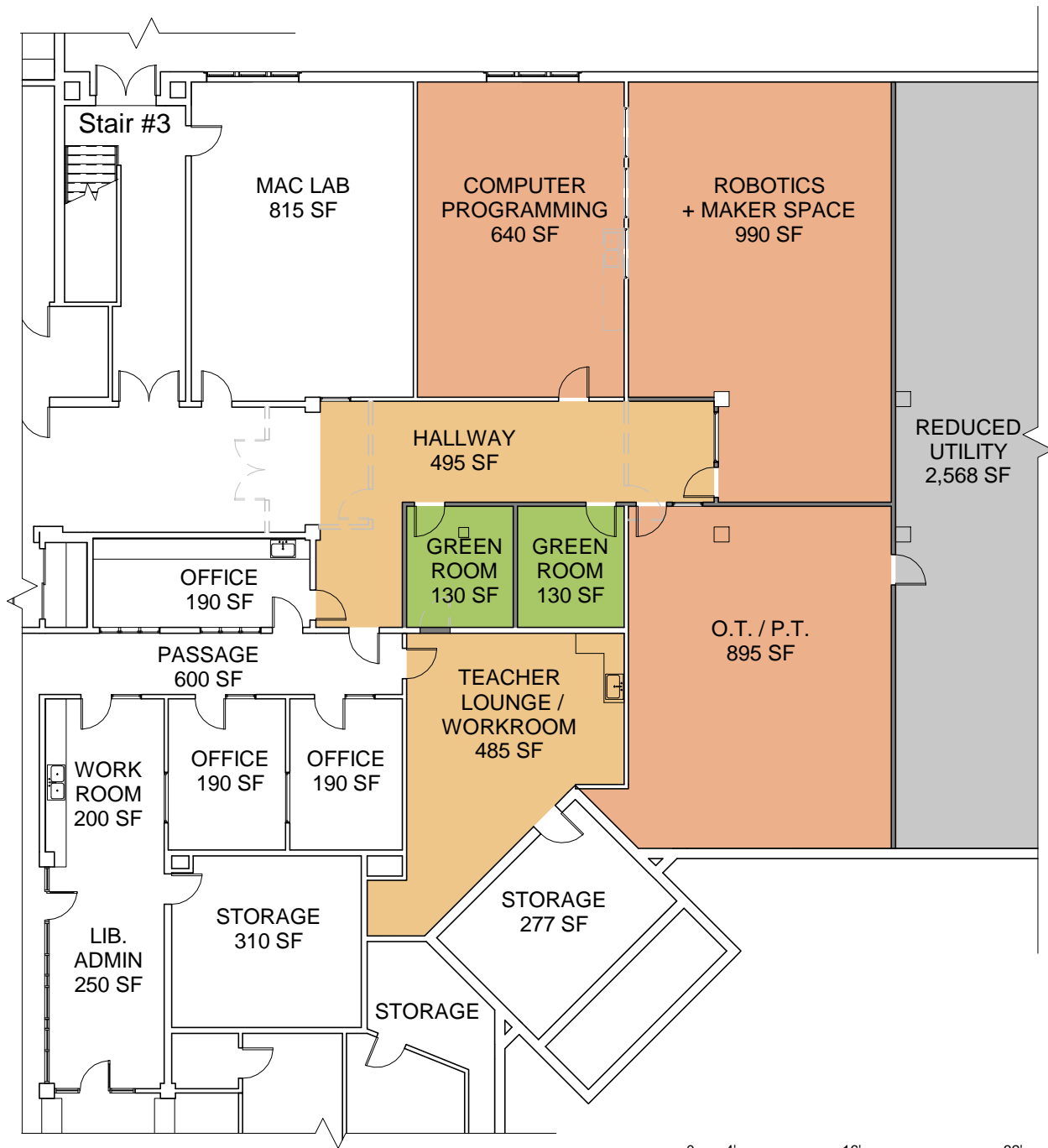

Nurse's Space Improvements

RELATED SCOPES OF WORK

- H-B323-M-4093
- H-B325-P-4110
- H-B322-M-4095

H-D-A-4028				
Priority	Cost			
	\$			
Coordination by Discipline				
<input checked="" type="checkbox"/>	<input checked="" type="checkbox"/>	<input checked="" type="checkbox"/>	<input checked="" type="checkbox"/>	<input type="checkbox"/>
A	M	E	P	FP
<input type="checkbox"/>	<input type="checkbox"/>	<input type="checkbox"/>	<input type="checkbox"/>	<input type="checkbox"/>
S	LS	SC	BE	C

EXISTING CONDITIONS

The nurse's suite is located adjacent to the main office. Its proximity to the main office is a benefit. Interviews with stakeholders suggested the following improvements to the space:

- a. The bathroom contained within the nurse's suite is utilized by students desiring privacy which thereby limits its availability for students visiting the nursing office.
- b. There is insufficient space to treat more than a couple students without concerns of privacy.
- c. The lighting should be on dimming control for people who may be sensitive while they have an injury.
- d. The eye wash station should be relocated to be more accessible.
- e. The medicine cabinet is located on an exterior wall and the temperature swings can be problematic for some medications.
- f. There is no ice machine.

RECOMMENDATIONS

- a. Provide non-gender restrooms throughout the school such that the private restroom located within the nurse's suite is reserved for students visiting the nurse. See Work Item H-ALL-A-4016 for gender neutral restrooms.
- b. Providing additional space to treat additional students in a more private way is likely not possible within the existing space allocated to the nursing suite. If an expansion is pursued as part of another Work Item, the A/E team could evaluate whether the expansion, or the evacuated space, is appropriate for this program.
- c. Install dimming controls. Consider replacement lighting with more color temperature control.
- d. Relocate eye wash.
- e. Relocate medicine cabinet to interior wall.
- f. Install ice machine. Coordinate with eye wash relocation since both involve plumbing work.



Nurses suite waiting area and office visible through door at right.

Theater Improvements

RELATED SCOPES OF WORK

- H-AUD-E-4049
- H-C131-M-4067
- H-D-A-4023

H-AB-A-4029				
Priority		Cost		
		TBD		
Coordination by Discipline				
<input checked="" type="checkbox"/>	<input checked="" type="checkbox"/>	<input checked="" type="checkbox"/>	<input checked="" type="checkbox"/>	<input type="checkbox"/>
A	M	E	P	FP
<input type="checkbox"/>	<input type="checkbox"/>	<input type="checkbox"/>	<input checked="" type="checkbox"/>	<input type="checkbox"/>
S	LS	SC	BE	C

The diagram shows a floor plan with several rooms labeled A, B, C, H, and J. Room B is highlighted with a red rectangle, indicating the location of the theater. Room A is above B, C is to the left, H is to the left of A, and J is below B.

EXISTING CONDITIONS

The existing theater has some improvement needs and some condition issues, including:

- The seating nearly accommodates the entire school plus staff, but not quite.
- The floor slope of the thrust stage makes it difficult to use.
- The stage floor needs to be refinished and the stage curtain replaced with a new fire-treated curtain.
- There are existing roofing leaks as well as water migration through the exterior wall at the back of stage.
- Insufficient changing room space.
- The sink in the back of Room C133 doesn't work.
- Stage lighting is not easily serviceable.

RECOMMENDATIONS

The design team recommends the following improvements:

- Remove thrust stage and replace/reinstall seating that was removed for its installation.
- Refinish or reinstall stage floor and fire-treated curtains
- If general roofing condition is good, then consider Electric Field Vector Mapping (EFVM) to determine leak locations for repair. If roof is generally beyond serviceable life, then re-roof area.
- Investigate sink issues and repair / replace sink.
- Install a winch or hoist to lower and raise stage lighting for adjustments, creating a safer working condition for students and staff.

NEXT LEVEL

- If funds are available, consult a structural engineer about the possibility of creating a fly space over the stage for scenery.

SCOPE OF WORK

- Remove thrust stage and replace/reinstall seating that was removed for its installation.
- Refinish or reinstall stage floor and fire-treated curtains.
- Consult with roofing contractor to determine source of leaks. Consider Electric Field Vector Mapping (EFVM) to determine leak locations for repair. If roof is generally beyond serviceable life, then re-roof area.
- Consult with building envelope specialist to determine water entry issues at exterior wall and advise on options for mitigation and repair as necessary.
- Investigate sink issues and repair / replace sink.
- Install a winch or hoist to lower and raise stage lighting for adjustments, creating a safer working condition for students and staff.
- Refer to sheet H-D-A-4023

Notes on Costing: Given that the scope of this work may vary greatly, please see costing sheet and associated back-up for relevant unit pricing.

Science Rooms Improvements

RELATED SCOPES OF WORK

- H-NEW-A-4031
- H-ALL-P-4102
- H-ALL-P-4099

H-320-A-4030				
Priority		Cost		
		TBD		
Coordination by Discipline				
<input checked="" type="checkbox"/>	<input checked="" type="checkbox"/>	<input checked="" type="checkbox"/>	<input checked="" type="checkbox"/>	<input type="checkbox"/>
A	M	E	P	FP
<input type="checkbox"/>	<input type="checkbox"/>	<input type="checkbox"/>	<input type="checkbox"/>	<input type="checkbox"/>
S	LS	SC	BE	C

EXISTING CONDITIONS

As part of 2004 renovations, most of the science labs were renovated. Room 320 was excluded from this renovation and lags behind the other science rooms. Specifically, shortcomings in Room 320 include:

- The room is too small for the class size. The space is 30' x 30'. Per state standards, to serve a class of 24 students, the space should be 30' x 48'.
- Sinks are too small. Splashing in a science lab could lead to injury.
- Counters are too narrow. Counter width is required for lab experiments.

Generally, all of the science rooms need better heat regulation.

RECOMMENDATIONS

It is the design team's understanding that Room 320 is smaller than the other science rooms because it was subdivided from another one during a prior renovation. While renovations to the counter width and sink type could be pursued, there may be limited payback on these renovations unless the classroom can be made larger again.

If expansion is pursued as part of another Work Item (possibly H-NEW-A-4031), it is conceivable that re-organization could provide an opportunity to right-size this classroom. As part of that work, appropriate counters and sinks should be installed.

Notes on Costing: Given that the scope of this work may vary greatly, please see costing sheet and associated back-up for relevant unit pricing.



Science classroom that is too small for the class size.



Lab sink is too small.

Programming Improvements and Expansion

RELATED SCOPES OF WORK

- H-D-A-4023
- H-D-A-4027
- H-320-A-4030
- H-A123-A-4015

H-NEW-A-4031				
Priority	Cost			
	TBD			
Coordination by Discipline				
<input checked="" type="checkbox"/>	<input checked="" type="checkbox"/>	<input checked="" type="checkbox"/>	<input checked="" type="checkbox"/>	<input checked="" type="checkbox"/>
A	M	E	P	FP
<input checked="" type="checkbox"/>	<input checked="" type="checkbox"/>	<input checked="" type="checkbox"/>	<input checked="" type="checkbox"/>	<input checked="" type="checkbox"/>
S	LS	SC	BE	C

EXISTING CONDITIONS

In the stakeholder interviews with teachers and administration, some consistent themes were identified:

- a. Experiential learning (maker space, hub space, robotics, etc.) has become increasingly prominent as part of high school education. Space for these programs in the existing school building footprint is limited. As such, the spaces assigned are often less than ideal. Also, the spaces assigned typically dislocate or partially reprogram space previously used for another use resulting in a domino effect.
- b. The expansion of experiential learning, among other uses, has resulted in a real shortage of multi-purpose, flexible meeting rooms that can accommodate a range of sizes and privacy. For example, the current robotics room B306 occupies a former lecture space with raked seating. The space is not ideal for robotics and took one of the few dedicated speaking / assembly spaces in the school.
- c. The library represents one large gathering space (with tables and shelving moved out of the way) that remains. As such, it is used every year for AP testing, which means it's not available for use as a library during 3 weeks of the school year.
- d. There is a need for dedicated computer programming and math classrooms.

RECOMMENDATIONS

Explore an addition to the high school, to include the following program items:

- New multi-purpose classroom / testing center for 45-50 students
- Hub space (2 offices, work space, presentation space for 20-40 people)
- Flexible meeting rooms, multiple sizes
- Computer programming classroom collocated with a math classroom
- Robotics collocated with a maker space

SCOPE OF WORK

Engage an A/E firm to explore where an addition would best be sited (second floor addition over gymnasium, expansion of the lower level, etc.), to program the addition, and to develop schematic design options for pricing by a third-party cost estimator.

If funding for the expansion is approved, then the design team would complete the design development, construction, and bid documents for a contractor to bid and execute the work.

Notes on Costing: Given that the scope of this work may vary greatly, please see costing sheet and associated back-up for relevant unit pricing.

General Flooring Repair and Upgrades

RELATED SCOPES OF WORK
H-ALL-A-4009

H-ALL-A-4032	
Priority	Cost
	\$\$\$\$
Coordination by Discipline	
<input checked="" type="checkbox"/>	<input type="checkbox"/> <input type="checkbox"/> <input type="checkbox"/> <input type="checkbox"/>
A	M E P FP
<input type="checkbox"/>	<input type="checkbox"/> <input type="checkbox"/> <input type="checkbox"/> <input type="checkbox"/>
S	LS SC BE C

EXISTING CONDITIONS

- a. Existing VCT tile has high annual maintenance cost. Cleaning process takes significant manpower and time. Entire sections of the building are unusable for the duration of maintenance.
Note: VCT tile in some locations may still contain asbestos. Hazmat testing remediation is not included in costing.
- b. Square Ceramic Tile (Small Format) – Existing tile is in fair condition in most locations. It is extremely durable, although does not convey an updated appearance.
- c. Quarry Tile – Existing tile is in good condition and is extremely durable, although does not convey an updated appearance and has been reported to be a maintenance issue.
- d. Broadloom Carpeting – Carpeting is in serviceable condition.



Cape Elizabeth Schools Needs Assessment



RECOMMENDATIONS

- a. Design team recommends abating or encapsulating any remaining existing VCT containing asbestos.
- b. Square Ceramic Tile (Small Format) – Replace tiles where missing or loose.
- c. Quarry Tile – Consider covering existing tile with slip resistant epoxy coating.
- d. Broadloom Carpeting – Consider replacing carpeting with cushioned carpet tile. This could be done one wing or level at a time. This would allow damaged tiles to be replaced as needed. In addition to aesthetic update, comfort would be improved in these rooms.

NEXT LEVEL

- a. Replace vinyl flooring throughout school. This could be done one wing at a time.
d. If carpeting is replaced, the design team recommends disposing of existing carpeting through recycling program and diverting it from the landfill.

SCOPE OF WORK

- a. Remove and replace vinyl flooring in entirety of wing. Recycle existing materials removed from space where possible. Prep sub-floor to receive new finished flooring.

Compromised Wall Assembly

H-ALL-BE-4033				
Priority	Cost			
	\$			
Coordination by Discipline				
<input checked="" type="checkbox"/>	<input type="checkbox"/>	<input type="checkbox"/>	<input type="checkbox"/>	<input type="checkbox"/>
A	M	E	P	FP
<input checked="" type="checkbox"/>	<input type="checkbox"/>	<input type="checkbox"/>	<input checked="" type="checkbox"/>	<input type="checkbox"/>
S	LS	SC	BE	C

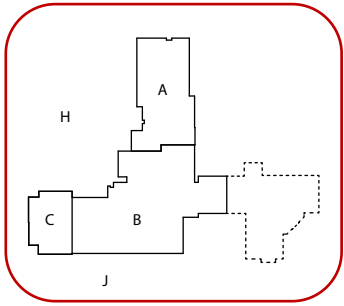

RELATED SCOPES OF WORK

Not Applicable

EXISTING CONDITIONS

There are numerous locations of deterioration at the interior finishes around windows and the precast panel system they are set in. This condition was noted in the 2012 Harriman report, *Town of Cape Elizabeth Seven Building Facility Study*. As noted in the Harriman report, it appears that water penetration and condensation are the primary drivers of the problem.

While the Facilities Department has an ongoing maintenance project of replacing failing windows as budget permits, there are larger issues that replacing individual windows will not solve. If only glazing is replaced, the existing aluminum frame is not thermally-broken resulting in condensation on interior surfaces. Replacing the entire window is difficult, however, because the jambs are mechanically attached to a precast anchor.

The precast panel is anchored to the structure through a series of connection angles and weld plates, some of which appear to be rusting and staining the surface on the exterior. Per the original drawings, the interior finishes are insulation and drywall without a vapor barrier. The thermal mass of the concrete panel, combined with the absence of a vapor barrier, suggests that the dew point is somewhere near the drywall. Further forensic analysis and dew point analysis could confirm this supposition.

The design team did not observe every condition of this assembly, but many rooms viewed show signs of drywall cracking, peeling paint, and in some cases CMU cracking. Where water penetration and/or condensation is a frequent problem, there is a high potential for mold buildup and the associated health risks that can follow. A list of some specific issues follows, but it is not a comprehensive list:

- a. Cracking at intersection of window to adjacent finish.
- b. Cracking at intersection of finishes (drywall to CMU).
- c. Water damage at head and/or sill.
- d. Sever moisture infiltration.
- e. Parging shows signs of water infiltration.
- f. Cracking at CMU.
- g. Peeling paint, indicative of moisture infiltration.

Room	Condition Key	Room	Condition Key	Room	Condition Key
A106	e	213	c	B305	c
C100	f	214	c	314	a
104	b, c	215	c	316	a
C111	c, see note 1.	216	c, f	317A	d
C134	g	217	c	319	a
211	b, c	B302	a	320	a
212	c				

Note 1. Window components mis-aligned in opening, wall cavity visible, moisture damage visible.

RECOMMENDATIONS

The design team recommends a forensic analysis by a building envelope specialist to verify and confirm our suspicions, and to develop an appropriate plan of action to repair this condition throughout the school.

Notes on Costing: Cost included here indicates allowance for forensic investigation only.

Cape Elizabeth Schools Needs Assessment



Drywall peeling from moisture infiltration / condensation and CMU cracking.



Non-thermally broken aluminum frames set into precast concrete panel are a vessel for condensation to form on the interior surfaces.

Roof Compliance Issues

RELATED SCOPES OF WORK H-A-S-4114

H-ALL-BE-4034				
Priority		Cost		
		TBD		
Coordination by Discipline				
<input checked="" type="checkbox"/>	<input checked="" type="checkbox"/>	<input checked="" type="checkbox"/>	<input checked="" type="checkbox"/>	<input type="checkbox"/>
A	M	E	P	FP
<input checked="" type="checkbox"/>	<input type="checkbox"/>	<input type="checkbox"/>	<input type="checkbox"/>	<input type="checkbox"/>
S	LS	SC	BE	C

EXISTING CONDITIONS

- Overall Roof Membrane Condition: Areas replaced in 2004 are approaching their end of life. Original flashing may remain in some locations. Significant patching and evidence of ponding exists throughout. Leaks have been reported on interior, but it is undetermined if related to roof membrane failure.
- Roof Hatches: These appear to be un-insulated and contribute to thermal bridging. Roof hatches are not currently OSHA compliant for fall protection.
- Access Ladders: Access ladders are not currently OSHA compliant for fall protection.
- Penetrations and Drains: See Plumbing items
- Insulation: Harriman report of 2012 indicates several areas are covered with 5" of insulation, bolted thru insulation and deck. If tapered rigid XPS, non-continuous R-25 assembly value is assumed.
- See Harriman report of 2012 for detailed discussion of roof items. Conditions outlined appear to be largely unchanged.



RECOMMENDATIONS

- The design team recommends that guard rails and stairs are provided to conform with OSHA requirements. Also see related mechanical items referenced above.
- Make improvements noted in Harriman report of 2012
- Install insulated roof hatch assemblies w/ appropriate fall protection
- Replace roof in areas where structural upgrades are required, see Structural items referenced above.
- Consider replacement in areas where roof is at the end of life, particularly in places where large mechanical units are being replaced, removed or relocated, or where roofing membrane was installed incorrectly.

NEXT LEVEL

- Where possible, installation of additional insulation is recommended to improve building performance and reduce the heating and cooling load. Good practice would be to bring roof insulation into minimum compliance with pending adoption of IECC 2015: R-30ci above deck OR R-19 above deck with R-11LS below deck. This would need to be reviewed by an engineering team to review the impact of additional load capacity on existing structure due to increased snow load and would require coordination with mechanical systems to ensure their performance is accounting for the change in heat/cooling load.

Cape Elizabeth Schools Needs Assessment

- Reinforce roof surface as required for installation of Solar Panels. Hire a structural engineer to analyze and design roof as needed for solar panel selection and installation.

SCOPE OF WORK

- Install galvanized guard rails and stairs in conformance with OSHA requirements.
- Replace non-conforming existing access ladders.
- Replace roof assembly in its entirety in areas where structural upgrades are required.
- Install insulated roof hatch, min. size required by AHJ. Provide fall protection meeting OSHA requirements.
- Replace EPDM roof surface in areas where membrane is at the end of life, particularly in places where large mechanical units are being replaced, removed or relocated, or where roofing membrane was installed incorrectly. Assess condition of assembly below and either re-surface or replace entire assembly as needed.
- Where replacement of entire roof assembly is being considered, provide insulation in compliance with current IECC code requirements at time of replacement. Architect to provide recommendation for replacement assemblies.

Notes on Costing: Given that the scope of this work may vary greatly, please see costing sheet and associated back-up for relevant unit pricing and allowances.

High School Roof Diagrams



ROOF #	ROOF DESCRIPTION	REPLACED
1	EPDM	UNKNOWN
2	EPDM	UNKNOWN
3	EPDM	UNKNOWN
4	EPDM	UNKNOWN
5	EPDM	2004
6	EPDM	UNKNOWN
7	EPDM	UNKNOWN
8	EPDM	UNKNOWN
9	EPDM	2004
10	EPDM (SLOPED)	UNKNOWN
11	EPDM	2004
12	EPDM	UNKNOWN
13	NOT INCLUDED (POOL)	

ROOF HATCH KEY

- ROOF REPLACED IN 2004
- ROOF CONDITION IS UNCERTAIN
- INDICATES ROOF NOT INCLUDED

GENERAL NOTES:

- Lack of pitch reduces typ. 20-25 year lifespan.
- Seam re-flashing as part of regular maintenance.
- Ponding deteriorates lap seams early.
- Air spaces between membrane and insulation make epdm more susceptible to puncturing.
- Mech. fastened through roof planks. Thermal bridging and dimpling could contribute to leakage.
- May not meet current requirements for wind uplift and drainage slope.
- Some areas installed with UV coating side down, may have premature failure.

Cape Elizabeth Schools Needs Assessment

Bus Driveway

Construct segregated bus driveway to Ocean House Road for exiting bus traffic only

RELATED SCOPES OF WORK

Not Applicable

H-EXT-C-4037	
Priority	Cost
	\$\$
Coordination by Discipline	
<input type="checkbox"/>	<input type="checkbox"/>
<input type="checkbox"/>	<input type="checkbox"/>
<input type="checkbox"/>	<input type="checkbox"/>
<input type="checkbox"/>	<input type="checkbox"/>
<input type="checkbox"/>	<input checked="" type="checkbox"/>
ST	LS
SC	BE
C	

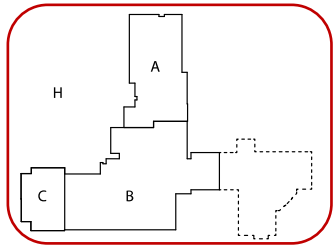

EXISTING CONDITIONS

Currently the bus queues at the High School block students exiting to cars in the parking area. During dismissal there is conflict between students crossing in front of and behind the queued busses. Since there is only one entrance/exit road for the High School there is conflict between the buses and student operated cars. This is a safety concern as many students try to “make a run for it” as buses depart the school to beat the buses out of the driveway so they don’t have to wait at the intersection with the High School and Ocean House Road.

RECOMMENDATIONS

This existing conflict could be eliminated with a separate bus exit onto Ocean House Road. The High School Property is shaped in such a manner that a 20-foot strip of land exists between Tax Maps U21-17 and U21-16 &16A. This strip is contiguous with the High School property and would allow room to construct a 12-foot-wide exit lane for buses only. Additionally, a timed signal could be added at the intersection of this Bus Exit Lane and Ocean House Road such that it only operates when school is in session and only during the 10-minute window when buses are exiting the high school. At all other times this access would be gated and locked.

NEXT LEVEL

Since the access would be gated, local first responders could be provided with a Knox Box Key so that the access could be utilized in emergency situations. It is the opinion of the designers that based on the width of the property, this access could never be more than a bus exit lane without obtaining property from the abutting landowners.

SCOPE OF WORK

Re-orient the parking and bus circulation lane around the high school. The bus exit lane is 620 lf long and will require construction of a retaining wall to ensure that the driveway maintains maximum distance from the edge of the track and associated athletic field. In addition, it would be necessary to negotiate an easement or “in fee” purchase of a portion of adjacent land to ensure that the adequate horizontal curve is designed in the driveway.



Provide additional camera coverage and exterior lighting.

RELATED SCOPES OF WORK

Not Applicable

H-EXT-E-4038				
Priority	Cost			
	\$			
Coordination by Discipline				
<input type="checkbox"/>	<input type="checkbox"/>	<input checked="" type="checkbox"/>	<input type="checkbox"/>	<input type="checkbox"/>
A	M	E	P	FP
<input type="checkbox"/>	<input type="checkbox"/>	<input type="checkbox"/>	<input type="checkbox"/>	<input checked="" type="checkbox"/>
S	LS	SC	BE	C

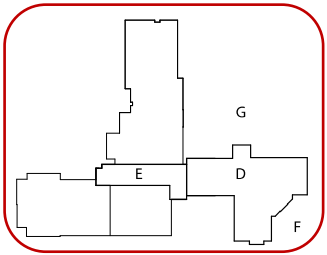

EXISTING CONDITIONS

The site lighting consists of pole mounted light fixtures in the parking and roadway areas.

RECOMMENDATIONS

Provide additional pole mounted light fixtures and cameras to provide adequate lighting and monitoring coverage.

SCOPE OF WORK

Provide additional pole mounted light fixtures and cameras to provide adequate coverage in parking areas. Light fixtures shall be LED type that are dark sky compliant, and aesthetically match existing fixtures. Connect to existing exterior lighting controls. Provide cameras to match existing exterior cameras and connect to centralized security monitoring.

Upgrade public address phone system to VOIP with paging

RELATED SCOPES OF WORK
Not Applicable

H-ALL-E-4039				
Priority	Cost			
	\$\$			
Coordination by Discipline				
<input checked="" type="checkbox"/>	<input type="checkbox"/>	<input checked="" type="checkbox"/>	<input type="checkbox"/>	<input type="checkbox"/>
A	M	E	P	FP
<input type="checkbox"/>	<input type="checkbox"/>	<input type="checkbox"/>	<input type="checkbox"/>	<input type="checkbox"/>
S	LS	SC	BE	C

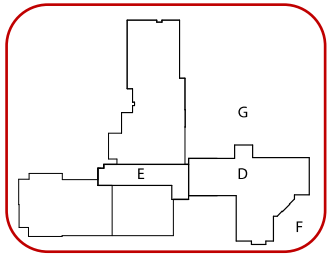

EXISTING CONDITIONS

The existing phone system is outdated, and not all locations have handsets. The intelligibility of the paging system is low, and the system is aging.

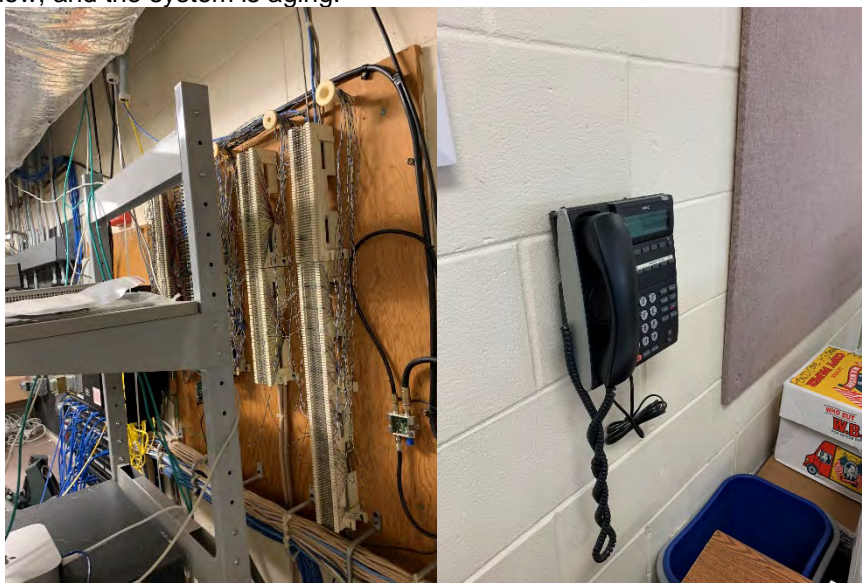

RECOMMENDATIONS

It is recommended that the existing phone system and paging be removed, and replaced with a Voice of IP phone system that includes paging, and intercom. The existing system uses older technology. With an upgraded system, multiple systems can be combined into one system. The paging, the phone, and the intercom can use one system to perform multiple functions. In addition the new technology has better intelligibility, and features not available with the traditional analog phone system.

SCOPE OF WORK

Removal of telephone wiring to phone handsets throughout the facility. Removal of intercom/paging speakers and wiring. Installation of new CAT6 wiring, headsets, and master consoles in office.

Replace NM wiring above ceilings

RELATED SCOPES OF WORK

Not Applicable

H-ALL-E-4040	
Priority	Cost
	\$
Coordination by Discipline	
<input type="checkbox"/>	<input type="checkbox"/>
<input type="checkbox"/>	<input checked="" type="checkbox"/>
<input type="checkbox"/>	<input type="checkbox"/>
<input type="checkbox"/>	<input type="checkbox"/>
<input type="checkbox"/>	<input type="checkbox"/>
<input type="checkbox"/>	<input type="checkbox"/>
S	C

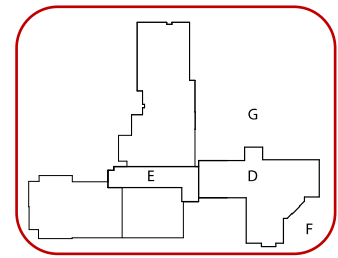

EXISTING CONDITIONS

The wiring in the building is a combination of non-metallic (Romex) cabling, MC-cable (metal clad) and wiring in conduit. The current code does not allow NM wiring above SAT ceilings.



RECOMMENDATIONS

The extent of the cabling should be evaluated, and replaced. This can be done at the time of upgrades to lighting, or replacement of the equipment the wiring serves, if those upgrades are performed, but needs to be considered when upgrades are performed, as the existing wiring cannot be re-used. If existing equipment is not replaced, the wiring should be replaced.

SCOPE OF WORK

Determine the extent of the non-metallic Remove existing non-metallic wiring above ceiling, and replace with MC-cable.

Upgrade emergency lighting

RELATED SCOPES OF WORK

Not Applicable

H-ALL-E-4041	
Priority	Cost
	\$
Coordination by Discipline	
<input type="checkbox"/>	<input type="checkbox"/>
<input type="checkbox"/>	<input checked="" type="checkbox"/>
<input type="checkbox"/>	<input type="checkbox"/>
A	M E P FP
<input type="checkbox"/>	<input type="checkbox"/>
<input type="checkbox"/>	<input type="checkbox"/>
S	LS SC BE C

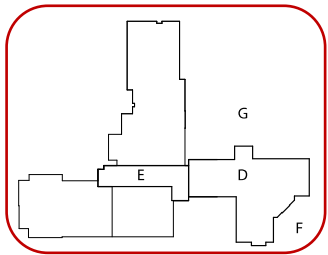

EXISTING CONDITIONS

The existing emergency lighting are older style, and consist of a combination of self-contained battery units, remote dual and single heads. The single heads do not meet current code for egress lighting. It does not appear that there is adequate coverage, to meet the 1 fc requirement from NFPA 101, and not all exit doors have an egress emergency light. A number of instances, the fixtures appear to be damaged.



RECOMMENDATIONS

It is recommended that the emergency egress lighting be replaced.

SCOPE OF WORK

Remove existing emergency lighting, provide emergency egress lighting to meet NFPA requirements. Provide LED, dual head fixtures with battery backup in corridors and along egress paths, and exterior emergency LED fixtures at egress doors.

Provide metering for building

RELATED SCOPES OF WORK

Not Applicable

H-ALL-E-4042	
Priority	Cost
	\$
Coordination by Discipline	
<input type="checkbox"/>	<input type="checkbox"/>
<input checked="" type="checkbox"/>	<input type="checkbox"/>
<input type="checkbox"/>	<input type="checkbox"/>
A	M
E	P
FP	
<input type="checkbox"/>	<input type="checkbox"/>
<input type="checkbox"/>	<input type="checkbox"/>
S	LS
SC	BE
C	

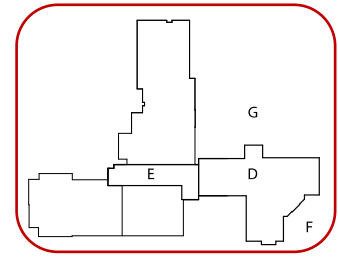

EXISTING CONDITIONS

The existing electrical demand on the buildings is unknown.

RECOMMENDATIONS

In order to determine the electrical usage of the buildings, and demand on the equipment, it is recommended an electrical meter be placed on the service entrance to determine the usage. This information can be used to accurately size replacement equipment for the facility.

SCOPE OF WORK

Place a smart meter on the service entrance that measures electrical usage, including peak demand for a 30-day period. The meter is to be used for evaluation of usage, but will remain for future use to have the ability to monitor electrical usage.

Replace T12 fluorescent fixtures with LED

RELATED SCOPES OF WORK
Not Applicable

H-B211-E-4043				
Priority	Cost			
	\$			
Coordination by Discipline				
<input type="checkbox"/>	<input type="checkbox"/>	<input checked="" type="checkbox"/>	<input type="checkbox"/>	<input type="checkbox"/>
A	M	E	P	FP
<input type="checkbox"/>	<input type="checkbox"/>	<input type="checkbox"/>	<input type="checkbox"/>	<input type="checkbox"/>
S	LS	SC	BE	C

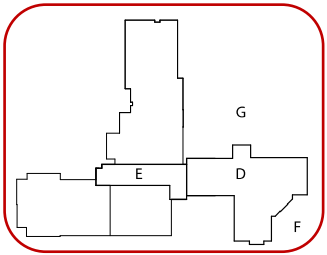

EXISTING CONDITIONS

Room B211 has Older style fluorescent fixtures with T12 lamps. These fixtures are outdated and not energy efficient.

RECOMMENDATIONS

Replace fixtures with newer style LED fixture.

SCOPE OF WORK

Remove and replace T12 fixtures with surface mount, LED strip fixtures.

Provide additional circuits to classrooms

RELATED SCOPES OF WORK

Not Applicable

EM-ALL-E-4044				
Priority	Cost			
	\$\$			
Coordination by Discipline				
<input type="checkbox"/>	<input type="checkbox"/>	<input checked="" type="checkbox"/>	<input type="checkbox"/>	<input type="checkbox"/>
A	M	E	P	FP
<input type="checkbox"/>	<input type="checkbox"/>	<input type="checkbox"/>	<input type="checkbox"/>	<input type="checkbox"/>
S	LS	SC	BE	C

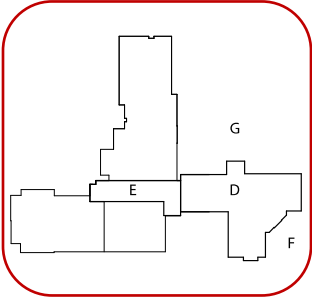

EXISTING CONDITIONS

The existing classrooms have limited receptacles and limited circuits for each classroom.

RECOMMENDATIONS

It is recommended with the addition of technology in the classrooms, that each classroom be provided with additional dedicated quad receptacles. It is recommended that each classroom have a minimum of two circuits for convenience receptacles

SCOPE OF WORK

Provide additional receptacles in each classroom, with a minimum of two circuits per room.

Provide additional 120/208 volt panels for spare capacity.

RELATED SCOPES OF WORK
Not Applicable

H-ALL-E-4045				
Priority	Cost			
	\$\$			
Coordination by Discipline				
<input checked="" type="checkbox"/>	<input type="checkbox"/>	<input checked="" type="checkbox"/>	<input type="checkbox"/>	<input type="checkbox"/>
A	M	E	P	FP
<input type="checkbox"/>	<input type="checkbox"/>	<input type="checkbox"/>	<input type="checkbox"/>	<input type="checkbox"/>
S	LS	SC	BE	C

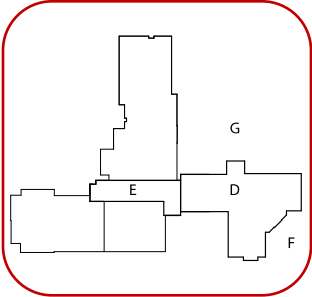

EXISTING CONDITIONS

The existing panels located throughout the facility have limited to no spare capacity.

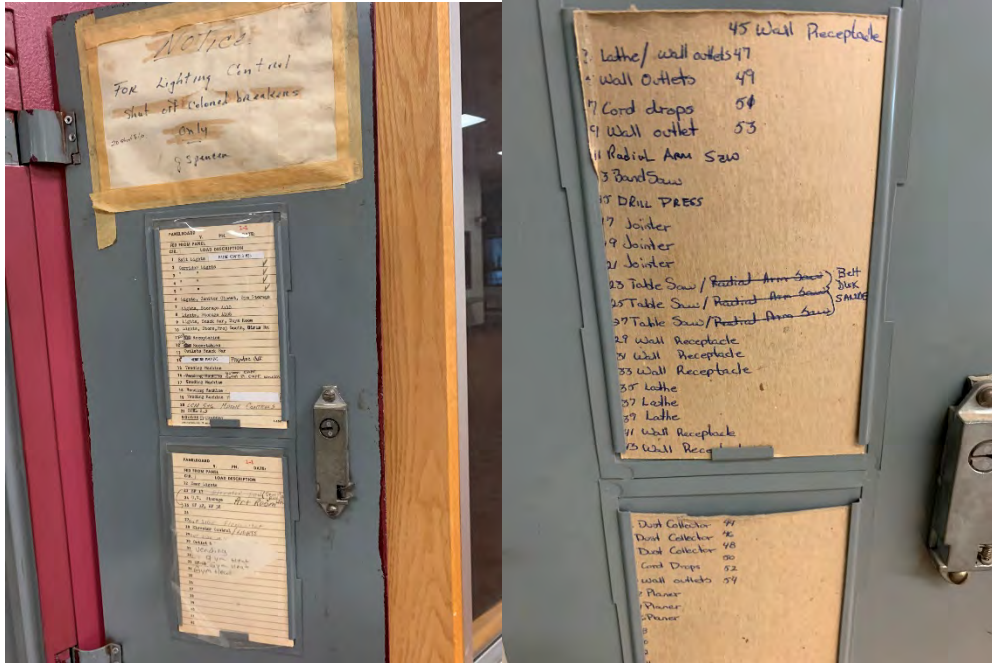

RECOMMENDATIONS

It is recommended that additional panels be provided throughout the facility to allow for addition of additional circuits.

SCOPE OF WORK

Provide additional 120/208volt three phase panels on each floor and classroom wing, with feeders to main electrical room. The building metering will need to be performed prior to addition of panels to determine the capacity of the main electrical service.

Provide time clocks in corridors

RELATED SCOPES OF WORK

H-A-A-4021

EM-ALL-E-4046					
Priority	Cost				
	\$				
Coordination by Discipline					
<input checked="" type="checkbox"/>	<input type="checkbox"/>		<input checked="" type="checkbox"/>	<input type="checkbox"/>	<input type="checkbox"/>
A	M		E	P	FP
<input type="checkbox"/>	<input type="checkbox"/>	<input type="checkbox"/>	<input type="checkbox"/>	<input type="checkbox"/>	
S	LS	SC	BE	C	

EXISTING CONDITIONS

The existing are older style, and consists of a combination of 2x2 and 2x4' recessed fluorescent T8 fixtures. Controls consist of a combination of local keyed switches. Lighting levels appear to be adequate. Occupancy sensors were not present, and no form of automatic off for corridor lighting was noted.

RECOMMENDATIONS

It is recommended that switching be replaced with programmable time clock to provide for automatic off.

SCOPE OF WORK

Provide programmable time clock and connection to corridor lighting. Provide programming and training for owner on operation.

Upgrade Fluorescent lighting

RELATED SCOPES OF WORK

H-202-A-4014
H-A313-P-4101

H-ALL-E-4048	
Priority	Cost
	\$
Coordination by Discipline	
<input checked="" type="checkbox"/>	<input type="checkbox"/>
<input checked="" type="checkbox"/>	<input checked="" type="checkbox"/>
<input type="checkbox"/>	<input type="checkbox"/>
A	M
E	P
FP	
<input type="checkbox"/>	<input type="checkbox"/>
<input type="checkbox"/>	<input type="checkbox"/>
S	LS
SC	BE
C	

EXISTING CONDITIONS

The common spaces typically have 2x4 recessed fluorescent fixtures with three or four lamps with local switches. Lighting levels appear to be adequate. Occupancy sensors were not present, and no form of automatic off for lighting is present.

RECOMMENDATIONS

It is recommended that existing fluorescent fixtures be replaced with higher efficient LED fixtures with automatic off lighting controls with dimming. LED fixtures can provide the same amount of light, with lower power consumption. In addition, fixtures with automatic controls and dimming capability with provide further energy savings. Lighting load account for a large portion of the energy usage in most facilities, and can reduce operating costs. In addition, LED fixtures do not require the replacement of lamps that the fluorescent fixtures require, providing further savings in maintenance.

SCOPE OF WORK

Remove existing lighting in common spaces. Provide LED direct/indirect fixtures with manual on/automatic off occupancy sensors, and dimming controls.

Replace intercom system

RELATED SCOPES OF WORK

H-ALL-E-4039

H-ALL-E-4050				
Priority	Cost			
	\$			
Coordination by Discipline				
<input type="checkbox"/>	<input type="checkbox"/>	<input checked="" type="checkbox"/>	<input type="checkbox"/>	<input type="checkbox"/>
A	M	E	P	FP
<input type="checkbox"/>	<input type="checkbox"/>	<input type="checkbox"/>	<input type="checkbox"/>	<input type="checkbox"/>
S	LS	SC	BE	C

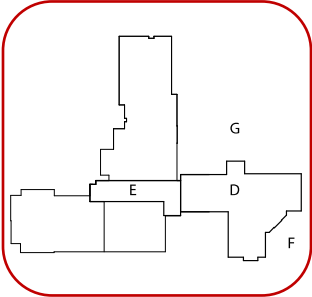

EXISTING CONDITIONS

The existing intercom system intelligibility is poor.

RECOMMENDATIONS

It is recommended a new system to be provided integrated with the VOIP phone upgrade.

SCOPE OF WORK

Provide speakers in common spaces that do not have a VOIP telephone connected to the VOIP system.

Combine Fire Alarm Occupant Notification Systems

Multiple occupant notification systems currently serve the school and are recommended to be combined to a single system

RELATED SCOPES OF WORK

Not Applicable

H-ALL-FP-4051					
Priority	Cost				
	\$\$\$\$				
Coordination by Discipline					
<input checked="" type="checkbox"/>	<input type="checkbox"/>		<input checked="" type="checkbox"/>	<input type="checkbox"/>	<input checked="" type="checkbox"/>
A	M		E	P	FP
<input type="checkbox"/>	<input checked="" type="checkbox"/>	<input type="checkbox"/>	<input type="checkbox"/>	<input type="checkbox"/>	
S	LS	SC	BE	C	

EXISTING CONDITIONS

Parts of the building are served by two separate occupant notification systems. The first is a voice notification system using speakers, the second using horns to provide a tone-based notification signal.

The two voice notification systems additionally appear to be two separate systems, one Notifier and the other Wheelock, serving different areas of the building.



of

RECOMMENDATIONS

Combine fire alarm occupant audible notification to be a single voice evacuation system throughout all areas of the building. Replace horns and horn-strobe notification appliances, non-voice, with speaker and speaker-strobe voice notification appliances.

NEXT LEVEL

Consider specification of intelligibility levels throughout normally occupied areas of the building when designing new voice notification system. NFPA 72 requires audibility (can the message be heard), but provides no specified level of intelligibility (can the message be understood). This will require additional quantities of audible notification appliances at a lower volume distributed throughout these Acoustically Distinguishable Spaces (ADS) designated for intelligibility.

SCOPE OF WORK

Provide new amplifiers, cabling of new audio circuits, and replacement of existing notification appliances with speakers and speaker-strobes in areas of the building currently served by horns. Combine voice evacuation interface head end equipment to provide a single integrated system throughout all areas.

Replacement of existing occupant notification will require additional notification appliance locations for compliance with current code requirements for audible and visual coverage requirements.

Designation of Acoustically Distinguishable Spaces (ADS) for intelligibility will require additional quantities of occupant notification speakers.

Life Safety: Room Signage

RELATED SCOPES OF WORK
H-ALL-A-4017

H-ALL-LS-4052	
Priority	Cost
	\$\$
Coordination by Discipline	
<input checked="" type="checkbox"/>	<input type="checkbox"/>
<input type="checkbox"/>	<input type="checkbox"/>
<input type="checkbox"/>	<input type="checkbox"/>
<input type="checkbox"/>	<input type="checkbox"/>
A	M E P FP
<input type="checkbox"/>	<input checked="" type="checkbox"/>
<input type="checkbox"/>	<input type="checkbox"/>
<input type="checkbox"/>	<input type="checkbox"/>
S	LS SC BE C

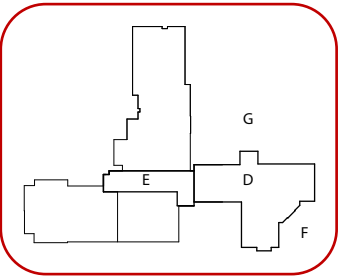

EXISTING CONDITIONS

- Room signage is non-standardized throughout the facility: Some rooms have signage; some rooms are unidentified or have temporary alterations to existing signage; there are different types of signage. Classrooms do not have consistent signage at exterior windows, temporary or otherwise.
- Elevator Lobbies lack compliant life safety and ANSI compliant signage.
- Exterior doors do not have consistent ANSI compliant identifying signage on both the interior and exterior.

RECOMMENDATIONS

- Interior Signage: the design team recommends installing unified, permanent, ANSI compliant identifying signage on all doors facing the corridor, and primary entry doors along egress paths of travel. Rooms should be identified by name and number. See item H-ALL-A-4017 for additional notes on doors.
- Exterior Signage: doors should be updated to have consistent ANSI compliant identifying signage on both the exterior and interior of the door. See item H-ALL-LS-4052.
- Exterior Signage at windows should be consistent for all spaces.
- All doors and exterior windows: Signage should correspond to registered Life Safety documents on file with AHJ. The design team recommends these documents be updated if necessary. See updated plans with including room numbers in appendix F.
- Unisex restroom signage throughout should be updated to comply with requirements for gender neutral signage.

Notes on Costing: An allowance has been provided for this item. Given that the scope of this work may vary, the exact cost provided in the back-up may change depending on verified field conditions.



Cape Elizabeth Schools Needs Assessment

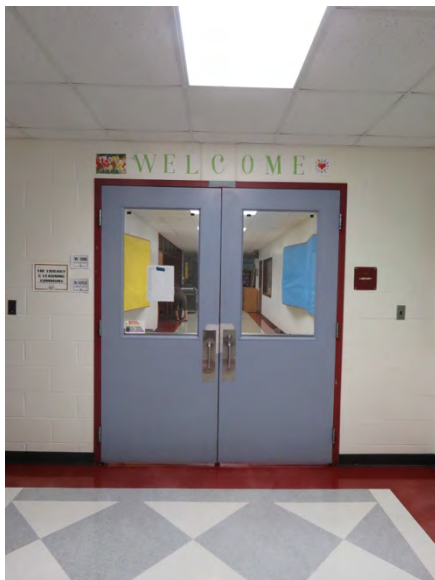
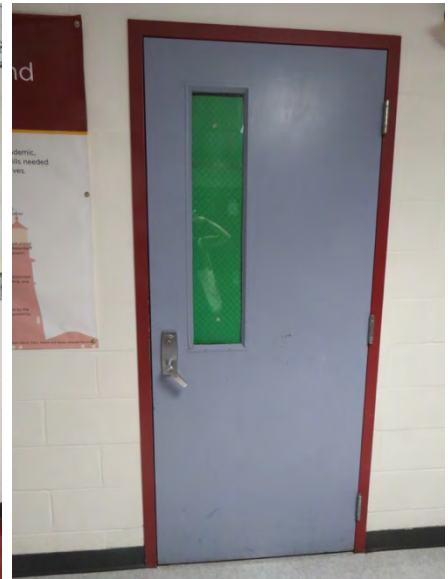

Wall Extension: Life Safety

RELATED SCOPES OF WORK

H-ALL-FP-4119

H-ALL-LS-4053				
Priority		Cost		
		\$\$		
Coordination by Discipline				
<input checked="" type="checkbox"/>	<input checked="" type="checkbox"/>	<input checked="" type="checkbox"/>	<input type="checkbox"/>	<input checked="" type="checkbox"/>
A	M	E	P	FP
<input type="checkbox"/>	<input checked="" type="checkbox"/>	<input type="checkbox"/>	<input type="checkbox"/>	<input type="checkbox"/>
S	LS	SC	BE	C

EXISTING CONDITIONS

Several walls do not extend to deck between classroom and storage areas and effectively have no rated separation between them. The following rooms were observed to have a continuous plenum space:

- a. B305, 315, storage (note: wall appears to go to deck at robotics lab side, consistent with addition extent)
- b. 315, Storage, 301, 302, 317
- c. 317A, 318, JC, ER, Prep/Storage, 319, 320, 321
- d. 211, JC, Student Workroom
- e. Wall did not extend to ceiling in A106 Storage, however gyp. ceiling was provided in A135 Kiln Room

Please note that locations were spot checked within each building wing. This list may not be an exhaustive list of all locations.

RECOMMENDATIONS

- Contractor to review locations where separations are required and verify wall conditions in those locations. See plan diagrams.
- Wall to be extended to deck in locations where separation is required but not currently provided.
- Where walls are to be continued to deck, coordinate all work with mechanical systems to ensure air supply and ventilation requirements are met. Also coordinate penetrations required for any electrical, plumbing and sprinkler piping penetrations. See work items noted above.

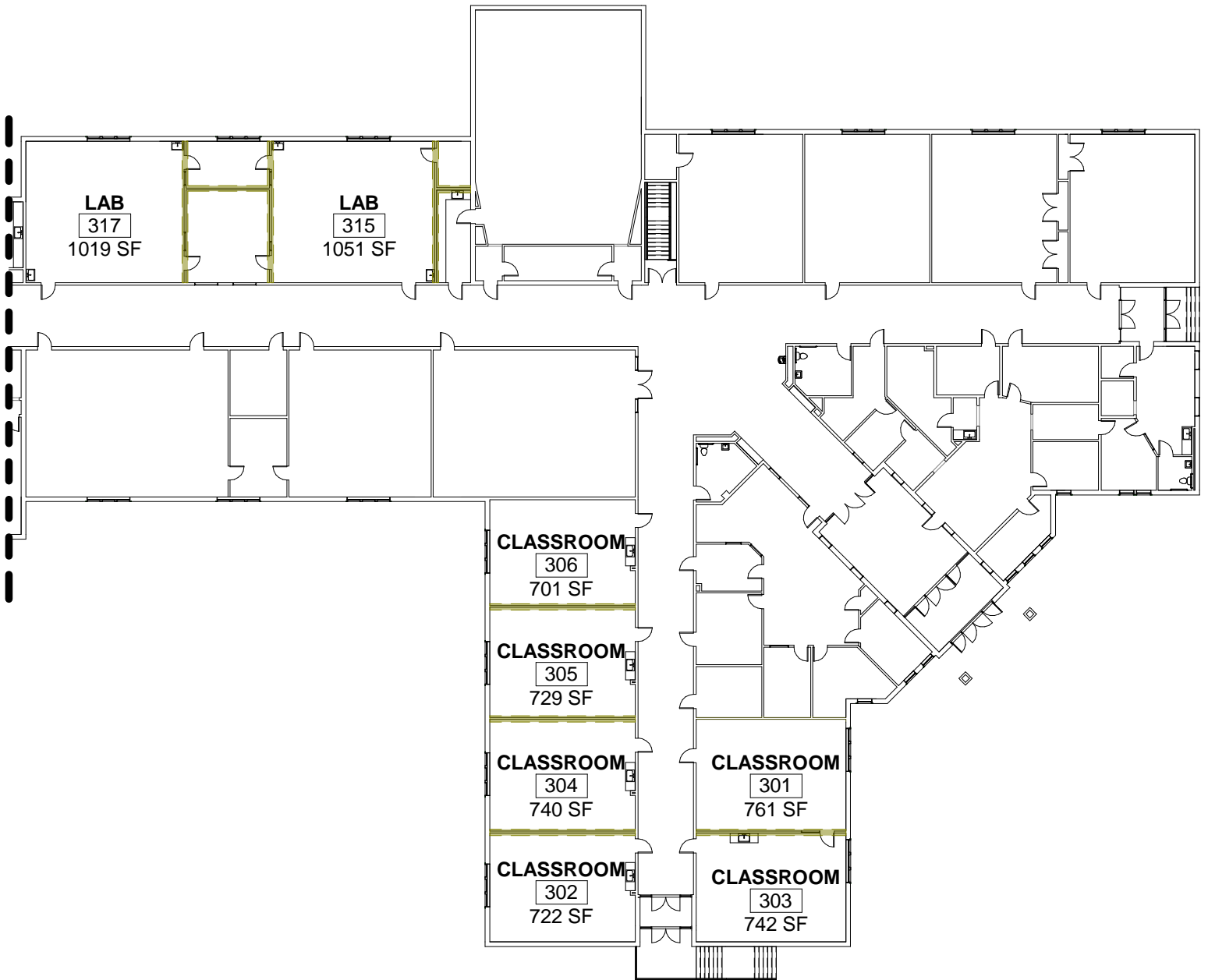

① 3RD FLOOR - D PLAN - DIAGRAM
 1/32" = 1'-0"

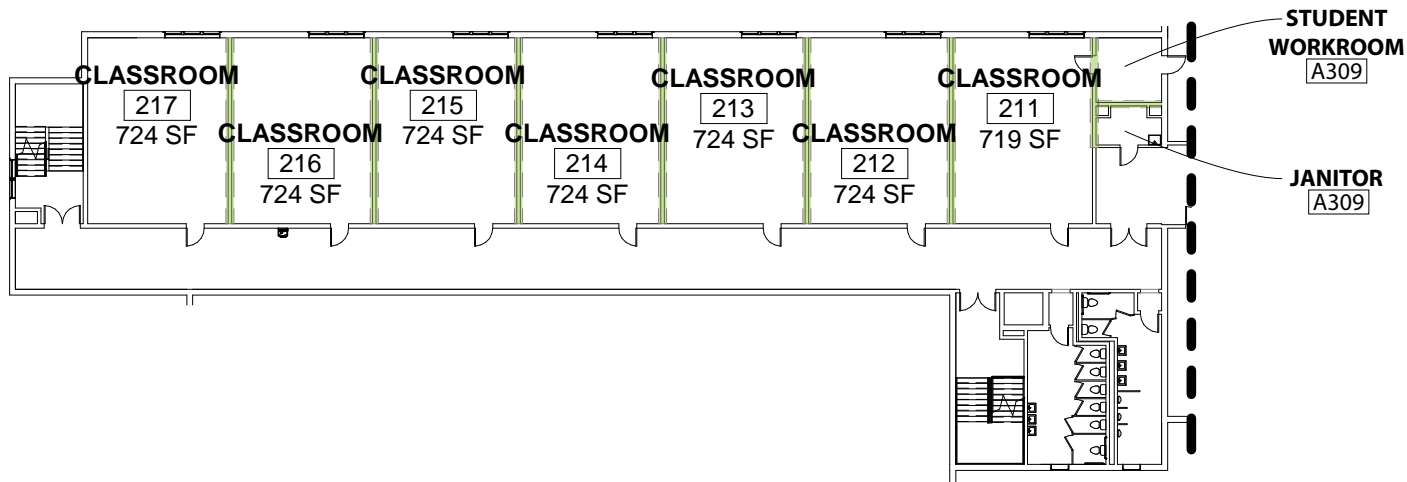

1 2ND FLOOR - E PLAN - DIAGRAM
 1/32" = 1'-0"

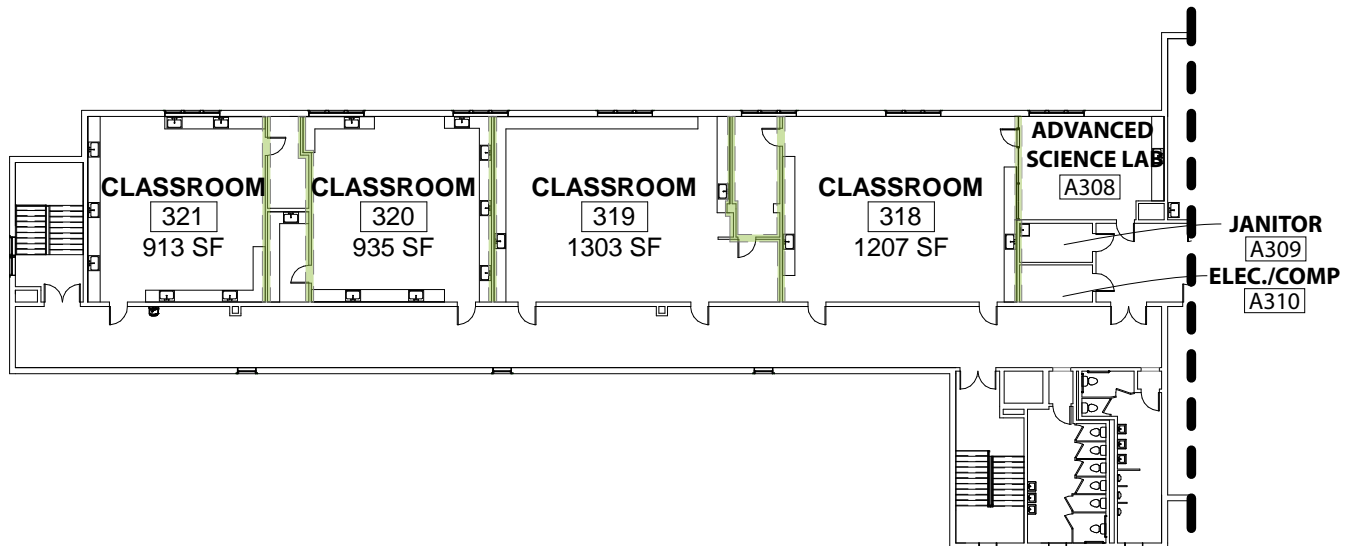

2 3RD FLOOR - E PLAN
 1/32" = 1'-0"

Paint Spray Booth

H-C102-LS-4054				
Priority	Cost			
	\$\$			
Coordination by Discipline				
<input checked="" type="checkbox"/>	<input checked="" type="checkbox"/>	<input checked="" type="checkbox"/>	<input type="checkbox"/>	<input checked="" type="checkbox"/>
A	M	E	P	FP
<input type="checkbox"/>	<input checked="" type="checkbox"/>	<input type="checkbox"/>	<input type="checkbox"/>	<input type="checkbox"/>
S	LS	SC	BE	C

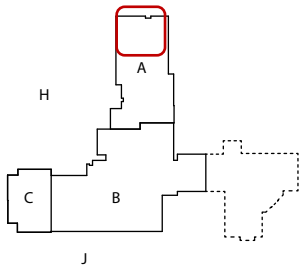

RELATED SCOPES OF WORK

Not Applicable

EXISTING CONDITIONS

Currently there is no space for painting that meets NFPA 33 in the metal workshop space. Residue and odors from spray operations can be both flammable and cause respiratory issues.

Life Safety Code requires a spray booth constructed of noncombustible or limited combustible materials or assemblies. The interior surfaces of the spray area shall be smooth, designed and installed to prevent pockets that can trap residues, and designed to facilitate ventilation and cleaning.

The spray booth must be mechanically exhausted. Ventilation shall be kept in operation at all times while spray operations are being conducted and for a sufficient time thereafter to allow the vapors from drying coated objects or material and residues to be exhausted.

RECOMMENDATIONS

Consult with an A/E team and a spray booth manufacturer to design and implement a NFPA 33-compliant paint spray booth. See plan diagram for one possible location.

- Relocated to wood shop or metal lab

Provide paint booth for painting and non-sprayed coatings operations per NFPA 33 for spray operations of flammable coatings.



Metal workshop

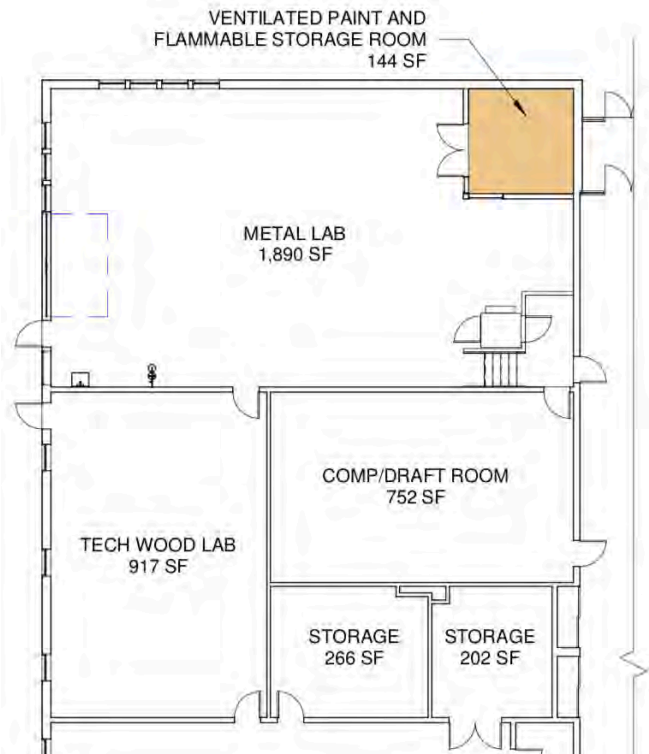

One possible location for paint spray booth.

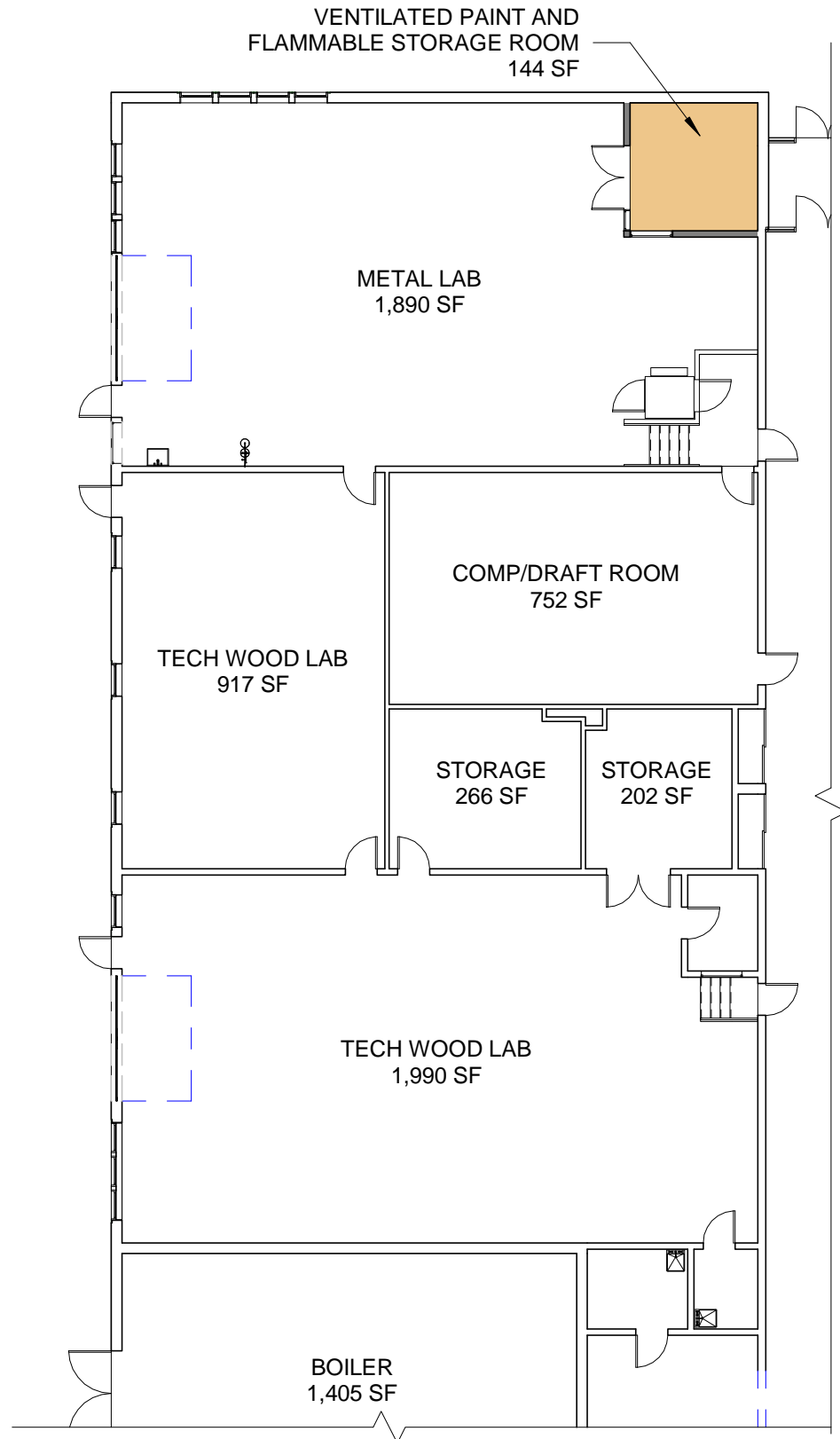

Provide Burglar Bars at Low Louvers

To meet the Maine DoE requirements
Provide in louvers less than 8 ft high

RELATED SCOPES OF WORK

H-ALL-SC-4115

H-ALL-SC-4055	
Priority	Cost
	\$
Coordination by Discipline	
<input checked="" type="checkbox"/>	<input checked="" type="checkbox"/> <input type="checkbox"/> <input type="checkbox"/> <input type="checkbox"/>
A	M E P FP
<input type="checkbox"/> <input type="checkbox"/> <input checked="" type="checkbox"/> <input checked="" type="checkbox"/> <input type="checkbox"/>	
S	LS SC BE C

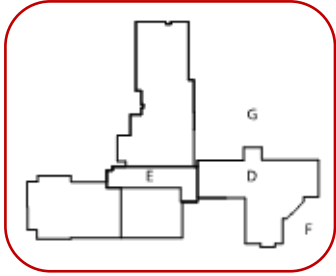

EXISTING CONDITIONS

Some louvers and other outside wall openings are lower than 8 feet above the adjacent grade, and large enough and unobstructed enough for a person to enter. In most cases it would be impractical to relocate the openings.

RECOMMENDATIONS

To meet the intent of the Maine Department of Education's Public School Standards & Guidelines for New School Construction & Major Renovation Projects, provide burglar bars in low openings to prevent entry.



SCOPE OF WORK

Remove ducts from the interior of the wall openings as required. Install burglar bars in the outside wall openings. Reattach ducts.

Energy Recovery for Units with Outdoor Air

Energy use and system capacities can be reduced by recovering exhaust heat

RELATED SCOPE OF WORK

Not Applicable

H-ALL-M-4056				
Priority	Cost			
	\$\$\$\$			
Coordination by Discipline				
<input checked="" type="checkbox"/>	<input checked="" type="checkbox"/>	<input checked="" type="checkbox"/>	<input type="checkbox"/>	<input type="checkbox"/>
A	M	E	P	FP
<input checked="" type="checkbox"/>	<input type="checkbox"/>	<input type="checkbox"/>	<input type="checkbox"/>	<input type="checkbox"/>
S	LS	SC	BE	C

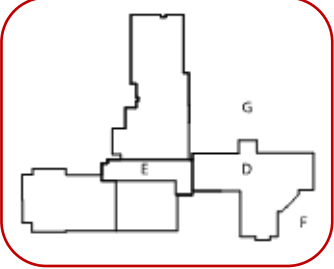

EXISTING CONDITIONS

There are various ages of indoor and roof-mounted air handling units (AHUs), gas-fired rooftop units (RTUs), and unit ventilators (UVs), which provide mixed air at less than 100% outside air; these do not have heat or energy recovery.



RECOMMENDATIONS

The Maine Department of Education Public School Standards and Guidelines for New School Construction & Major Renovation Projects requires energy recovery for air handling systems which provide outdoor air for ventilation. As units are replaced, the replacement units should have energy recovery per the State Energy Code and the applicable edition of the ASHRAE 90.1 energy standard. Energy recovery transfers latent (wet) heat energy and sensible (dry) heat energy from exhaust to incoming air; heat recovery only transfers sensible heat energy. The latent recovery is helpful in most, but not all, applications.

NEXT LEVEL

Retrofit existing air handling systems that are not due for replacement, to provide energy recovery. For example, an existing gas-fired RTU serving a locker room can have an energy-recovery ventilator (ERV) mounted alongside to supply and exhaust the minimum constant ventilation air; in economizer mode the additional outside air would bypass the ERV. A unit ventilator or a group of them might be replaced with a ducted ERV system.

SCOPE OF WORK

1. Base Level: As air handling systems are replaced under other work items, and when replacing them on an as-needed basis, incorporate energy recovery into any replacement air handling system that provides outdoor air for ventilation. Provide additional ductwork, roof and wall openings, space for equipment, structural support, fan power, and electrical power as required. Provide control of the energy recovery, including economizer bypass to reduce or disable the recovery based on room needs as required by the Energy Code. Insulate outside air intake ducts, and indoor exhaust ducts from the energy recovery device to outdoors.
2. Next Level: Retrofit existing air handling systems to add energy recovery.

Provide MERV 13 or MERV 11 filters

Provide MERV 13 or MERV 11 filters on HVAC equipment throughout.

RELATED SCOPES OF WORK

Not Applicable

H-ALL-M-4057				
Priority	Cost			
	\$			
Coordination by Discipline				
<input type="checkbox"/>	<input checked="" type="checkbox"/>	<input type="checkbox"/>	<input type="checkbox"/>	<input type="checkbox"/>
A	M	E	P	FP
<input type="checkbox"/>	<input type="checkbox"/>	<input type="checkbox"/>	<input type="checkbox"/>	<input type="checkbox"/>
S	LS	SC	BE	C

EXISTING CONDITIONS

The majority of the existing HVAC equipment appears to have MERV 8 filters. These filters do not meet the requirements set forth by the Maine Department of Education. It appears that the current maintenance schedule may be too infrequent for the current filtration standards, as there are several filters that appear to have caved in due to excess build up creating significant static pressure; this creates more work for the fans, therefore requiring higher electrical usage.

RECOMMENDATIONS

The Maine Department of Education document *Public School Standards & Guidelines for New School Construction & Major Renovation Projects* lists as “required or recommended” filters with Minimum Efficiency Reporting Value of MERV 13 in HVAC equipment, with a MERV 11 minimum if higher-rated filters are not provided by the unit manufacturer. As HVAC equipment gets replaced, provide filtration to meet this requirement on new equipment. It is not recommended to provide MERV 13 filters for the existing units, as the fans and motors were likely not built to handle the additional static pressure. Also, it is recommended that the maintenance schedule for replacement of filters is modified to a more frequent replacement schedule due to the higher filtration rating, which causes filters to load up faster to the maximum static pressure that the fan can handle; deeper cartridge style final filters, and an additional set of lower-MERV prefilters can extend this time. Filter pressure drop monitoring devices should be provided to alert maintenance staff to the need for filter changes. Maintenance reminders may also be built into the building automation (controls) system.



SCOPE OF WORK

As HVAC equipment gets replaced, provide MERV 13 filters; provide MERV 11 as a minimum if space and/or fan power for MERV 13 filters are not provided by the unit manufacturer. Filters which rely on an electret charge to achieve their rating will lose efficiency more quickly. Wherever possible, filters shall have a MERV-A rating, which is obtained under ASHRAE Standard 52.2 Appendix J without reliance on any electret charge. However, in equipment which is limited to 2-inch filter thickness, filters rated with an electret charge may be used to achieve the MERV ratings. Modify filter maintenance schedules to accommodate the anticipated time before filters are fully loaded with dust. Provide filter pressure drop monitoring devices, and maintenance reminders in the building automation system (BAS).

Replace Unit Ventilators

38 units from 1968, 12 units from 2004.
Units are located throughout the high school.

RELATED SCOPES OF WORK

H-309-M-4096

H-ALL-M-4058	
Priority	Cost
	\$\$\$\$
Coordination by Discipline	
<input checked="" type="checkbox"/>	<input checked="" type="checkbox"/>
<input checked="" type="checkbox"/>	<input type="checkbox"/>
<input checked="" type="checkbox"/>	<input type="checkbox"/>
<input type="checkbox"/>	<input type="checkbox"/>
<input type="checkbox"/>	<input type="checkbox"/>
A	M
E	P
FP	
<input checked="" type="checkbox"/>	<input type="checkbox"/>
<input type="checkbox"/>	<input type="checkbox"/>
<input type="checkbox"/>	<input type="checkbox"/>
<input type="checkbox"/>	<input type="checkbox"/>
S	LS
SC	BE
C	

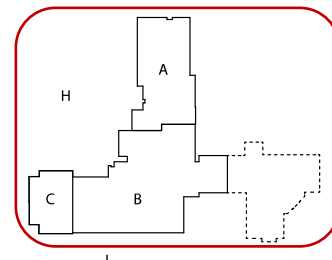

EXISTING CONDITIONS

There are, located throughout the building, 38 Herman Nelson unit ventilators (UVs) installed in 1968, showing significant signs of aging, and are well past their useful life. There are 12 Trane UVs installed in 2004 to replace existing Herman Nelson units; these are nearing the end of their 20-year average life expectancy as well. Many unit ventilators are ineffective at providing adequate heating and ventilation, being not centrally located, and having the flat top used as a storage shelf which inhibits the flow of air; many rooms have further obstructed airflow with cabinets and various tall storage items in front of the units. Many units show signs of rust, dented outlet grilles, damaged exterior louvers, and loose or stuck outside air dampers. Some units have a separation from their louvers, allowing unconditioned outdoor air to enter the space. Some rooms appear to have insufficient air relief grilles to allow ventilation and economizer cooling air to enter the room.

RECOMMENDATIONS

At a minimum as a short-term solution, perform various repairs at each UV, including rust removal and repainting, new grilles, new exterior louvers, new dampers, and re-sealing to wall louvers. A long-term solution would be to provide new UVs, provide relief air systems for rooms where relief is lacking, and rebalance existing relief systems for those that do. Balance outdoor air dampers at each unit ventilator to provide ventilation air per current Code and ASHRAE 62.1 requirements of 10 cfm per person plus 0.12 cfm per square foot.



NEXT LEVEL

Remove unit ventilators and room relief air systems. Provide a fully ducted system with indoor or rooftop air handling units (AHUs), integral exhaust with energy recovery, economizer free cooling, and variable airflow to each room based on occupancy, with ceiling supply and return in classrooms. Ceiling space appears sufficient for ductwork. This would free up classroom floor and wall space. There are several spaces available for indoor air handling units; the Maine Department of Education guidelines recommend indoor rather than rooftop units. Compared to UVs, AHUs would increase usable classroom floor and wall space, reduce room noise and increase comfort for better learning, and reduce operating and maintenance costs.

SCOPE OF WORK

Base Level: For the short-term, perform various repairs. For long-term, provide replacement UVs, wall louvers, and sealed and insulated duct sleeves; reconnect to heating piping; provide new control valves and direct digital (DDC) controls, rebalance water and air flows to current Codes and ASHRAE 62.1 standards.
Next Level: Provide architectural and engineering design services. Remove UVs, louvers, piping, and relief systems. Provide ducted systems, including AHUs with exhaust energy recovery. Provide variable volume control and duct heating coil for each classroom. Provide ceiling distribution in classrooms, and DDC controls for ventilation, economizer cooling, energy recovery, and night setback. Provide structural support and electrical power supplies for AHUs. Provide and patch building openings.

Mechanical Equipment Numbering & Nameplates

Several duplicate equipment numbers
RELATED SCOPES OF WORK
 Not Applicable

H-ALL-M-4059				
Priority	Cost			
	\$			
Coordination by Discipline				
<input type="checkbox"/>	<input checked="" type="checkbox"/>	<input checked="" type="checkbox"/>	<input type="checkbox"/>	<input type="checkbox"/>
A	M	E	P	FP
<input type="checkbox"/>	<input type="checkbox"/>	<input type="checkbox"/>	<input type="checkbox"/>	<input type="checkbox"/>
S	LS	SC	BE	C

EXISTING CONDITIONS

There are currently several pieces of equipment throughout the building with duplicate equipment numbering or no known equipment number. There are several pieces of equipment without nameplates indicating make, model, serial number, and general performance data. Several pieces of equipment include nameplates which are faded or otherwise difficult to read, and some include incomplete data. Many items have duplicate serial numbers.

RECOMMENDATIONS

Provide a building-wide mechanical equipment numbering scheme such that no two items receive the same number. Provide riveted engraved acrylic nameplates affixed to each piece of equipment bearing the unit number, make, model, serial number, and general performance. Install nameplates such that dismantling of equipment is not necessary to view the nameplate in full. Recommend including all pieces of HVAC equipment including unit ventilators, exhaust fans, unit heaters, air handling units, and any other piece of equipment serving the HVAC systems.

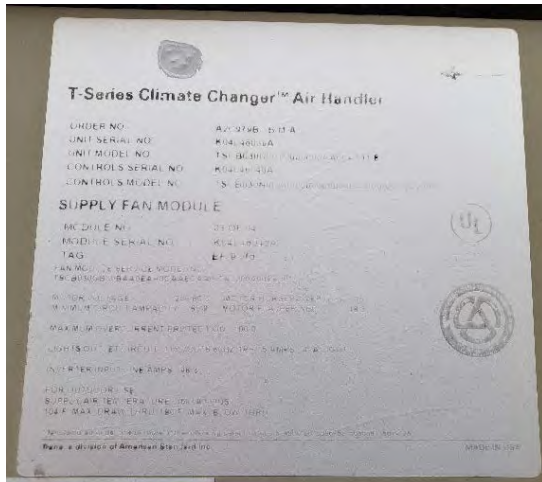

SCOPE OF WORK

Provide a building-wide mechanical equipment numbering scheme such that no two items receive the same number. Provide riveted engraved acrylic nameplates affixed to each piece of equipment bearing the unit number, make, model, serial number, and general performance. Coordinate updated numbering scheme with maintenance staff. Provide complete drawings indicating updated numbering scheme. Coordinate this work item with mechanical equipment replacement work items.

Provide Exhaust at Copier-Printers

Lack proper ventilation per Code
May require additional exhaust fans

RELATED SCOPES OF WORK

Not Applicable

H-ALL-M-4060					
Priority	Cost				
	\$				
Coordination by Discipline					
<input checked="" type="checkbox"/>	<input checked="" type="checkbox"/>		<input checked="" type="checkbox"/>	<input type="checkbox"/>	<input type="checkbox"/>
A	M		E	P	FP
<input type="checkbox"/>	<input type="checkbox"/>	<input type="checkbox"/>	<input type="checkbox"/>	<input type="checkbox"/>	
S	LS	SC	BE	C	

EXISTING CONDITIONS

Copiers and printers generally do not have local exhaust to remove fumes and odors, as required by current Codes.



RECOMMENDATIONS

Provide local exhaust with a grille above any copiers and printers, to comply with International Mechanical Code (IMC) 2015, Chapter 4 Ventilation, Table 403.3.1.1 for copy and printing rooms. Duct to existing exhaust systems when suitable and having available capacity. Provide additional exhaust fans where necessary.

SCOPE OF WORK

Provide ceiling or wall exhaust grilles or registers. Provide exhaust ductwork to exhaust fans. Where it is necessary to add exhaust fans, provide outdoor terminations such as wall louvers or roof hoods, building penetrations, and electrical power. Provide controls to operate the fans continuously during occupied hours, including during nearby zone overrides.

Provide Cooling for Summer Programs

Most student spaces lack AC
Summer school a growing need

RELATED SCOPES OF WORK

H-D103-M-4071

H-ALL-M-4061	
Priority	Cost
	\$\$\$
Coordination by Discipline	
<input checked="" type="checkbox"/>	<input checked="" type="checkbox"/>
<input checked="" type="checkbox"/>	<input checked="" type="checkbox"/>
<input checked="" type="checkbox"/>	<input checked="" type="checkbox"/>
<input checked="" type="checkbox"/>	<input checked="" type="checkbox"/>
<input type="checkbox"/>	<input type="checkbox"/>
A	M
E	P
FP	
<input checked="" type="checkbox"/>	<input type="checkbox"/>
<input type="checkbox"/>	<input type="checkbox"/>
<input type="checkbox"/>	<input type="checkbox"/>
<input type="checkbox"/>	<input type="checkbox"/>
S	LS
SC	BE
C	

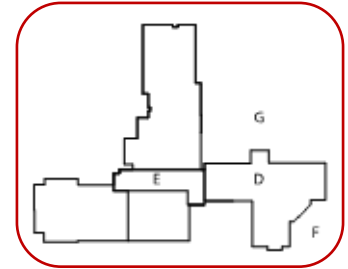

EXISTING CONDITIONS

Most of the rooms used by students do not have air conditioning or dehumidification. Summer school and similar programs for children and others are a growing need and interest in the community. Summer weather has trended hotter and more humid in recent years. In addition to the comfort concerns, uncontrolled humidity can damage building materials and other items. The Maine Department of Education Public School Standards and Guidelines for New School Construction & Major Renovation Projects lists as “required or recommended” air conditioning in spaces used year-round such as auditoriums, and spaces needed for summer school programs. It also recommends (as a premium) dehumidification systems for summer use in general areas, and specialized dehumidification systems for gymnasiums with wood floors.

RECOMMENDATIONS

Provide air conditioning in spaces used year-round including auditoriums, and in spaces for summer programs. Provide dehumidification in gymnasiums with wood floors.

SCOPE OF WORK

Provide engineering and architecture services. Remove HVAC equipment and ductwork that is not suitable for air conditioning. Provide air-conditioning systems and dehumidification, and associated ductwork and piping. Where possible, provide air-conditioning systems with 100%-outside-air economizer cooling capability, which some systems such as ductless split systems are not capable of. Provide digital controls connected to the building central control system. Provide structural supports and modifications, building openings and flashing, and electrical power supplies.

Increase Ventilation for Improved IAQ

Increase to or above current Codes
May reduce student and staff illness

RELATED SCOPES OF WORK

Not Applicable

H-ALL-M-4062				
Priority	Cost			
	\$\$\$			
Coordination by Discipline				
<input checked="" type="checkbox"/>	<input checked="" type="checkbox"/>	<input checked="" type="checkbox"/>	<input type="checkbox"/>	<input type="checkbox"/>
A	M	E	P	FP
<input type="checkbox"/>	<input type="checkbox"/>	<input type="checkbox"/>	<input type="checkbox"/>	<input type="checkbox"/>
S	LS	SC	BE	C

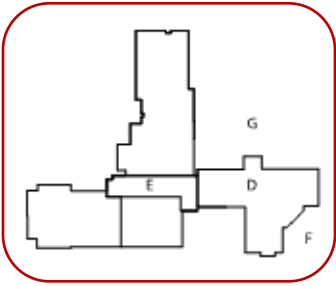

EXISTING CONDITIONS

Existing ventilation systems were designed to the ventilation Codes of their time. Codes and other standards have increased their requirements and recommendations for quantities of outside air supply, and requirements for good distribution of the air for ventilation effectiveness.



RECOMMENDATIONS

Comply with the Maine Department of Education’s Public School Standards & Guidelines for New School Construction & Major Renovation Projects. Increase outside air supply quantities to occupied spaces, to levels at or above current Codes and standards. Modify distribution of air to ensure it is effectively distributed to the occupants’ breathing zone. Provide energy recovery where practical, and increased heating (and cooling, where applicable) to the supply airstream as necessary.

SCOPE OF WORK

Provide design and testing services to verify existing outside airflows, both as designed and as currently operating. Compare these to current Codes and standards. Provide equipment and ductwork as required to achieve increased outside airflows where required. Provide modifications or replacements of supply terminal diffusers and registers to distribute the air to the occupants in the most effective and efficient manner. Provide additional exhaust and relief to outdoors as required for proper building pressurization. Provide energy recovery where practical, and increased heating (and cooling, where applicable) to the supply airstream as necessary. Provide architectural modifications such as roof penetrations and supports as required. Provide electrical power and controls as necessary.

Provide Full Commissioning of HVAC Systems

Verify and repair system operations

RELATED SCOPES OF WORK

Not Applicable

H-ALL-M-4063				
Priority	Cost			
	\$\$\$			
Coordination by Discipline				
<input type="checkbox"/>	<input checked="" type="checkbox"/>	<input checked="" type="checkbox"/>	<input checked="" type="checkbox"/>	<input type="checkbox"/>
A	M	E	P	FP
<input type="checkbox"/>	<input type="checkbox"/>	<input type="checkbox"/>	<input type="checkbox"/>	<input type="checkbox"/>
S	LS	SC	BE	C

EXISTING CONDITIONS

The Maine Department of Education Public School Standards and Guidelines for New School Construction & Major Renovation Projects lists commissioning as “required or recommended.” Commissioning is a relatively new field, and likely was not part of the previous construction. As systems age, re-commissioning of existing systems and controls can be beneficial to make them operate as well as possible, and to discover and identify existing operational and issues that are in need of further repairs. This leads to more effective HVAC systems, lower energy costs, and improved indoor air quality.

Commissioning is a process of testing systems to demonstrate that they operate as designed. Control sequences are confirmed by direct observation of items such as control valves and dampers.



RECOMMENDATIONS

Commission and re-commission building systems.

SCOPE OF WORK

In accordance with the Maine Department of Education Public School Standards and Guidelines for New School Construction & Major Renovation Projects, hire a 3rd party agent to perform commissioning. Enhanced commissioning should be done after occupancy to monitor systems performance. Systems to be commissioned per the DoE include: heating ventilation and cooling (HVAC), controls, lighting and power loads, and air barrier systems (applicable to newly constructed building exterior walls). Also commission plumbing systems with controls, such as water heating and circulation.

Provide Increased Library Cooling

Library cooling system seems insufficient; floor fans added

RELATED SCOPES OF WORK

Not Applicable

H-220-M-4064				
Priority	Cost			
	\$\$			
Coordination by Discipline				
<input checked="" type="checkbox"/>	<input checked="" type="checkbox"/>		<input checked="" type="checkbox"/>	<input type="checkbox"/>
A	M	E	P	FP
<input type="checkbox"/>	<input type="checkbox"/>	<input type="checkbox"/>	<input type="checkbox"/>	<input type="checkbox"/>
S	LS	SC	BE	C

EXISTING CONDITIONS

It appears that the cooling is insufficient; as noted in Appendix C, stakeholder meeting notes state that library remains too warm/hot despite having some air circulation. There are ceiling diffusers widely spaced across the library ceiling, but it seems the majority of the air is supplied and returned in the sidewall at one side of this wide, low room. Occupants in the summer were using portable floor fans to provide additional air movement near the people. Several computers were running in the room.



RECOMMENDATIONS

Provide a combination of additional air movement, air conditioning, and/or dehumidification to meet the space needs. Benefits will include improved occupant comfort, and better environment for the storage of library materials.

SCOPE OF WORK

Provide engineering analysis to determine needs and best solutions in cooperation with the users of the space. Replace or add equipment as required. Provide additional ductwork and piping as required. Provide additional and/or increased electrical power supplies as required.

Cape Elizabeth Schools Needs Assessment

Provide Cooling to Life Skills Room

Room is used for summer classes
Does not have cooling

RELATED SCOPES OF WORK

H-202-A-4014

H-202-M-4065					
Priority	Cost				
	\$				
Coordination by Discipline					
<input checked="" type="checkbox"/>	<input checked="" type="checkbox"/>		<input checked="" type="checkbox"/>	<input type="checkbox"/>	<input type="checkbox"/>
A	M		E	P	FP
<input type="checkbox"/>	<input type="checkbox"/>	<input type="checkbox"/>	<input type="checkbox"/>	<input type="checkbox"/>	
S	LS	SC	BE	C	

EXISTING CONDITIONS

The Maine Department of Education Public School Standards and Guidelines for New School Construction & Major Renovation Projects lists as “required or recommended” cooling for spaces used for summer classes.

RECOMMENDATIONS

Provide air conditioning.

SCOPE OF WORK

Provide architectural and engineering design services. Provide an air conditioning system. Coordinate installation and controls with existing ventilation and heating systems. Provide ductwork, piping, controls, building penetrations with firestopping, supports, and electrical power supplies as required.

Provide Additional Heat to Front Office Staff

Heating is reportedly inadequate
Individuals needs vary

RELATED SCOPES OF WORK

Not Applicable

H-D-M-4066				
Priority	Cost			
	\$\$			
Coordination by Discipline				
<input checked="" type="checkbox"/>	<input checked="" type="checkbox"/>		<input checked="" type="checkbox"/>	<input type="checkbox"/>
A	M	E	P	FP
<input type="checkbox"/>	<input type="checkbox"/>	<input type="checkbox"/>	<input type="checkbox"/>	<input type="checkbox"/>
S	LS	SC	BE	C

EXISTING CONDITIONS

Front office staff report that heating in their rooms is inadequate. Individuals' needs vary, so appropriate zoning of heating is needed.



RECOMMENDATIONS

Provide supplemental hydronic (hot water) heating to the rooms.

SCOPE OF WORK

Provide engineering services to determine space and zoning needs in cooperation with the users. Provide additional hydronic heating to meet the quantity of heat required for each space, and additional zones of control to provide sufficient temperature setpoint variations to satisfy the occupants to the extent practical (it is not usually necessary to provide each person their own zone). Provide hydronic heating in such forms as additional duct coil capacity to heat the overhead supply air, and space heating such as fin tube radiation or overhead radiant ceiling panels. Provide hydronic piping and insulation, and upgrade piping mains as required for the additional water flows. Provide controls including control valves and DDC wall-mounted sensors with controllers and wiring. Provide modifications to building finishes and furnishings as necessary.

Cape Elizabeth Schools Needs Assessment

Provide HVAC to Theater Costume Storage

Lacks HVAC air movement
Musty unpleasant smelling

RELATED SCOPES OF WORK

H-AB-A-4029

H-C131-M-4067				
Priority	Cost			
	\$			
Coordination by Discipline				
<input checked="" type="checkbox"/>	<input checked="" type="checkbox"/>		<input checked="" type="checkbox"/>	<input type="checkbox"/>
A	M	E	P	FP
<input type="checkbox"/>	<input type="checkbox"/>	<input type="checkbox"/>	<input type="checkbox"/>	<input type="checkbox"/>
S	LS	SC	BE	C

EXISTING CONDITIONS

Room lacks HVAC air movement, and has an unpleasant musty, mold-like odor.

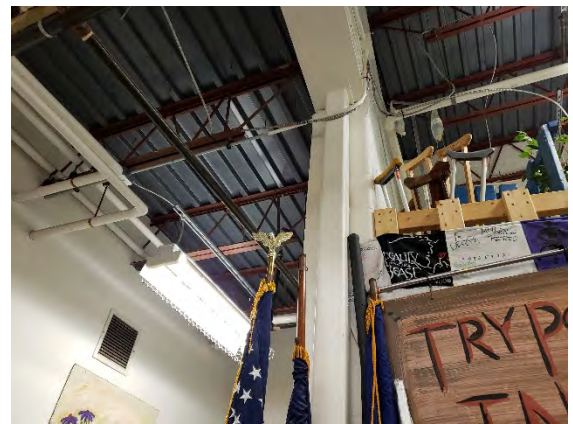

RECOMMENDATIONS

Provide additional supply and return or exhaust ventilation, arranged to effectively circulate air in the room. Remove and clean or dispose of theatrical props and other materials which have absorbed or caused the odors.

NEXT LEVEL

Provide dehumidification.

SCOPE OF WORK

1. Base Level: Provide ductwork and fan systems as required to provide adequate ventilation. Provide additional fan capacity as required. Provide room openings for ductwork. Provide power supplies as necessary.
2. Next Level: Provide a dehumidifier, with permanent pumped drain to an indirect waste receiver. Provide power supply.

Cape Elizabeth Schools Needs Assessment

Provide Increased Ventilation

Student workroom lacks ventilation suited to room activities

RELATED SCOPES OF WORK

Not Applicable

H-A208-M-4068		
Priority	Cost	
	\$	
Coordination by Discipline		
<input checked="" type="checkbox"/>	<input checked="" type="checkbox"/> <input type="checkbox"/> <input type="checkbox"/> <input type="checkbox"/>	
A	M E P FP	
<input type="checkbox"/>	<input type="checkbox"/> <input type="checkbox"/> <input type="checkbox"/> <input type="checkbox"/> <input type="checkbox"/>	
S	LS SC BE C	

EXISTING CONDITIONS

Room lacks ventilation. Adjacent classroom has a unit ventilator which cannot be ducted to this room.

RECOMMENDATIONS

Provide supply air ventilation from a nearby ducted system.

NEXT LEVEL

Provide ventilation as part of a replacement of the unit ventilators with central ventilation systems.

SCOPE OF WORK

Provide ductwork and supply diffuser or grille. Provide a duct hydronic (hot water) heating coil if necessary to temper the supply air to room temperature. Provide building penetrations as required.

Provide Room Sensors with Occupant Adjustment

Most room controls have blank covers
Adjustment can improve satisfaction

RELATED SCOPES OF WORK

Not Applicable

H-ALL-M-4069					
Priority	Cost				
	\$\$				
Coordination by Discipline					
<input checked="" type="checkbox"/>	<input checked="" type="checkbox"/>		<input checked="" type="checkbox"/>	<input type="checkbox"/>	<input type="checkbox"/>
A	M		E	P	FP
<input type="checkbox"/>	<input type="checkbox"/>		<input type="checkbox"/>	<input type="checkbox"/>	<input type="checkbox"/>
S	LS	SC	BE	C	

EXISTING CONDITIONS

The Maine Department of Education Public School Standards and Guidelines for New School Construction & Major Renovation Projects lists as “required or recommended” individual room controls, including the use of operable windows. Most of the existing occupied rooms have operable windows. In the rooms that have DDC (direct digital control) room temperature control, most of the wall-mounted sensors has blank covers with no occupant-accessible settings. Occupants may want to adjust the sensors’ temperature setpoints to coordinate with their use of the space and the windows, as well as their personal comfort needs.



RECOMMENDATIONS

Provide occupant adjustable wall-mounted room DDC temperature sensors, with user temperature adjustment dials or sliders, programmed in the DDC system to limit ranges of adjustment and to reset them each day.

SCOPE OF WORK

Modify controls in rooms where occupant adjustment is desired. In rooms with DDC sensors, remove existing blank-cover DDC sensors, and provide sensors with occupant adjustment devices; replace or augment any incompatible wiring and controllers as necessary. In occupied rooms which don’t yet have DDC, remove the wall thermostats, provide DDC wall sensors, controllers, and compatible wiring, and provide programming.

Separate Ventilation for School Lockers

School and Pool lockers share systems
School lockers have pool odors

RELATED SCOPES OF WORK

H-B-A-4022

H-D114-M-4070				
Priority	Cost			
	\$\$\$			
Coordination by Discipline				
<input checked="" type="checkbox"/>	<input checked="" type="checkbox"/>	<input checked="" type="checkbox"/>	<input checked="" type="checkbox"/>	<input type="checkbox"/>
A	M	E	P	FP
<input checked="" type="checkbox"/>	<input type="checkbox"/>	<input type="checkbox"/>	<input type="checkbox"/>	<input type="checkbox"/>
S	LS	SC	BE	C

EXISTING CONDITIONS

The locker rooms for both the high school and the attached Community Pool share a common ventilation system. As a result, the humidity and odors such as chlorine from the pool enter into the high school locker rooms. The rooftop units AHU-9 and EF-9, built in 1995, are separate units for supply and exhaust. The units have coil piping vestibules; they may have runaround coils for heat recovery.



RECOMMENDATIONS

Provide separate ventilation systems for both sets of locker rooms.

SCOPE OF WORK

Provide engineering and architectural services to determine requirements in cooperation with the building users. Remove ventilation central equipment. Remove existing ductwork, and provide new ductwork, as necessary to enable connections to new central ventilation equipment. Provide central ventilation equipment, likely installed on the roof. Provide structural modifications to support the equipment. Provide building penetrations and flashing as required. Provide electrical power and controls as required.

Cape Elizabeth Schools Needs Assessment

Provide humidity control for Gym

Wood floor warps due to seasonal fluctuations in space humidity level

RELATED SCOPES OF WORK

H-ALL-M-4061

H-D103-M-4071				
Priority	Cost			
	\$\$			
Coordination by Discipline				
<input checked="" type="checkbox"/>	<input checked="" type="checkbox"/>		<input checked="" type="checkbox"/>	<input checked="" type="checkbox"/>
A	M	E	P	FP
<input type="checkbox"/>	<input type="checkbox"/>	<input type="checkbox"/>	<input type="checkbox"/>	<input type="checkbox"/>
S	LS	SC	BE	C

EXISTING CONDITIONS

Floors warp seasonally with humidity fluctuations. Rooftop-mounted HVAC systems built in October 2016 are gas-fired packaged rooftop units with air conditioning, but do not provide adequate control of humidity.

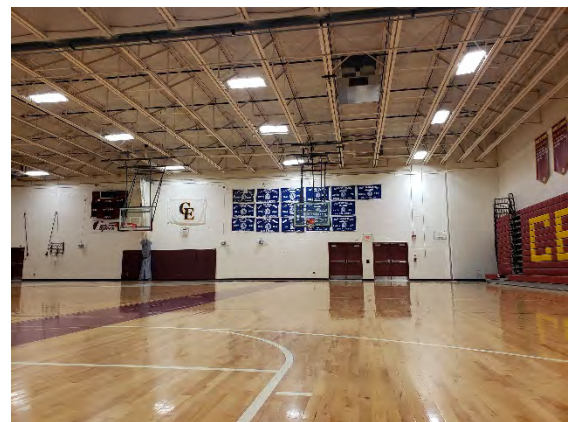

RECOMMENDATIONS

Provide additional humidity control, including dehumidification for summer and humidification for winter.

SCOPE OF WORK

Provide engineering and architectural services to design the systems, in cooperation with the building users. Remove and modify existing equipment as necessary to accommodate installation of dehumidification and humidification. It may be possible to modify the existing equipment to allow hot-gas reheat to handle some of the dehumidification requirements. Provide additional equipment as necessary. Provide additional controls including room humidity sensors, and CO2-based control of ventilation to regulate and potentially reduce the flow of outside air to the space. Provide support and penetrations for equipment and piping. Provide electrical power supplies.

Mech B216 Equipment Replacement - HVAC

Equipment at or past end of life
Hazardous abatement required

RELATED SCOPES OF WORK

- H-B216-M-4086
- H-B216-M-4089
- H-B216-M-4091
- H-B216-M-4092
- H-B216-P-4108

H-B216-M-4073				
Priority	Cost			
	\$\$\$			
Coordination by Discipline				
<input checked="" type="checkbox"/>	<input checked="" type="checkbox"/>	<input checked="" type="checkbox"/>	<input type="checkbox"/>	<input checked="" type="checkbox"/>
A	M	E	P	FP
<input checked="" type="checkbox"/>	<input type="checkbox"/>	<input type="checkbox"/>	<input type="checkbox"/>	<input type="checkbox"/>
S	LS	SC	BE	C

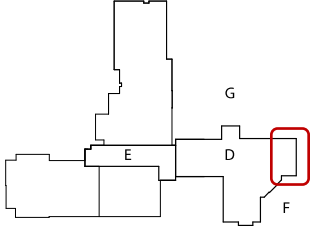

EXISTING CONDITIONS

Mechanical Room B216 is approximately 4,600 square feet, and contains the building domestic water and sprinkler water service entrances. HVAC equipment is beyond its useful life, including 2 heating and ventilating units (HV) with hydronic heating coils, several zone heating coils in branch ducts, a return fan, and a large general exhaust fan. Acoustic treatment is simply hard rubber isolators under HVs and fans. The air handling systems bring in outside air and exhaust air to the outdoors through 2 large wall louvers. The space is heated by a hydronic unit heater, and has a propeller-type wall exhaust fan to outdoors. Much of the large ductwork runs low with exposed reinforcements with sharp edges. Duct insulation is old, with torn jacketing in many places. Heating piping has several leaky and corroded valves and unions. Water flow-setting valves are an old type that may have an adjustment screw but no way to read the flow. There is at least one "Asbestos Danger" tag on ductwork. The space is also used for stored or abandoned furniture, equipment, and materials, making service and navigation through the space challenging.



RECOMMENDATIONS

Mechanical Room B216: Provide new HV-3 & 4, main return fan and exhaust fan, and space unit heater. Provide new duct zone heating coils or equivalent. Replace all hydronic piping to eliminate worn-out valves, fittings, and insulation. Modify layout to improve both equipment service access and school's storage. Remove unnecessary storage and consolidate the rest. Perform hazardous materials survey prior to any work, and abate any hazardous materials which could possibly be disturbed, to avoid hazards to workers and building occupants.

SCOPE OF WORK

Perform a hazardous materials survey and abatement prior to any work in this room. Remove and discard as much stored and abandoned items as possible. Provide new HV-3 & 4 with hydronic heating coils, MERV 13 filters, and spring isolators; consider need for air conditioning. Replace all ductwork associated with these systems. Provide new return fan and main exhaust fan associated with HVs, and unit heater. Consider variable speed drives. Consider adding transfers for makeup air for the room exhaust fan. Provide new duct zone heating coils or equivalent means of controlling zone temperatures. Modify equipment and duct layout to improve equipment service access and school's storage; provide wire cages to limit storage areas and create marked service paths. Reinsulate ducts; pad low edges and mark with warning tape for safety. Provide new insulated hydronic heating piping and valves throughout the room. Balance air and water flows. Provide DDC controls with BACnet for new equipment. Provide power supplies. Modify sprinkler system for new equipment and duct layout.

Cape Elizabeth Schools Needs Assessment

Increase HVAC to Robotics Lab

Increase ventilation and cooling
Used for summer classes

RELATED SCOPES OF WORK

Not Applicable

H-B306-M-4074				
Priority	Cost			
	\$\$			
Coordination by Discipline				
<input checked="" type="checkbox"/>	<input checked="" type="checkbox"/>	<input checked="" type="checkbox"/>	<input type="checkbox"/>	<input type="checkbox"/>
A	M	E	P	FP
<input type="checkbox"/>	<input type="checkbox"/>	<input type="checkbox"/>	<input type="checkbox"/>	<input type="checkbox"/>
S	LS	SC	BE	C

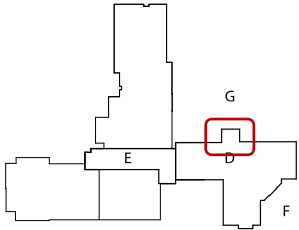

EXISTING CONDITIONS

The Maine Department of Education Public School Standards and Guidelines for New School Construction & Major Renovation Projects requires or recommends cooling for spaces used for summer classes. The Robotics Lab is used for summer classes but does not have sufficient cooling.

RECOMMENDATIONS

Provide air conditioning, and increased ventilation as necessary for the population and use.

SCOPE OF WORK

Provide an air conditioning system. Coordinate with existing ventilation and heating systems. Provide ductwork, piping, controls, building penetrations with firestopping, supports, and electrical power as required. Increase and rebalance ventilation as required for the occupancy.

Additional Heat and Ventilation for Art Room

Has minimal existing heating.
Art Storage and Kiln need ventilation.

RELATED SCOPES OF WORK

Not Applicable

H-A110-M-4075					
Priority	Cost				
	\$				
Coordination by Discipline					
<input checked="" type="checkbox"/>	<input checked="" type="checkbox"/>		<input checked="" type="checkbox"/>	<input type="checkbox"/>	<input type="checkbox"/>
A	M		E	P	FP
<input type="checkbox"/>	<input type="checkbox"/>	<input type="checkbox"/>	<input type="checkbox"/>	<input type="checkbox"/>	
S	LS	SC	BE	C	

EXISTING CONDITIONS

Ceramics/Art Room A110 has only one small heating unit, located on the north interior partition adjacent to the door out to Vestibule A111, not located to heat the exterior wall and three windows effectively. The unit is obstructed by shelving and miscellaneous storage. Below-grade and exposed portions of the exterior wall lose heat; the vestibule is a source of cold air as well. The room is frequently colder than desired setpoints during winter months.

Ceramics/Art Room A110 also lacks ventilation, with only a single central grille of uncertain function, and floor fans to provide some air movement. The operable windows are small, and not reachable for use by teachers. A110 seems stuffy, and has a lot of art materials that potentially give off fumes and odors. The adjacent Art Storage A109 also lacks ventilation, and its only door opens to Art A110. Kiln A135 has 2 kilns with exhaust hoods to exhaust heat and general room air upward from the kilns, but has no makeup air, and its only door opens to Art A110.

These rooms are used for summer school, but have no air conditioning.



RECOMMENDATIONS

Provide additional heating in the Ceramics/Art room. The recommended type is hydronic fintube radiation (with sloped top to prevent storage and sitting/standing) the full length of the outside wall below the windows. Provide ventilation in the 3 rooms: supply and return in Ceramics/Art, supply in Storage, and transfer grilles for makeup to Kiln Room. Consider the need for air conditioning.

SCOPE OF WORK

Perform heat load and ventilation calculations. Provide slope-top style fintube along the exterior wall of Ceramics/Art A110. Provide ventilation such as an energy recovery ventilator, which would require ductwork, intake and exhaust louvers, and a supply-air hot water duct coil. Provide hot water piping to fintube and duct coil. Provide transfer ducts and grilles sized to ensure full flow of the kiln exhaust hoods. If kiln rooms have been hot in spite of the hoods, consider adding a general room exhaust fan ducted to outdoors. Provide DDC controls. Provide architectural openings in partitions and outside wall, and pipe chase to hide piping drops to the fintube. Provide electrical power to ventilation. Consider providing air conditioning, such as ductless split systems with wall mounted units in Ceramics/Art A110.

Replace Boiler Room Pumps

4 end suction pumps

RELATED SCOPES OF WORK

Not Applicable

H-C115-M-4076				
Priority	Cost			
	\$\$			
Coordination by Discipline				
<input type="checkbox"/>	<input checked="" type="checkbox"/>	<input checked="" type="checkbox"/>	<input type="checkbox"/>	<input type="checkbox"/>
A	M	E	P	FP
<input checked="" type="checkbox"/>	<input type="checkbox"/>	<input type="checkbox"/>	<input type="checkbox"/>	<input type="checkbox"/>
S	LS	SC	BE	C

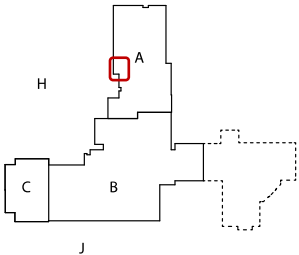

EXISTING CONDITIONS

Four end suction pumps serve the hot water system and are located in boiler room C115. The existing units utilize 20 hp motors and include flexible braided hose connections to piping. No pipe supports are included for the vertical portion connecting each pump to the circulation piping, and significant compression is evident in the flexible braided hose portions, indicating additional support is necessary. The pumps show significant aging and are likely nearing the end of their useful life.

RECOMMENDATIONS

Replace each of four end suction pumps in kind, and replace their flexible piping connectors. Provide supports to take the weight of piping off the flexible connectors, to prevent compressing the connectors and prevent bearing any piping weight on the pumps.



SCOPE OF WORK

Replace each of four end suction pumps in kind, and provide new flexible piping connectors. Provide supports to bear the weight of the piping and prevent compression of the flexible connectors. Install flexible connectors in neutral position for maximum effectiveness of vibration isolation and allowance for expansion and contraction. Replace the aging valves located within the assembly pictured above.

Provide Metal Dust Collection System

Metal Lab lacks dust capture
Metals harmful, can be explosive

RELATED SCOPES OF WORK

Not Applicable

H-C100-M-4077						
Priority	Cost					
	\$\$					
Coordination by Discipline						
<input checked="" type="checkbox"/>	<input checked="" type="checkbox"/>					
A	M	E	P	FP		
<input type="checkbox"/>	<input type="checkbox"/>	<input type="checkbox"/>	<input type="checkbox"/>	<input checked="" type="checkbox"/>		
S	LS	SC	BE	C		

EXISTING CONDITIONS

The Metal Lab has metals machining equipment that can produce hazardous dust into the room and the air students breathe. Unlike the Wood Lab, the equipment does not have a dust collection system to capture the dust and filter the air.

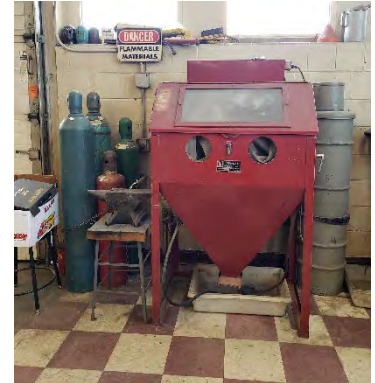

RECOMMENDATIONS

Provide a system of metal dust collection, separate from the wood lab dust collection, with outdoor separation and storage, fire prevention devices, and accessories.

SCOPE OF WORK

Provide outdoor concrete support pad. Provide metal dust collector on support pad. Provide ductwork with connections to equipment, floor sweeps, and other accessories. Provide building penetrations. Provide electrical power and control wiring.

Storage of Compressed Gas Tanks

Tanks throughout room poorly chained
May require containment

RELATED SCOPES OF WORK

Not Applicable

H-C100-M-4078				
Priority	Cost			
	\$\$			
Coordination by Discipline				
<input checked="" type="checkbox"/>	<input checked="" type="checkbox"/>	<input type="checkbox"/>	<input type="checkbox"/>	<input checked="" type="checkbox"/>
A	M	E	P	FP
<input type="checkbox"/>	<input checked="" type="checkbox"/>	<input type="checkbox"/>	<input type="checkbox"/>	<input type="checkbox"/>
S	LS	SC	BE	C

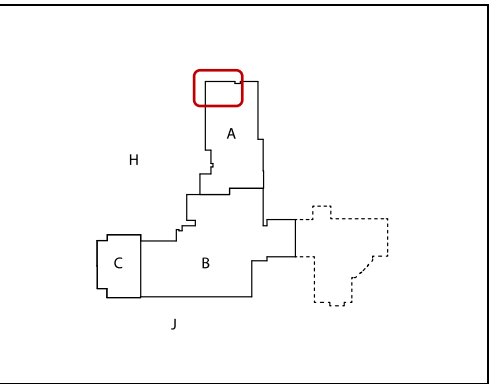

EXISTING CONDITIONS

There are several tanks of various compressed gases in various locations throughout the Metal Lab, including Acetylene, Argon, Argon/CO2 blend, Nitrogen, and Oxygen. A group on the wall has a low loose chain. One tank at a bench has no chain. Some are on carts. An overhead door could allow entry of motor vehicles.



RECOMMENDATIONS

Provide proper support chains or belts to prevent a tank from tipping over and breaking its top valve. Consider the use of insulated chains or non-conductive belts, as well as wall brackets and cylinder stands manufactured for this purpose. Consider securing each cylinder separately, to prevent other cylinders from falling when items are removed from storage, and so that the height of support is suitable for each tank's height. Store oxygen and fuel gas cylinders with proper separation (space or rated barrier) from each other. Store cylinders separated from flammable and combustible liquids and from materials that ignite easily, to prevent potential increase in pressure due to heat of fire. Store cylinders away from work areas so that sparks, hot slag, or flame will not reach them; when this is impractical, provide fire resistant shielding. Store cylinders away from means of egress and electrical panels. Protect from vehicular damage.

NEXT LEVEL

Provide fire-rated and ventilated storage, separated from the work space.

SCOPE OF WORK

Base Level: Provide support and protective devices for each tank. Separate tanks by type, and from other hazards. Provide instructional signage at each tank location to indicate proper storage methods and hazards. Post procedural instructions in durable clearly-written format. Provide a hand truck designed for cylinder transport for safe movement of cylinders. Comply with OSHA regulations found in 29 CFR 1910.101 and in subsequent chapters specific for gas types, NFPA standards such as NFPA-1 ch. 63 Compressed Gases and Cryogenic Fluids, and other applicable regulations.

Next Level: Provide architectural and engineering services to determine storage requirements in cooperation with the users. Provide a fire-rated and ventilated storage room, separated from the Metals Lab and other student spaces.

Provide Ventilation for Welding

Metal Lab lacks welding fume capture
Metal fumes harmful

RELATED SCOPES OF WORK

H-C100-M-4078

H-C100-M-4079				
Priority	Cost			
	\$\$			
Coordination by Discipline				
<input checked="" type="checkbox"/>	<input checked="" type="checkbox"/>		<input checked="" type="checkbox"/>	<input checked="" type="checkbox"/>
A	M	E	P	FP
<input type="checkbox"/>	<input type="checkbox"/>	<input type="checkbox"/>	<input type="checkbox"/>	<input checked="" type="checkbox"/>
S	LS	SC	BE	C

EXISTING CONDITIONS

The Metal Lab has metals welding equipment that can produce hazardous fumes into the room and the air students breathe. Unlike the Wood Lab, the equipment does not have a welding exhaust system to capture the fumes and filter the air.



RECOMMENDATIONS

Provide a system of welding exhaust collection, separate from the wood lab dust collection, with outdoor separation and storage, fire prevention devices, and accessories, to comply with requirements of OSHA's CFR, NFPA 1, and the International Mechanical Code (IMC) 2015, Section 511 Dust, Stock and Refuse Conveying Systems, as well as providing general ventilation in accordance with IMC Chapter 4 Ventilation, Table 403.3.1.1 for education wood and metal shops.

SCOPE OF WORK

Provide outdoor concrete support pad. Provide metal exhaust collector on support pad. Provide ductwork with connections to equipment, and accessories. Provide building penetrations. Provide electrical power and control wiring.

Provide Plotter Exhaust in Tech Cad Room

Large-format plotter
Requires heat & fume exhaust

RELATED SCOPES OF WORK

Not Applicable

H-C105-M-4080	
Priority	Cost
	\$
Coordination by Discipline	
<input checked="" type="checkbox"/>	<input checked="" type="checkbox"/>
<input checked="" type="checkbox"/>	<input checked="" type="checkbox"/>
<input checked="" type="checkbox"/>	<input type="checkbox"/>
<input type="checkbox"/>	<input type="checkbox"/>
<input type="checkbox"/>	<input type="checkbox"/>
<input type="checkbox"/>	<input type="checkbox"/>
<input type="checkbox"/>	<input type="checkbox"/>
S	C



EXISTING CONDITIONS

Plotter has no ducted exhaust to it, and partial exhaust via a ceiling grille.

RECOMMENDATIONS

Provide exhaust to the rear of the plotter, to comply with International Mechanical Code (IMC) 2015, Chapter 4 Ventilation, Table 403.3.1.1 for copy and printing rooms.

SCOPE OF WORK

Prepare plotter to receive ducted exhaust ventilation. Verify plotter manufacturer's recommendations. Provide ductwork and exhaust fan, or duct to an existing exhaust system with the additional airflow capacity required. Provide building penetrations. Provide electrical power and control wiring.

Provide Copier-Printer Exhaust in Teacher Rm

Lacks proper ventilation per Code
May require additional exhaust fan

RELATED SCOPES OF WORK

H-D-A-4027

H-B215-M-4081	
Priority	Cost
	\$
Coordination by Discipline	
<input checked="" type="checkbox"/>	<input checked="" type="checkbox"/>
<input checked="" type="checkbox"/>	<input checked="" type="checkbox"/>
<input checked="" type="checkbox"/>	<input type="checkbox"/>
<input type="checkbox"/>	<input type="checkbox"/>
<input type="checkbox"/>	<input type="checkbox"/>
<input type="checkbox"/>	<input type="checkbox"/>
<input type="checkbox"/>	<input type="checkbox"/>
S	C
LS	BE
SC	C

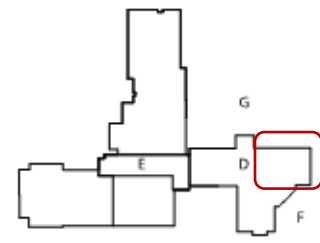

EXISTING CONDITIONS

Copiers-printer does not have local exhaust to remove fumes and odors, as required by current Codes.

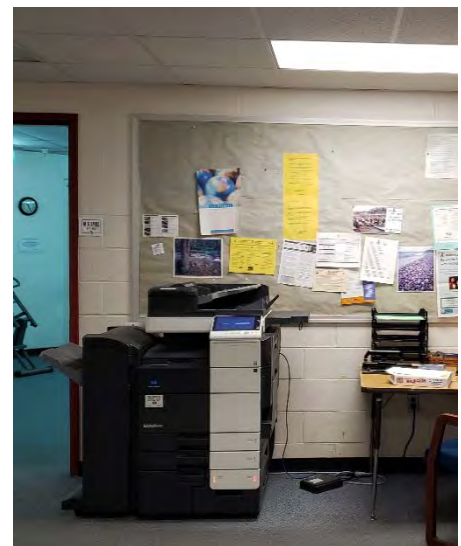

RECOMMENDATIONS

Provide local exhaust with a grille above the copier-printer, to comply with International Mechanical Code (IMC) 2015, Chapter 4 Ventilation, Table 403.3.1.1 for copy and printing rooms. Duct to existing exhaust system if suitable and having available capacity. Provide additional exhaust fan if necessary.

SCOPE OF WORK

Provide ceiling or wall exhaust grille or register. Provide exhaust ductwork to exhaust fan. If it is necessary to add an exhaust fan, provide outdoor termination such as wall louver or roof hood, building penetration, and electrical power. Provide controls to operate the fan continuously during occupied hours, including during nearby zone overrides.

Provide HVAC for OT/PT “Green Room”

Room lacks ventilation and AC
Room has exercise equipment

RELATED SCOPES OF WORK

H-D-A-4027

H-B217-M-4082					
Priority	Cost				
	\$\$				
Coordination by Discipline					
<input checked="" type="checkbox"/>	<input checked="" type="checkbox"/>		<input checked="" type="checkbox"/>	<input type="checkbox"/>	<input type="checkbox"/>
A	M		E	P	FP
<input type="checkbox"/>	<input type="checkbox"/>	<input type="checkbox"/>	<input type="checkbox"/>	<input type="checkbox"/>	
S	LS	SC	BE	C	

EXISTING CONDITIONS

The Green Room which has also been known as Occupational Therapy and Physical Therapy, lacks ventilation. It houses several pieces of exercise equipment. Existing HVAC consists of an exhaust grille, a hydronic heating convactor, and a portable floor fan.

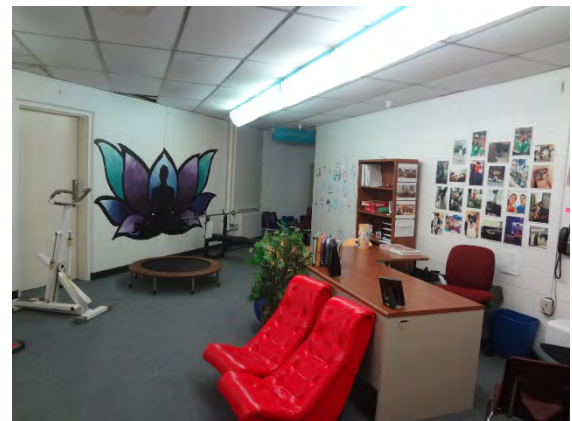

RECOMMENDATIONS

Provide proper ventilation for the occupancy, distributed for effectiveness and comfort. Consider air conditioning.

SCOPE OF WORK

Provide ventilation supply air diffusers or grilles, supply ductwork to a nearby air handling system, and a hydronic duct reheat coil to control room temperature. Provide return or exhaust ductwork to relieve the ventilation air. Provide a ductless split air conditioner or heat pump, with interconnecting piping and wiring. Provide electrical power supply and room controls.

Cape Elizabeth Schools Needs Assessment

Rebalance and Repair AHU Above Stage

AHU-11 above Green Room is rattling
Seems to need repair

RELATED SCOPES OF WORK

Not Applicable

H-C132-M-4083				
Priority	Cost			
	\$			
Coordination by Discipline				
<input checked="" type="checkbox"/>	<input checked="" type="checkbox"/>	<input checked="" type="checkbox"/>	<input type="checkbox"/>	<input checked="" type="checkbox"/>
A	M	E	P	FP
<input checked="" type="checkbox"/>	<input type="checkbox"/>	<input type="checkbox"/>	<input type="checkbox"/>	<input type="checkbox"/>
S	LS	SC	BE	C

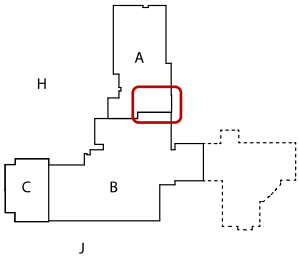

EXISTING CONDITIONS

AHU-11 above Stage Prep can be heard rattling loudly; seems to need repairs.

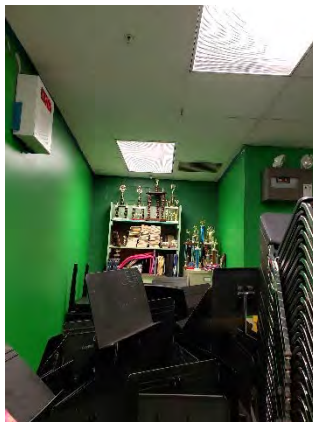

RECOMMENDATIONS

Repair AHU-11, and rebalance airflows.

NEXT LEVEL

Replace AHU-11 under separate work item(s).

SCOPE OF WORK

Base Level: Verify the cause of the rattling noise. Repair or replace AHU components as required to eliminate the noise, as well as to bring the unit into good working condition. Provide the services of a testing and balancing company to rebalance indoor and fresh air airflows at the unit and at terminal devices.

Next level: Replace AHU-11 under separate work item(s), such as to provide better air distribution for indoor air quality, or to provide additional cooling capacity. Rebalance airflows and water flows. Provide electrical power supply. Provide variable frequency drives (VFDs) for speed control as applicable.

Clean Existing Ductwork to Remain

Clean ductwork inside, repair linings
Heavy dust seen near air handlers

RELATED SCOPES OF WORK

Not Applicable

H-ALL-M-4084	
Priority	Cost
	\$
Coordination by Discipline	
<input checked="" type="checkbox"/>	<input checked="" type="checkbox"/> <input type="checkbox"/> <input type="checkbox"/> <input type="checkbox"/>
A	M E P FP
<input type="checkbox"/>	<input type="checkbox"/> <input type="checkbox"/> <input type="checkbox"/> <input type="checkbox"/>
S	LS SC BE C

EXISTING CONDITIONS

Heavy dust buildup is seen inside ductwork near air handling units. Filters in these units receive a lot of dust and pollen, and because of imperfect fit and some overloading they allow some air to bypass unfiltered. Dust buildup is also seen at terminal inlet and outlet grilles and diffusers. Schools bring in large amounts of outdoor air which bears outdoor contaminants such as dust, pollen, and humidity, and have large dense populations of people who generate dust and other contaminants. Ducts can store these contaminants and distribute them to the occupants, and in some conditions such as high humidity the dirty duct surfaces can promote unhealthy biological growth. Periodic duct cleaning has become standard practice in many schools and other buildings, to promote healthy indoor air quality (IAQ).

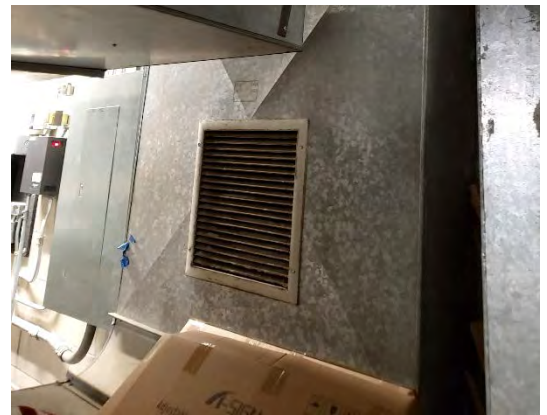

RECOMMENDATIONS

Have the interiors of ductwork cleaned by an experienced and reputable service specializing in duct cleaning. Prioritize supplies, returns, transfers, and exhausts in order of their potential for exposing occupants to contaminants.

NEXT LEVEL

Replace existing duct acoustic and insulating linings in ducts and air handling equipment, with new materials of same or equal performance to eliminate loose fibers and crumbling foams as sources of airborne particles and residual contaminants.

SCOPE OF WORK

Provide the services of an independent duct cleaning company. Perform an initial inspection to verify the existing state of HVAC system cleanliness, and to locate any suspected hazardous materials that may require abatement prior to the cleaning process. Provide access openings in ducts and building assemblies as required, and upstream of any coils including heating coils integral to variable air volume (VAV) boxes, and provide removable access doors and access panels in the openings for future access. Clean the interiors of ducts, duct coils, and other surfaces using mechanical, vacuum, and other methods, as recommended by The National Air Duct Cleaners Association (NADCA) in their latest ACR standard for assessment, cleaning, and restoration of HVAC systems. Perform inspections and testing to verify cleaning as recommended. Protect occupants, and protect smoke detectors and other fire detection and control devices in ductwork systems, during the cleaning processes. Identify any damaged materials such as acoustic linings, and replace them with new.

Replace Damaged Diffusers and Grilles

Diffusers and grilles have damage
Most remain functional

RELATED SCOPES OF WORK

Not Applicable

H-ALL-M-4085	
Priority	Cost
	\$
Coordination by Discipline	
<input checked="" type="checkbox"/>	<input checked="" type="checkbox"/> <input type="checkbox"/> <input type="checkbox"/> <input type="checkbox"/>
A	M E P FP
<input type="checkbox"/>	<input type="checkbox"/> <input type="checkbox"/> <input type="checkbox"/> <input type="checkbox"/> <input type="checkbox"/>
S	LS SC BE C

EXISTING CONDITIONS

Some air diffusers, grilles, and registers have damage. Most remain functional to deliver the air.



RECOMMENDATIONS

Replace damaged units for better appearance and to ensure proper performance. Where subject to repeated damage they may be upgraded to sturdier types.

SCOPE OF WORK

Determine required airflows and performance. Remove devices, and replace with new meeting the requirements. Fasten and seal to ductwork. Adjust air pattern vanes and other accessories. Rebalance airflows. It is additionally recommended to measure airflows of existing devices before doing any work, and to coordinate existing airflows with design expectations.

Fan Blades Exposed to Outdoors

Mechanical room fan blades reachable thru backdraft damper

RELATED SCOPES OF WORK

H-B216-M-4073

H-B216-M-4086				
Priority	Cost			
	\$			
Coordination by Discipline				
<input checked="" type="checkbox"/>	<input checked="" type="checkbox"/>	<input checked="" type="checkbox"/>	<input type="checkbox"/>	<input type="checkbox"/>
A	M	E	P	FP
<input type="checkbox"/>	<input type="checkbox"/>	<input type="checkbox"/>	<input type="checkbox"/>	<input type="checkbox"/>
S	LS	SC	BE	C

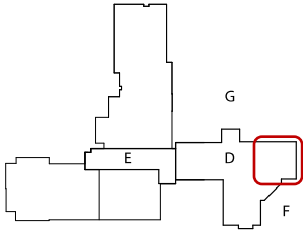

EXISTING CONDITIONS

2nd-floor mechanical air handling and storage room’s propeller-type cooling fan discharges low on outside wall. Instead of a louver with protective screen, the outlet is a gravity backdraft damper. Students can reach in through the backdraft damper and touch the spinning fan blades. Outlet is poorly installed in the brick veneer wall, with much daylight seen indoors around the unsealed wall penetration. Outlet is also only about 6 feet from the main air handling system intake louver; this concern is less than the safety issue because the mechanical room exhaust is environmental air and may not be heavily contaminated. The main intake and exhaust louvers are about 14 feet apart which would allow the fan to be farther from the intake. Louvers in this area are damaged by student impact such as sports activities, as well as possible vandalism.

RECOMMENDATIONS

Renovate the fan assembly to provide finger protection, to prevent human entry, and to make weather-tight.

NEXT LEVEL

Relocate the fan to provide 10 feet separation from the main mechanical room air handling system intake louver.



SCOPE OF WORK

1. Base Level: Remove the fan and damper assembly from the wall. Provide an impact-resistant louver with interior bird screen for finger protection and properly seal to wall penetration. Provide burglar bars to prevent human entry per State of Maine standards, duct plenum with access door for cleaning, and backdraft damper suitable for in-duct mounting. Reinstall the fan on the inner open end of the duct plenum. Insulate duct plenum. Reconnect the fan power and controls.
2. Next Level: In addition to the basic level modifications, relocate the fan to at least 10 feet from the intake louver. Some separation from the main exhaust louver will be necessary for structural reasons; modify louver and damper width and height as necessary to maintain the 10-foot separation. Provide a new architectural wall opening, with supportive steel lintel as necessary, and infill the existing opening to match surrounding wall. Extend power and control wiring to the new fan location.

Louver Security and Damage

To meet the Maine DoE requirements for low louvers security, and for damage

RELATED SCOPES OF WORK

Not Applicable

H-ALL-M-4087				
Priority	Cost			
	\$\$			
Coordination by Discipline				
<input checked="" type="checkbox"/>	<input checked="" type="checkbox"/>	<input type="checkbox"/>	<input type="checkbox"/>	<input type="checkbox"/>
A	M	E	P	FP
<input type="checkbox"/>	<input type="checkbox"/>	<input type="checkbox"/>	<input checked="" type="checkbox"/>	<input type="checkbox"/>
S	LS	SC	BE	C

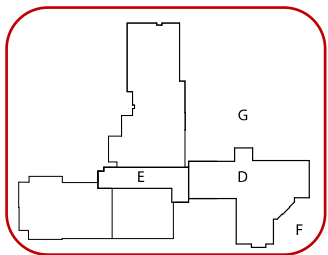

EXISTING CONDITIONS

Large louvers within 8 feet of grade lack security protection required by Maine Department of Education Public School security standards. One has added exterior steel protective screen which is rusting and staining the wall. Low louvers in general are damaged by student impact such as sports activities, as well as possible vandalism. Some louvers are simple type that lack the drainable-blade and other features to limit water and snow intrusion.

RECOMMENDATIONS

Renovate the louver assemblies to provide inner burglar bars for security.

NEXT LEVEL

Replace louvers to eliminate existing damage, and potentially reduce future damage.

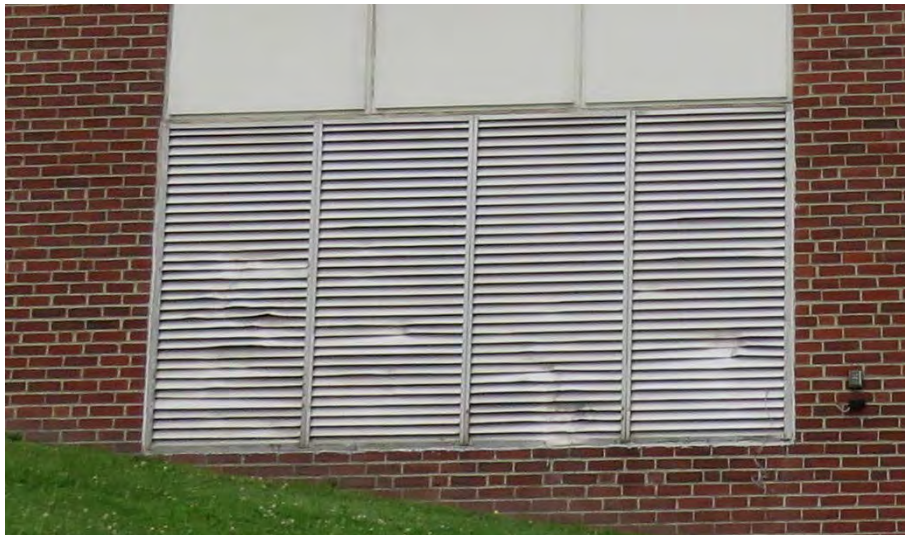

SCOPE OF WORK

- A. Base Level: Disassemble ductwork from the louvers as required. Install welded horizontal and vertical steel bars within the ductwork, with strength and spacing to prohibit intruder entry. Reinforce ducts as necessary. Reinsulate ducts and louver plenums where disturbed.
- B. Next Level: Replace louvers with more impact-resistant type, but selected and sized properly for airflow, pressure drop, and velocity for water and snow intrusion. Disassemble ductwork as necessary. Reinsulate ducts and louver plenums where disturbed. Seal louvers to walls weather-tight with color-matching sealant. Louvers may be furnished with a colored finish if desired, such as a high-quality 70% Kynar type with 10-year warranty.

Unit Ventilator Louver Damage

Unit ventilator intake louvers are damaged

RELATED SCOPES OF WORK

Not Applicable

H-ALL-M-4088				
Priority	Cost			
	\$			
Coordination by Discipline				
<input checked="" type="checkbox"/>	<input checked="" type="checkbox"/>	<input type="checkbox"/>	<input type="checkbox"/>	<input type="checkbox"/>
A	M	E	P	FP
<input type="checkbox"/>	<input type="checkbox"/>	<input type="checkbox"/>	<input checked="" type="checkbox"/>	<input type="checkbox"/>
S	LS	SC	BE	C

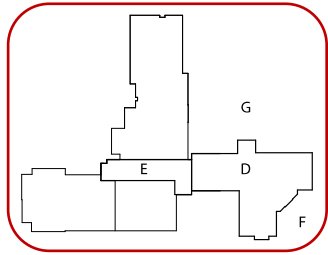

EXISTING CONDITIONS

Unit ventilator intake air louvers in general are damaged. This may be due simply to advanced age, but in many cases is likely due to student impact such as sports activities, as well as possible vandalism. These louvers are generally light-duty and lack the drainable-blade and other features to limit water and snow intrusion. Some of the louvers are recent replacements, but were not fastened and sealed into the wall openings properly. Also, unit ventilators are notorious for having poor sealing between the louvers and the units, allowing significant outside air infiltration and energy loss. Unit ventilator louvers that are low to the ground are not likely security risks because of their vertical dimension of about 16 inches, and blockage by the unit ventilator.

RECOMMENDATIONS

Replace louvers to eliminate existing damage, and potentially reduce future damage. Seal and insulate within unit ventilator cabinets to reduce energy usage.

NEXT LEVEL

Replace unit ventilators with a more centralized ventilation and heating system, in a related scope of work.



SCOPE OF WORK

- A. Basic Level: Disassemble ductwork and unit ventilators from the louvers as required. Replace louvers with more impact-resistant type, but selected and sized properly for airflow, pressure drop, and velocity for water and snow intrusion. Seal louvers to walls weather-tight with color-matching sealant. Louvers may be furnished with a colored finish if desired, such as a high-quality 70% Kynar type with 10-year warranty. Insulate, seal, and provide baffles within unit ventilator cabinets to minimize outdoor air leakage.
- B. Next Level: Replace unit ventilators with a more centralized ventilation and heating system, in a related scope of work. Remove the unit ventilators and related utilities, insulate and patch the inner face of the exterior wall, and refinish other surfaces such as floors and cabinetry. Remove the louver openings and infill with brick to match the surrounding walls.

Intake and Exhaust Louver Separation

Mechanical room fan blades reachable thru backdraft damper

RELATED SCOPES OF WORK

H-B216-M-4073

H-B216-M-4089				
Priority	Cost			
	\$			
Coordination by Discipline				
<input checked="" type="checkbox"/>	<input checked="" type="checkbox"/>	<input checked="" type="checkbox"/>	<input type="checkbox"/>	<input type="checkbox"/>
A	M	E	P	FP
<input type="checkbox"/>	<input type="checkbox"/>	<input type="checkbox"/>	<input checked="" type="checkbox"/>	<input type="checkbox"/>
S	LS	SC	BE	C

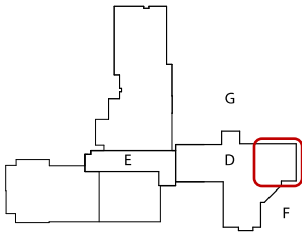

EXISTING CONDITIONS

2nd-floor mechanical air handling room’s combined relief/exhaust louver receives both Class 1 (occupied room) relief/exhaust air from the return fan, and Class 2 (potential odors) air from toilet and similar rooms via the main exhaust fan. Such a louver should be 10 feet from fresh air intakes. This louver is about 6 and 8 feet from intake louvers to unit ventilators on the 3rd floor above. Louvers in this area are damaged by student impact such as sports activities, as well as possible vandalism.



RECOMMENDATIONS

Relocate the unit ventilator intake louvers to 10 feet from this louver to meet code required separation distances.

NEXT LEVEL

Replace unit ventilators with a central ventilation and heating system, with wall or roof intake openings 10 feet or more from this louver.

SCOPE OF WORK

1. Base Level: Remove the unit ventilator intake louvers from the wall, and infill the existing opening to match surrounding wall. Provide new architectural wall openings, with supportive steel lintels as necessary, at least 10 feet from the relief/exhaust louver. Provide impact-resistant louvers, properly sealed to wall penetration, with ducts to the unit ventilators. Remove the unit ventilators and relocate at the new intake louvers. Extend hot water piping to the unit ventilators. Rebalance air and water flows. Extend power and control wiring to unit ventilators.
2. Next Level: Remove unit ventilators, louvers and associated piping and wiring. Provide a central ventilation and heating system, such as an energy -recover ventilator with supply air heating coils, with wall or roof intake openings 10 feet or more from the relief/exhaust louver and any other contaminant sources such as plumbing roof vents. Provide ductwork, heating piping, and controls. Balance air and water flows. Provide support for the unit, wall and roof penetrations, and power supply.

Teacher Lounge Remove Abandoned Exhaust

Grilles from room's former use
should be removed

RELATED SCOPES OF WORK

H-D-A-4027

H-B212-M-4090				
Priority	Cost			
	\$			
Coordination by Discipline				
<input checked="" type="checkbox"/>	<input checked="" type="checkbox"/>	<input type="checkbox"/>	<input type="checkbox"/>	<input type="checkbox"/>
A	M	E	P	FP
<input type="checkbox"/>	<input type="checkbox"/>	<input type="checkbox"/>	<input type="checkbox"/>	<input type="checkbox"/>
S	LS	SC	BE	C

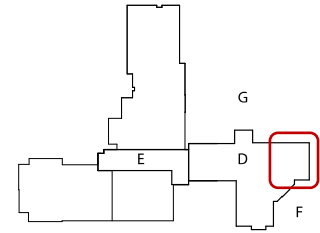

EXISTING CONDITIONS

Teacher Lounge B212 has 3 unnecessary low exhaust or return grilles including below the sink and behind the refrigerator. These were made redundant when ceiling return grille was installed under the 2004 design, but are still connected to ducts and may still be pulling air unnecessarily. These are unneeded sound paths to the mechanical room for voice transmission and mechanical equipment noise. They may be restricting occupants' use of the wall space. The ductwork fills space in Mech. Room B216 that could be used for storage.

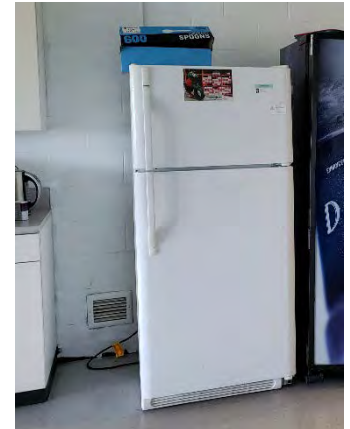

RECOMMENDATIONS

Eliminate these grilles and associated ductwork, and fill in the wall openings to match surroundings.

SCOPE OF WORK

Verify and document ceiling supply, ceiling return, and low exhaust airflows for this room before work, and rebalance remaining supply and return after work is complete. Remove grilles. Remove ductwork completely, back to the main duct, and cap and seal the branch connection. Infill the CMU partition penetrations to match adjacent CMU, and paint to match surroundings.

Mech Room B216 - Replace Valves & Fittings

Many leaky & corroded valves, fittings
May be part of equipment replacement

RELATED SCOPES OF WORK

H-B216-M-4073

H-B216-M-4091				
Priority	Cost			
	\$			
Coordination by Discipline				
<input type="checkbox"/>	<input checked="" type="checkbox"/>	<input type="checkbox"/>	<input checked="" type="checkbox"/>	<input type="checkbox"/>
A	M	E	P	FP
<input type="checkbox"/>	<input type="checkbox"/>	<input type="checkbox"/>	<input type="checkbox"/>	<input type="checkbox"/>
S	LS	SC	BE	C

EXISTING CONDITIONS

Heating piping has many leaky and corroded valves and unions. Water flow-setting valves are old and obsolete "Illinois" brand valves that may have an adjustment screw but have no way to measure the flow. Many of these items are immediately adjacent to equipment such as air handling unit coils and the unit heater. The piping in general is old, and of unknown internal condition; external rust on some piping fittings may be from past conditions rather than ongoing leakage. Water stains on the floor were only in a few areas, whereas rusty fittings were in many areas.

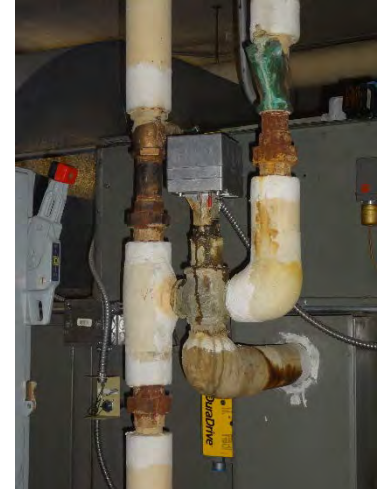
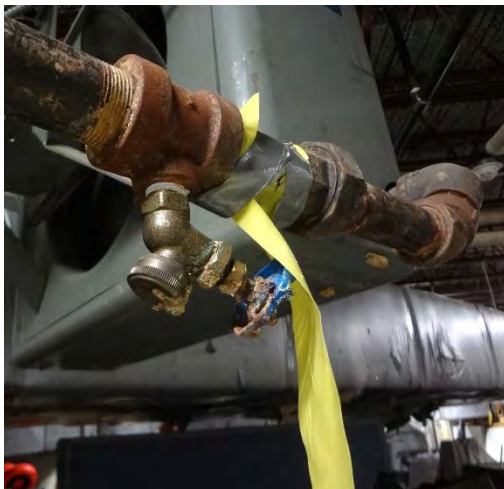

RECOMMENDATIONS

Replace heating valves and unions, and replace other leaking fittings, throughout this room, to prevent water damage to the building and to avoid service interruptions due to breakdowns.

NEXT LEVEL

Replace all the piping in the room following existing pipe hanger routing.

SCOPE OF WORK

Base Level: Coordinate with other work items, such as current or future replacement of equipment in this room. Remove pipe insulation as required for accessing piping. Remove all balancing valves and drain valves, any leaking control valves, and any unions showing any signs of leakage. Also remove unions which upon disconnecting to remove other items show signs of internal leakage or that may be difficult to re-seal. Replace balancing valves, using circuit-setter type balancing valves (combination valves providing flow measurement, flow setting, and tight shutoff). Replace drain valves, using ball valves (more reliable and less leak-prone than the compression-type "boiler drain" valves). Replace control valves, using electrically-actuated true globe or ball type control valves. Replace unions. Pressure test the piping until it proves leak-free. Remove hanger bands which were sized to fit onto the piping, and provide hanger bands sized to fit outside the piping insulation. Provide piping insulation, with long galvanized steel shields glued to the insulation at hangers, and rigid inserts at hangers on larger piping to prevent compression of the insulation.

Mech Room B216 - Remove Pneumatic Controls

Pneumatic controls appear abandoned
Some items are without any control

RELATED SCOPES OF WORK

H-B216-M-4073

H-B216-M-4092	
Priority	Cost
	\$
Coordination by Discipline	
<input type="checkbox"/>	<input checked="" type="checkbox"/>
<input checked="" type="checkbox"/>	<input checked="" type="checkbox"/>
<input checked="" type="checkbox"/>	<input checked="" type="checkbox"/>
<input type="checkbox"/>	<input type="checkbox"/>
A	M
E	P
FP	
<input type="checkbox"/>	<input type="checkbox"/>
<input type="checkbox"/>	<input type="checkbox"/>
S	LS
SC	BE
C	

EXISTING CONDITIONS

Some of the duct coils have pneumatic control valves which may no longer be operating; one of the pneumatic actuators has its air tubing cut off. Another pneumatic tube runs into the ceiling; it is not obvious where this runs to. There is an abandoned Honeywell pneumatic control panel near the doorway labeled Type W726A Master Oscillator, with a pneumatic pressure regulator and other devices. There is an abandoned pneumatic air dryer and piping station at the water entrance.

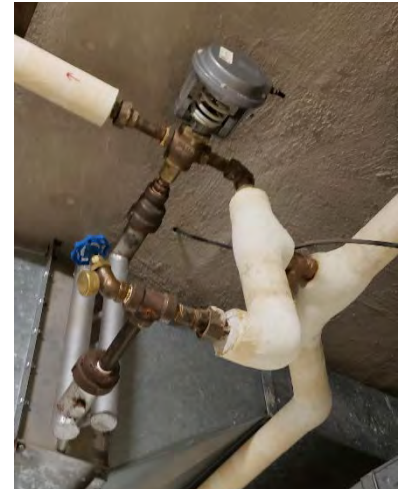

RECOMMENDATIONS

At duct coils, remove pneumatic control valves. Provide electric-electronic control valves and DDC direct digital controllers. Remove abandoned Honeywell pneumatic control panel near doorway, abandoned pneumatic air dryer and air piping station at water entrance, and pneumatic tubing throughout the room.

SCOPE OF WORK

Coordinate with other work items, such as current or future replacement of equipment in this room. At duct coils, remove pneumatic control valves; provide electric-electronic control valves and DDC direct digital controllers. Provide any additional replacements of pneumatic with DDC, both in this room and in any nearby spaces that were served by tubing from this room, as required to allow complete removal of pneumatics, and to restore full control that has been lost due to previous abandonment. Remove abandoned Honeywell pneumatic control panel near doorway, abandoned pneumatic air dryer and air piping station at water entrance, and pneumatic tubing throughout the room.

Nurses Toilet B323 - Move Fintube for ADA

Fintube is within ADA clearance
Maine DoE requires fintube be higher

RELATED SCOPES OF WORK

H-D-A-4028

H-B323-M-4093	
Priority	Cost
	\$
Coordination by Discipline	
<input checked="" type="checkbox"/>	<input checked="" type="checkbox"/> <input type="checkbox"/> <input type="checkbox"/> <input type="checkbox"/>
A	M E P FP
<input type="checkbox"/>	<input type="checkbox"/> <input type="checkbox"/> <input type="checkbox"/> <input type="checkbox"/>
S	LS SC BE C

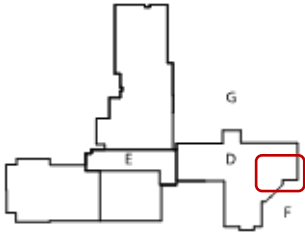

EXISTING CONDITIONS

The hydronic fintube radiation heating is mounted on the exterior CMU wall, within the clear space required for ADA wheelchair access to the water closet. This location is also contrary to the requirement to avoid fintube radiation at floor level in toilet rooms, found in the Maine Department of Education Public School Standards and Guidelines for New School Construction & Major Renovation Projects. The hot water piping is fed from the 2nd floor ceiling cavity below, exposed under fintube. The room's ceiling exhaust fan is above the fintube. The interior partitions and furred space behind the water closet are stud type.

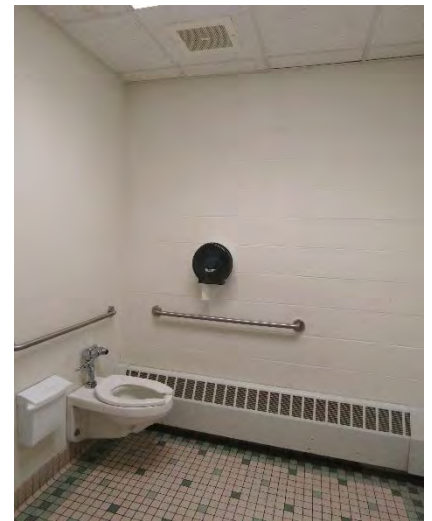

RECOMMENDATIONS

Relocate fintube to another side of the room, or to high on the wall.

SCOPE OF WORK

Verify the new location for the fintube to meet ADA accessibility and other requirements. Mounting low could comply with ADA, while mounting high could comply with both ADA and the Maine DoE standards. If mounting high, inverting the enclosure is often done to improve appearance. The partition opposite the water closet and lavatory may have enough space for low mounting, but the limited space at the hinge side of the door must be verified to fit the full width of the fintube. Mounting high on the outside wall above the current location would require running the piping up in a partition or the furred-out space behind the water closet, and moving the exhaust fan away from the fintube would be advised. Mounting high on other walls would similarly require running the piping up. Remove the fintube and any valves and accessories within the enclosure; clean and store for reinstallation. Disconnect hydronic piping above the 2nd floor ceiling, and extend it to rise at the new location. If the control valve is relocated, extend control wiring to the new location. Provide floor and wall penetrations, with sleeves and firestop as required. Patch and paint floor, walls, and partitions.

Cape Elizabeth Schools Needs Assessment

Vestibule B319 - Replace Cabinet Unit Heater

Heater is very old and in poor condition
Flat top allows setting items on grille

RELATED SCOPES OF WORK

Not Applicable

H-B319-M-4094				
Priority	Cost			
	\$			
Coordination by Discipline				
<input checked="" type="checkbox"/>	<input checked="" type="checkbox"/>	<input checked="" type="checkbox"/>	<input type="checkbox"/>	<input type="checkbox"/>
A	M	E	P	FP
<input type="checkbox"/>	<input type="checkbox"/>	<input type="checkbox"/>	<input type="checkbox"/>	<input type="checkbox"/>
S	LS	SC	BE	C

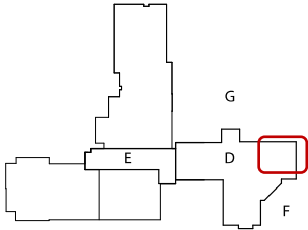

EXISTING CONDITIONS

Original AAF Herman Nelson cabinet unit heater is in poor condition; old, dirty, damaged.



RECOMMENDATIONS

Replace with new cabinet unit heater, for better appearance, performance, and reliability.

SCOPE OF WORK

Remove cabinet unit heater. Remove hot water piping to below floor as required, and remove piping to enable adding a control valve. Remove power and control wiring to below the floor. Prepare and patch wall and floor surfaces. Provide new cabinet unit heater and supports, with slope top and front discharge to prevent blockage, tamper-resistant access latches and fasteners, EC fan motor, and variable-speed fan controller with disconnect switch. Install new cabinet unit heater and supports. Provide heating piping to the unit, with sleeves at floor penetrations, and a control valve in the return line within the cabinet or in the 2nd floor ceiling cavity as appropriate. Provide a strap-on aquastat on the return pipe to verify hot water flow. Insulate piping including valves, fittings, and the aquastat bulb. Provide power and control wiring. Provide wall temperature sensor and DDC controls; control to open the control valve and to start the fan after the aquastat proves hot water flow; maintain vestibule temperature at occupied/unoccupied setpoints meeting the State Energy Code. Provide firestop and watertight seals at floor penetrations.

Replace Wall Relief Grille with Larger

Grille is too small, restricts the unit ventilator's economizer cooling

RELATED SCOPES OF WORK

H-ALL-M-4058

H-309-M-4096					
Priority	Cost				
	\$				
Coordination by Discipline					
<input checked="" type="checkbox"/>	<input checked="" type="checkbox"/>		<input type="checkbox"/>	<input type="checkbox"/>	<input type="checkbox"/>
A	M		E	P	FP
<input type="checkbox"/>	<input type="checkbox"/>	<input type="checkbox"/>	<input type="checkbox"/>	<input type="checkbox"/>	
S	LS	SC	BE	C	

EXISTING CONDITIONS

Wall relief grille is undersized at 8"x6" rather than 12"x8" indicated in 2004 design, and smaller than grilles in the adjacent rooms. This can restrict the ability of the room's unit ventilator (UV) to bring in the required minimum outdoor ventilation air, and prevent the UV from increasing the outdoor to provide "economizer" free cooling.



RECOMMENDATIONS

Replace with proper size to provide relief of incoming ventilation air including full economizer airflow.

SCOPE OF WORK

Provide design services to verify the sizes of grille and ductwork to allow the unit ventilator to provide full economizer cooling without over-pressurizing the room. Remove grille and connected ductwork to a point of connection to a properly sized duct main. Provide a larger wall opening. Provide properly sized grille, duct, and relief damper. Provide testing and balancing to verify intake and relief during unit ventilator operation, both in minimum occupied ventilation mode and in full economizer cooling operation.

Relocate CUH Wall Temperature Sensor

Temperature sensor located above CUH
May provide false readings

RELATED SCOPES OF WORK

Not Applicable

H-A111-M-4097				
Priority	Cost			
	\$			
Coordination by Discipline				
<input checked="" type="checkbox"/>	<input checked="" type="checkbox"/>		<input checked="" type="checkbox"/>	<input type="checkbox"/>
A	M	E	P	FP
<input type="checkbox"/>	<input type="checkbox"/>	<input type="checkbox"/>	<input type="checkbox"/>	<input type="checkbox"/>
S	LS	SC	BE	C

EXISTING CONDITIONS

Wall temperature sensor is directly above the cabinet unit heater.

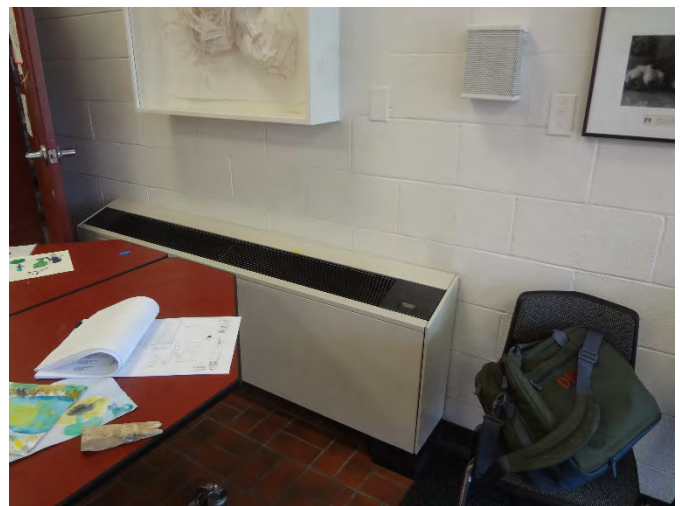

RECOMMENDATIONS

Move sensor to a suitable location where it is not subject to false readings of room temperature due to the hot air from the cabinet unit heater, and provide wiring.

SCOPE OF WORK

Remove sensor and guard. Extend control wiring to suitable wall sensor location remote from the heater. Run wiring vertical riser concealed within the CMU partition if possible, but in surface "Wiremold" type raceway if necessary. Make any wiring splices accessible for future repair. Reinstall sensor and guard at new location. Patch existing location including wiring and guard mounting holes and paint; a blank electrical plate in standard or large size may be used to cover the wall box if there is one.

Kitchen Hood Switch and Appliance Coverage

Light switch high on hood, hard to reach
 Hood coverage of 2-pot burner is poor
 Interlock of fan and cooking not seen

RELATED SCOPES OF WORK

Not Applicable

H-A126-M-4098				
Priority	Cost			
	\$\$			
Coordination by Discipline				
<input checked="" type="checkbox"/>	<input checked="" type="checkbox"/>	<input checked="" type="checkbox"/>	<input type="checkbox"/>	<input type="checkbox"/>
A	M	E	P	FP
<input type="checkbox"/>	<input type="checkbox"/>	<input type="checkbox"/>	<input type="checkbox"/>	<input type="checkbox"/>
S	LS	SC	BE	C

EXISTING CONDITIONS

The switch for the kitchen hood's lights is mounted on the front of the hood over 6 feet above the floor. The fan switch is on the wall in the form of start/stop buttons on the motor starter or controller. Control of makeup air, It appears that the hood fan operation is not interlocked with cooking operation as is required by current Codes. The hood's coverage of the existing 2-pot gas burner is marginal and may not meet Codes.

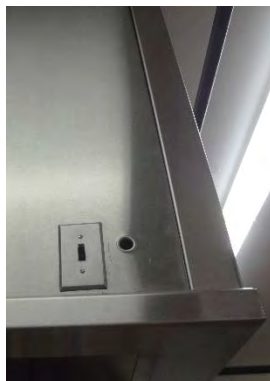

RECOMMENDATIONS

Relocate the hood switch to a wall location within ADA reachable height. Provide controls to interlock the exhaust fan and makeup-air supply fan with the cooking operation; the typical method is to use heat sensors above the cooking appliances to sense when cooking occurs; many appliances do not have internal controls that can be used for this function. Move the 2-pot burner for proper hood coverage.

NEXT LEVEL

Provide variable speed drives or equivalent on the exhaust and supply fan motors. Provide a control system which varies fan speeds based on the temperatures and smoke above the appliances or in the exhaust duct.

SCOPE OF WORK

1. Base Level: Relocate the hood light switch to a wall location within ADA reachable height; provide surface-mounted box and conduit on the CMU partition. Provide a system of controls to interlock the exhaust fan and makeup-air supply fan with the cooking operation. The controls would include: heat sensors above the cooking appliances to sense when cooking occurs; interfacing controller between these sensors and the fan motor starters as required; and interface between the fan controller and the wall switch to allow manual override on, but prevent using the wall switch to manually stop the fan during cooking. Modify the 2-pot burner's location to provide required hood overhang beyond the appliance.
2. Next Level: Provide the Base Level, plus a packaged controller such as MeLink or CaptiveAire to provide variable speed control of the fans proportionate to the cooking temperature and smoke above the appliances or in the exhaust duct. Provide variable speed control devices on each fan, to vary fan speed in response to proportional control signals, such as additional variable frequency drives (VFDs) or replacement electronically-commutated motors (ECMs).

Provide Emergency Plumbing Fixtures

Science lab classrooms lack fixtures.
Where showers exist they lack drains.

RELATED SCOPES OF WORK

H-320-A-4030
H-B216-P-4109

H-ALL-P-4099				
Priority	Cost			
	\$\$			
Coordination by Discipline				
<input checked="" type="checkbox"/>	<input type="checkbox"/>	<input type="checkbox"/>	<input checked="" type="checkbox"/>	<input type="checkbox"/>
A	M	E	P	FP
<input type="checkbox"/>	<input type="checkbox"/>	<input type="checkbox"/>	<input type="checkbox"/>	<input type="checkbox"/>
S	LS	SC	BE	C

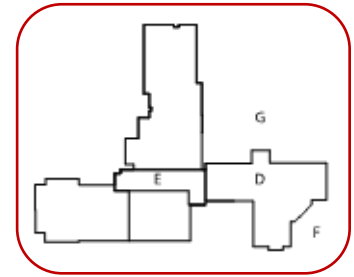

EXISTING CONDITIONS

High school science laboratory classrooms do not contain emergency eyewash or shower fixtures. Some janitor spaces utilize self-contained eyewash stations, which may not fully comply with OSHA standards, and clear access isn't being maintained. The Maine Department of Education document *Public School Standards & Guidelines for New School Construction & Major Renovation Projects* requires emergency eyewash and showers for science laboratory classrooms. Where any emergency showers exist they do not all have floor drains, which may inhibit use and testing due to the potential for water damage, and may not have tepid water. Eyewashes are not ADA accessible and have only cold water rather than tepid.

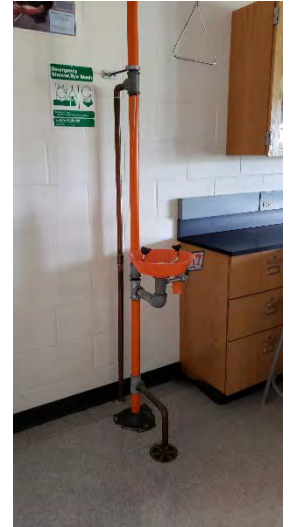
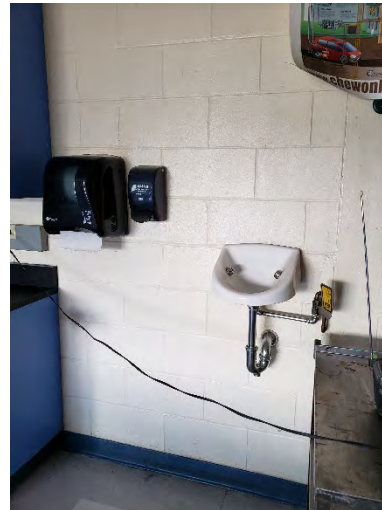

RECOMMENDATIONS

Provide at each high school science classroom a plumbed combination emergency unit with eyewash or eye/face wash and shower, and provide a floor drain and piping. Provide floor drains at any existing showers that do not have drains. Provide at each janitor closet or space utilizing chemicals an emergency eyewash or eye/face wash, which may be plumbed or self-contained ("portable") type. Provide ADA accessibility where applicable, and replace any existing emergency fixtures which do not have adequate accessibility for the location. Provide replacement emergency fixtures to meet ADA accessibility. Provide tepid water supplies to plumbed emergency fixtures, including existing ones which have only cold water; do not downgrade these locations to non-plumbed type.

SCOPE OF WORK

Provide eyewashes or eye/face washes, with showers and floor drains sized for the shower flow rate where applicable. At plumbed (not self-contained/portable) emergency fixtures, provide hard-piped sanitary drain and vent piping for eyewash (or eye/face wash) bowls, and piped tepid water supply with an approved-type tempering valve with thermometer set to between 60°F and 90°F at each fixture. Water supplies shall conform to ANSI/ISEA Z358.1 as required by Maine's plumbing code in the Uniform Plumbing Code (UPC) 2015 Chapter 416.2. At each tempering valve provide domestic hot and cold water piping, and provide recirculated hot water piping to near the tempering valve to shorten the waiting time for tepid water. Provide sanitary and vent piping at floor drains, sized for the shower flow rate of 20 gpm for 15 minutes. Provide proper signage, and designate and permanently mark clear floor and other access areas to be maintained at all times. Provide architectural design and modifications of spaces and access at emergency fixtures, and architectural finishes and trim as required.

Provide Automatic-Sensor Control at Fixtures

Most fixtures have manual controls

RELATED SCOPES OF WORK

H-B246-A-4001

H-ALL-P-4100				
Priority	Cost			
	\$\$\$			
Coordination by Discipline				
<input checked="" type="checkbox"/>	<input type="checkbox"/>	<input checked="" type="checkbox"/>	<input checked="" type="checkbox"/>	<input type="checkbox"/>
A	M	E	P	FP
<input type="checkbox"/>	<input type="checkbox"/>	<input type="checkbox"/>	<input type="checkbox"/>	<input type="checkbox"/>
S	LS	SC	BE	C

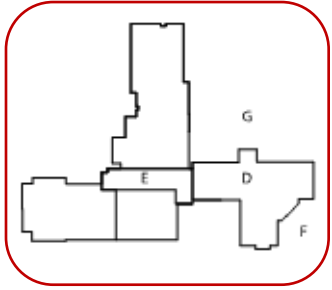

EXISTING CONDITIONS

Existing lavatory fixtures are a mixture of automatic and manual operation. Existing fixtures are non-uniform throughout and vary including multi-faucet automatic lavatory stations to individual vitreous china manual lavatories, and toilets vary including both floor and wall-mounted units with both manual and automatic flushometers. However, most plumbing fixtures have manual controls. Some have accessibility issues due to the control design or placement.

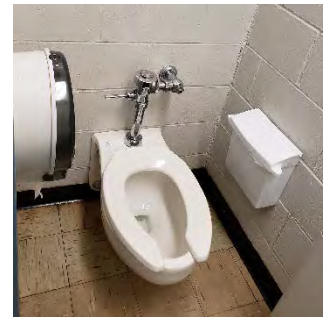

RECOMMENDATIONS

Provide hard-wired automatic flushometers for toilets and urinals, and hard-wired automatic sensors for lavatories to meet the Maine Department of Education Requirements. The hard-wired units provide greater reliability than battery-operated units. Provide fixtures compliant with EPA WaterSense maximum allowable flow rates of 1.28 gpf for toilets, 0.5 gpf for urinals, and 1.5 gpm for lavatories, where feasible. Aerators may be provided at lavatories, and a 15-second automated duration may be utilized. Provide new fixtures where the existing cannot support automatic sensors. In the instance that an automatic sensor is fitted to an existing water closet or urinal, the sensor flow rate must match the fixture flow rate.

SCOPE OF WORK

Maine Department of Education issued the document titled *Public School Standards & Guidelines for New School Construction & Major Renovation Projects* which requires automatic controls at sinks and toilets. Provide hard-wired flushometers for toilets and urinals, and automatic sensors for lavatories. Provide fixtures compliant with EPA WaterSense maximum allowable flow rates of 1.28 gpf for toilets, 0.5 gpf for urinals, and 1.5 gpm for lavatories. Aerators may be provided at lavatories, and a 15-second automated duration may be utilized. Provide electrical wiring for flushometers and lavatory sensors. Provide new fixtures where the existing cannot support automatic sensors. Provide architectural and engineering services to recommend replacements in cooperation with building users, including an analysis of accessibility to comply with ADA. Remove existing controls, and install replacements. Provide electrical power supplies as required.

Replace Sanitary Piping in Ceiling Cavities

3rd Floor Women's Toilet Rm. leakage

RELATED SCOPES OF WORK

H-ALL-E-4048

H-A313-P-4101					
Priority	Cost				
	\$\$				
Coordination by Discipline					
<input checked="" type="checkbox"/>	<input type="checkbox"/>		<input checked="" type="checkbox"/>	<input checked="" type="checkbox"/>	<input type="checkbox"/>
A	M		E	P	FP
<input type="checkbox"/>	<input type="checkbox"/>		<input type="checkbox"/>	<input type="checkbox"/>	<input type="checkbox"/>
S	LS	SC	BE	C	

EXISTING CONDITIONS

Some sanitary or other type of piping above the Women's Room ceiling is reportedly leaking.

RECOMMENDATIONS

Repair piping to eliminate leaks.



SCOPE OF WORK

Remove leaking portions of piping, fittings, and valves as required. Repair or replace piping and its insulation as required to eliminate leaks. Repair or replace any damaged ceiling tiles and other finishes as required.

Cape Elizabeth Schools Needs Assessment

Replace Domestic Water to Science Classrooms

Water to 1st thru 3rd floor Science rooms shut off due to leakage

RELATED SCOPES OF WORK

H-320-A-4030

H-ALL-P-4102				
Priority	Cost			
	\$			
Coordination by Discipline				
<input checked="" type="checkbox"/> <input type="checkbox"/> <input type="checkbox"/> <input checked="" type="checkbox"/> <input type="checkbox"/>				
A	M	E	P	FP
<input type="checkbox"/>	<input type="checkbox"/>	<input type="checkbox"/>	<input type="checkbox"/>	<input type="checkbox"/>
S	LS	SC	BE	C

EXISTING CONDITIONS

During site investigation, there was no water flowing to the 1st through 3rd floor science classroom sinks. Domestic water to these rooms was reportedly shut off due to leakage. The investigation did not confirm the location of the leak.



RECOMMENDATIONS

Repair the piping and restore operation, to provide the water services required at sinks and other fixtures.

SCOPE OF WORK

Remove any failed piping, fittings or valves. Repair or replace as required to eliminate leaks. Pressure test the piping. Restore water operation.

Provide Dual-Height Drinking Fountains

Provide dual-height water coolers with bottle fillers.

RELATED SCOPES OF WORK

H-B-A-4022

H-ALL-P-4103				
Priority	Cost			
	\$\$\$			
Coordination by Discipline				
<input checked="" type="checkbox"/>	<input type="checkbox"/>	<input checked="" type="checkbox"/>	<input checked="" type="checkbox"/>	<input type="checkbox"/>
A	M	E	P	FP
<input type="checkbox"/>	<input type="checkbox"/>	<input type="checkbox"/>	<input type="checkbox"/>	<input type="checkbox"/>
S	LS	SC	BE	C

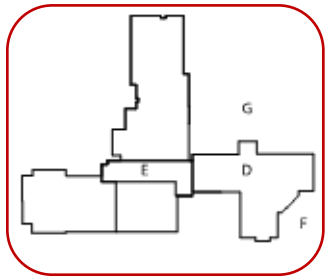

EXISTING CONDITIONS

There are currently several types of drinking fountains and water coolers throughout the building, including stainless steel, vitreous china, and vinyl, in both single and dual height applications. Ages and condition vary.

- Metal Lab C100 – single vinyl, 39”
- Boys Locker D114 – single vinyl, 35”
- Girls Locker D122 –single vinyl, 35” (presumed to match boys)
- Gym D103 – single recessed stainless steel, 38”
- Public Foyer A118 – single vinyl with bottle filler, 34.5”
- Cafeteria A123 – dual vinyl, 31” & 35”
- Corridor C124 – dual stainless, 33” & 37”
- 2nd Floor D-Wing Central Corridor – single vinyl with bottle filler, 33.5”
- 3rd Floor D-Wing Central Corridor – single vinyl with bottle filler, 32”
- 2nd Floor E-Wing Corridor – single stainless, 36”
- 3rd Floor E-Wing Corridor – dual stainless, 31” & 39”

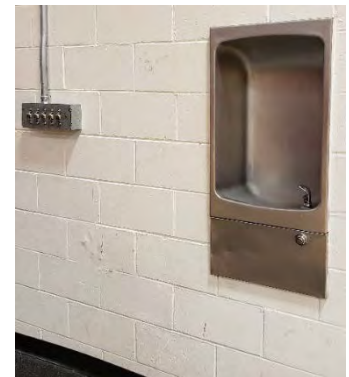

RECOMMENDATIONS

Provide dual-height drinking fountains (refrigerated water cooler type) with bottle filler, wherever existing units do not meet ADA requirements or UPC code requirements for an education occupancy type. See Appendix E for the tabulated UPC 2015 requirements versus the existing fixtures per school. Of the new drinking fountains installed, half must be installed at wheelchair height and half at standing height, and odd numbers may be rounded to either direction. This means maximum height 30 inches for wheelchair-height fountains, and allowable height range 38 to 43 inches for standing-height drinking fountains. Wherever a single drinking fountain is installed, signage must be provided indicating the location of the nearest of the other height (wheelchair height or standing height). Recommended fixture: Halsey Taylor HydroBoost Bottle Filling Station & Bi-Level ADA cooler, in Platinum Vinyl finish (stainless finish optional), with filtration.

NEXT LEVEL

In addition to the base recommendation, remove all other existing drinking fountains and water coolers, and provide a uniform installation of new dual height drinking fountains with bottle fillers. Provide a minimum of 14 units throughout the high school to meet plumbing code requirements. 2015 UPC Table 422.1 requires 1 drinking fountain per 150 people.

SCOPE OF WORK

Remove existing drinking fountains, and prepare the locations to receive new water coolers. Provide dual height water coolers with bottle fillers. Install such that means of egress are not impeded, and with the wheelchair-height side located for best access at each cooler. Install the bottle filler on the lower wheelchair-height side of the fountain. Provide blocking in walls to support units; in partition types other than masonry, provide Zurn or equal floor-mounted steel fixture carriers. Provide domestic cold-water piping with new shutoff valve to each fixture, and sanitary and vent piping. Provide power supplies, new or connection to existing. Provide architectural finishes and trim as required.

Provide Clay-Sediment Traps in Art Sinks

Sinks lack clay-sediment traps to protect sanitary piping from solids

RELATED SCOPES OF WORK

Not Applicable

H-C106-P-4104		
Priority	Cost	
	\$	
Coordination by Discipline		
<input checked="" type="checkbox"/>	<input type="checkbox"/>	<input type="checkbox"/>
A	M	E
<input type="checkbox"/>	<input type="checkbox"/>	<input type="checkbox"/>
A	M	E
<input type="checkbox"/>	<input type="checkbox"/>	<input type="checkbox"/>
S	LS	SC

EXISTING CONDITIONS

Drawing and Painting Room sinks do not have sediment traps to prevent solids from entering the sanitary waste system.

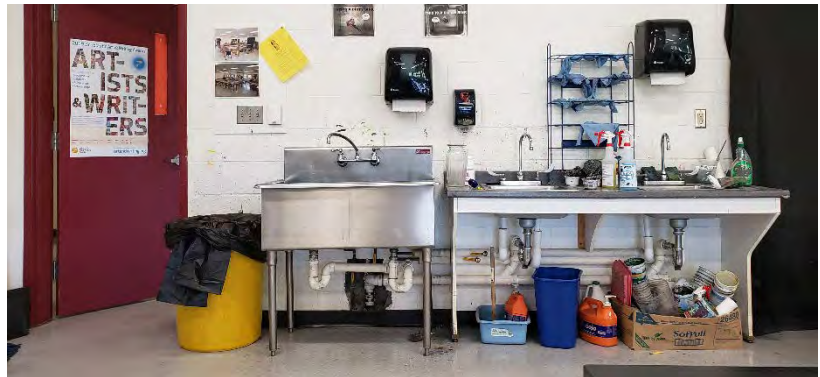

RECOMMENDATIONS

Provide sediment traps to stop heavy solids from entering the sanitary drainage system, as required by the Maine plumbing code in the UPC 2015 (Uniform Plumbing Code) chapter 1016.0 Sand Interceptors.

NEXT LEVEL

Replace sinks to comply with ADA accessibility requirements.

SCOPE OF WORK

1. Base Level: Remove existing traps and piping as necessary. Provide sediment traps.
2. Next Level: Provide architectural services to verify ADA requirements and school's needs. Remove existing sinks and piping as required. Provide ADA-compliant sinks where required. Provide sediment traps. Provide guards on piping and other surfaces within the ADA required knee spaces.

Provide Chemical Neutralizers for Photo Sinks

Piped directly to sanitary system
 Ventilation should be verified

RELATED SCOPES OF WORK

Not Applicable

H-C101-P-4105	
Priority	Cost
	\$\$
Coordination by Discipline	
<input checked="" type="checkbox"/>	<input type="checkbox"/>
<input type="checkbox"/>	<input checked="" type="checkbox"/>
<input type="checkbox"/>	<input type="checkbox"/>
<input type="checkbox"/>	<input type="checkbox"/>
<input type="checkbox"/>	<input type="checkbox"/>
S	C

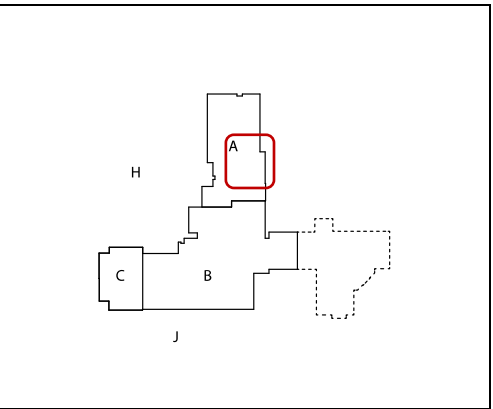

EXISTING CONDITIONS

In Darkroom C101, the sinks appear to be made of chemically resistive materials. The drain piping is ordinary PVC and is piped to drain directly into sanitary system without any treatment to neutralize or capture photography chemicals. Developer is typically alkaline; stop bath is typically acidic. One sink has a bucket underneath which is labeled as a silver trap; the bucket has an inlet tube; such waste must be handled and disposed of properly as hazardous waste. Room ventilation was existing prior to the 2004 remodel.



RECOMMENDATIONS

Verify the chemicals and quantities used and discharged to drain, and consult with the local sewer district to verify requirements. Maine’s plumbing code includes UPC 2015 (Uniform Plumbing Code); under chapter 811.0 Chemical Wastes, sub-chapter 811.8 Diluted Chemicals allows minor discharges of adequately diluted chemicals in photographic darkrooms. If dilution is acceptable to the sewer district, post dilution instructions at each sink. If treatment is required, provide a system to neutralize chemicals before they reach the sanitary drainage system. Verify adequacy of room ventilation, and modify as necessary.

SCOPE OF WORK

Post instructions as required, at each sink. If chemical treatment is required, provide either a neutralization chamber for each sink, hard-piped to the sanitary sewer system, or portable neutralization chambers into which chemicals may be poured and mixed with neutralization treatment before pouring them down the drain or otherwise disposing of them. Provide any necessary building penetrations and patching. Perform design review and testing and balancing on the ventilation systems to verify proper ventilation in accordance with current Codes; repair or modify as required.

Cape Elizabeth Schools Needs Assessment

Protect Cold Water Entrance Piping

Piping is bare and sweaty; water is rusting the pipe supports.

RELATED SCOPES OF WORK

H-B216-P-4108

H-B216-P-4106	
Priority	Cost
	\$
Coordination by Discipline	
<input type="checkbox"/>	<input type="checkbox"/>
<input type="checkbox"/>	<input checked="" type="checkbox"/>
<input type="checkbox"/>	<input type="checkbox"/>
A	M
<input type="checkbox"/>	<input type="checkbox"/>
<input type="checkbox"/>	<input type="checkbox"/>
S	LS
<input type="checkbox"/>	<input type="checkbox"/>
<input type="checkbox"/>	<input type="checkbox"/>
S	C

The diagram shows a floor plan of Mechanical Room B216. A red rectangular box highlights a specific area labeled 'F', which corresponds to the entrance piping mentioned in the project title. Other areas are labeled 'D', 'E', and 'G'.

EXISTING CONDITIONS

Mechanical Room B216: Domestic cold water piping at entrance meters and BFPs is bare, sweating, and rusting the steel supports with rust running onto floor. Insulate, and replace supports.



RECOMMENDATIONS

Insulate piping, and replace supports. Size supports to fit outside the insulation to provide continuous insulation and vapor retarder. Protect insulation with sturdy jacketing.

SCOPE OF WORK

Remove rusted or undersized floor supports and overhead hangers, providing temporary support as required. Provide supports and hangers sized to fit outside the pipe insulation. Insulate with fiberglass or other suitable piping insulation with external or integral vapor retarder; provide rigid inserts at supports to prevent compressing the insulation, and long metal outer shields between the insulation and the support. Provide sturdy outer pipe jacket and fitting system on any piping 8 feet or less above floor to prevent damage due to service activities and the school's storage; heavy PVC, aluminum, and stainless steel types are available. Insulate bodies of valves and strainers to the extent practical, leaving bare the water meters and fittings requiring frequent service such as BFP test ports. Provide extensions for ball valve handles so the valve bodies can be insulated to full thickness without interfering with handle operation. Miter and seal insulation at interruptions.

Protect Mech Rm. from Water Entrance Flooding

Water backflow preventers spill on floor with inadequate drainage

RELATED SCOPES OF WORK

Not Applicable

H-B216-P-4107				
Priority	Cost			
	\$			
Coordination by Discipline				
<input checked="" type="checkbox"/> <input type="checkbox"/> <input type="checkbox"/> <input checked="" type="checkbox"/> <input type="checkbox"/> A M E P FP				
<input type="checkbox"/>	<input type="checkbox"/>	<input type="checkbox"/>	<input type="checkbox"/>	<input type="checkbox"/>
S	LS	SC	BE	C

EXISTING CONDITIONS

Mechanical Room B216: The backflow preventer (BFP) at the building water metering entrance prevents building water being pushed or pulled out into the city main, whenever the pressure in the building is greater than the pressure in the city's outdoor piping. This could occur for example, during a nearby fire when the pumper truck draws a lot of water from the hydrants. The most protective type is reduced pressure zone (RPZ), with a water vent that intentionally discharges during a pressure condition (or when one of the inner check valves is fouled with dirt and sticks open).

The 4-inch RPZ-type BFP, Febco model 825-YD, lacks sufficient drainage and could flood this and adjacent rooms. The nearby floor drain (FD) and its piping are small, and made smaller by the 2-inch sprinkler drain piped through the grate. There are no protections such as a water-sensing alarm or containment dam. Febco indicates 520 GPM vent discharge at the 80 psi city pressure, and suggests an 8-inch pipe-size FD for this flow, or 6-inch for nearly this flow.



RECOMMENDATIONS

Provide proper drainage, and water sensing alarm, or change BFP type and provide more protection elsewhere.

SCOPE OF WORK

- Level 1: Provide a Febco air-gap fitting on the vent outlet, and hard-pipe the vent to above the floor drain. Provide a raised funnel on the floor drain, or a raised dam around the entire water entrance area, to contain small flows. Provide a discharge flow sensing alarm wired to the building management system to alert maintenance personnel. This solution would not prevent flooding from a full discharge, but would contain smaller flows and nuisance drips.
- Level 2: Provide Level 1, plus an additional pipe across the room to drain outdoors.
- Level 3: Provide Level 1, plus replace the floor drain system including a large floor drain with 8-inch piping, or at least 6-inch if there is no existing 8-inch main in the building. Run this piping to an existing main of at least this size. Cut and patch floors and other building elements as required.
- Change BFP Type: Verify with the local Water District whether the building hazards to the water supply require an RPZ type at the entrance. In some buildings, a dual-check type (which doesn't have the vent) is sufficient. Changing to a dual-check would require protecting every potential source of cross-contamination in the building with local BFPs, vacuum breakers, and air gaps, as required by Code and the Water District; some deficiencies such as at janitor closet faucets have been noted in other work items. Improving local protection would better protect building occupants, whereas the main BFP only protects the city main.

Replace Piping Insulation in Mech. B216

Insulation is old, and is ineffective on domestic cold water piping

RELATED SCOPES OF WORK

H-B216-P-4106
H-B216-M-4073

H-B216-P-4108				
Priority	Cost			
	\$			
Coordination by Discipline				
<input type="checkbox"/>	<input checked="" type="checkbox"/>		<input type="checkbox"/>	<input checked="" type="checkbox"/>
A	M	E	P	FP
<input type="checkbox"/>	<input type="checkbox"/>	<input type="checkbox"/>	<input type="checkbox"/>	<input type="checkbox"/>
S	LS	SC	BE	C

EXISTING CONDITIONS

Mechanical Room B216: Overhead plumbing and heating piping in most of this room is insulated with an old canvas jacketing, including on elbows. On the 4" cold water main the elbows have stains suggesting mold or other growth.

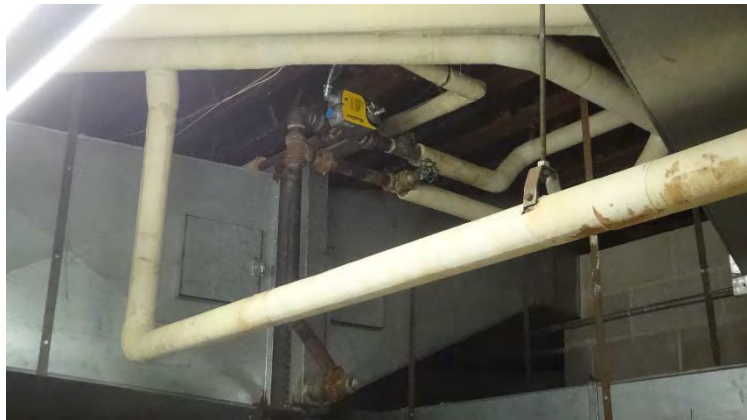

RECOMMENDATIONS

Replace insulation, and replace hanger bands so the insulation and vapor barrier are continuous through hangers.

SCOPE OF WORK

Abatement: Verify any previous hazardous materials report, perform survey if needed, and abate any hazardous materials properly.

Remove insulation. Remove undersized hangers, providing temporary support as required. Provide hangers sized to fit outside the pipe insulation. Insulate with fiberglass or other suitable piping insulation with external or integral vapor retarder; provide rigid inserts at supports to prevent compressing the insulation, and long metal outer shields between the insulation and the support. Insulate to full thickness the bodies of valves and strainers to the extent possible, leaving bare only the fittings requiring frequent service such as balancing valve test ports. Provide extensions for ball valve handles so the valve bodies can be insulated to full thickness without interfering with handle operation. Miter and seal insulation at interruptions.

Related work items include an item to replace the HVAC equipment and its piping and the old leaky valves, and an item to insulate bare sweating piping at the domestic water entrance.

Emergency Eyewash Piping in Mech Rm B216

Mixing valve not kept active and hot
Drain standpipe trap not protected

RELATED SCOPES OF WORK

H-ALL-P-4099
H-B325-P-4110

H-B216-P-4109	
Priority	Cost
	\$
Coordination by Discipline	
<input type="checkbox"/>	<input type="checkbox"/>
<input type="checkbox"/>	<input checked="" type="checkbox"/>
<input type="checkbox"/>	<input type="checkbox"/>
A	M
<input type="checkbox"/>	<input type="checkbox"/>
<input type="checkbox"/>	<input type="checkbox"/>
S	LS
<input type="checkbox"/>	<input type="checkbox"/>
SC	BE
<input type="checkbox"/>	<input type="checkbox"/>
C	C

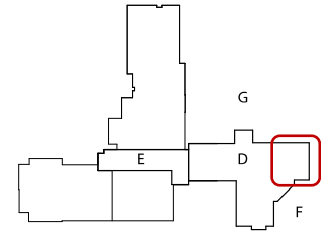

EXISTING CONDITIONS

Mechanical Room B216: An emergency eyewash in the nurse's COT room on the 3rd floor has a water mixing valve and an overhead indirect waste standpipe in this room. The hot water piping into the valve lacks recirculated hot water piping to keep the hot water at temperature and not stagnant, and the hot water piping lacks insulation. The indirect waste standpipe serving the eyewash drain lacks a trap primer to protect the trap from drying out, and lacks vent piping.

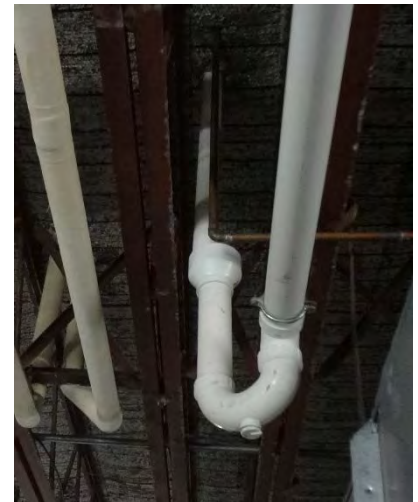

RECOMMENDATIONS

Provide recirculated hot water piping with return to the central water heater, to keep the hot water at temperature and not stagnant. Insulate the hot water and recirculated hot water piping, and the tepid water supply piping up to the 3rd floor. Provide a trap primer to protect the indirect waste standpipe from drying out. Provide sanitary venting.

SCOPE OF WORK

Provide copper recirculated hot water piping from the nearest recirculation piping main to the hot water supply piping near the mixing valve, with a balancing valve. Provide hangers and supports for the piping. Insulate the recirculation piping, and the existing hot, cold, and tepid water piping associated with the mixing valve. Insulate the mixing valve body. Provide a trap primer with discharge into the indirect waste standpipe; the primer may either be a mechanical type located at a frequently-used fixture above the 3rd floor, or an electronic trap primer in the mechanical room. Provide sanitary venting for the standpipe as required by Code, consisting of piping to a nearby existing vent pipe riser stack to outdoors, or the local Plumbing Inspector may allow using a "Studor" type air admittance valve.

COT Room B325 - Eyewash Issues

Water splashes onto floor
Piping lacks sleeves and firestop

RELATED SCOPES OF WORK

H-D-A-4028
H-B216-P-4109

H-B325-P-4110				
Priority	Cost			
	\$			
Coordination by Discipline				
<input checked="" type="checkbox"/>	<input type="checkbox"/>	<input type="checkbox"/>	<input checked="" type="checkbox"/>	<input type="checkbox"/>
A	M	E	P	FP
<input type="checkbox"/>	<input type="checkbox"/>	<input type="checkbox"/>	<input type="checkbox"/>	<input type="checkbox"/>
S	LS	SC	BE	C

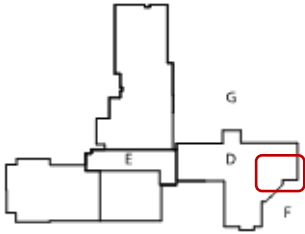

EXISTING CONDITIONS

The emergency eyewash has a center hub, off which water splashes onto the floor when the water is run. The eyewash appears clean and little used but may not comply with ADA accessibility requirements. The weekly inspection hang-tag has not been filled out, so frequency of past testing is unknown. The PVC drain and 1/2" tepid water down thru the floor lack sleeves and firestop.

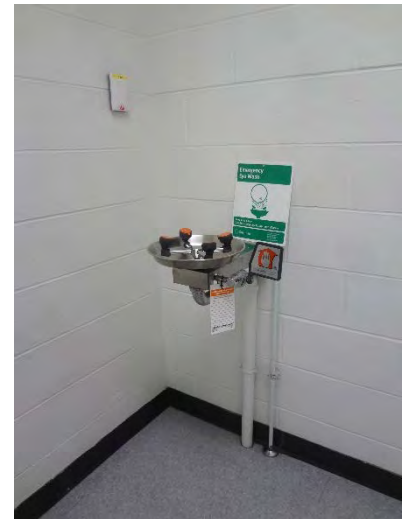
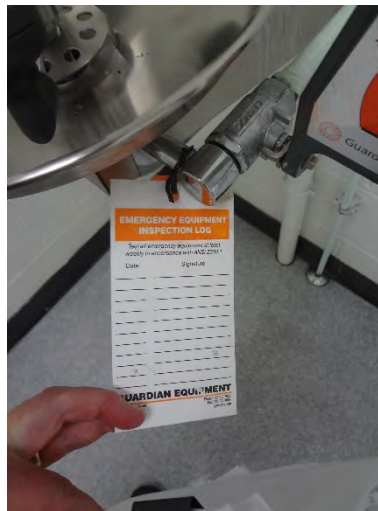

RECOMMENDATIONS

Replace eyewash as necessary to comply with ADA and to eliminate splashing. Provide sleeves and firestop on piping through the floor.

SCOPE OF WORK

Remove existing eyewash. Provide new eyewash or eye/face wash. Provide sleeves and firestop on piping through the floor.

Nurses Assist B322 - Convactor Pipe Seal and Firestop

Piping lacks sleeves and firestop

RELATED SCOPES OF WORK

H-ALL-FP-4119

H-B325-P-4110					
Priority	Cost				
	\$				
Coordination by Discipline					
<input checked="" type="checkbox"/>	<input checked="" type="checkbox"/>		<input type="checkbox"/>	<input type="checkbox"/>	<input type="checkbox"/>
A	M		E	P	FP
<input type="checkbox"/>	<input type="checkbox"/>		<input type="checkbox"/>	<input type="checkbox"/>	<input type="checkbox"/>
S	LS	SC	BE	C	

EXISTING CONDITIONS

The convectors in this area of the building are aged and have been painted more than once. The heating water down thru the floor lack sleeves and firestop. The room is above the 2nd-floor mechanical and storage room.

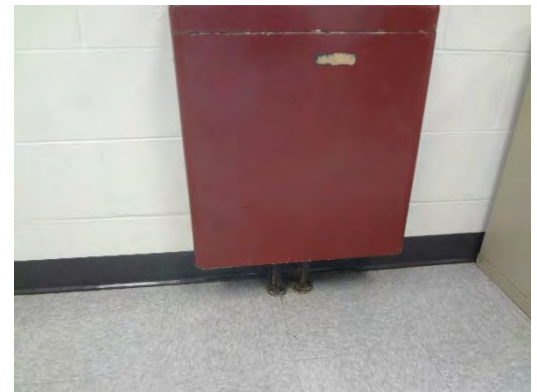

RECOMMENDATIONS

Provide firestop on piping through the floor, to restore the fire rating and watertightness of the floor assembly.

SCOPE OF WORK

Prepare openings around pipes as required to allow proper firestop and sealing; provide sleeves if required by the firestop system's UL listing. Provide a UL-listed firestop with water-sealing properties, on each pipe through the floor. Provide chromed metal escutcheons on the piping to conceal and protect the firestop where pipes are exposed. For other locations which are in potentially damp or wet locations, the escutcheon base metal shall be brass or stainless steel.

Plumbing Venting and Trap Primer

Washing machine standpipe and other fixture drain and venting issues

RELATED SCOPES OF WORK

H-A126-A-4002

H-A126-P-4111				
Priority	Cost			
	\$			
Coordination by Discipline				
<input checked="" type="checkbox"/> A <input type="checkbox"/> M <input type="checkbox"/> E <input checked="" type="checkbox"/> P <input type="checkbox"/> FP				
<input type="checkbox"/>	<input type="checkbox"/>	<input type="checkbox"/>	<input type="checkbox"/>	<input type="checkbox"/>
S	LS	SC	BE	C

EXISTING CONDITIONS

Washing machine standpipe, dishwasher drain, and walk-in freezer standpipe lack venting.



RECOMMENDATIONS

Provide venting as required by the local Plumbing Inspector. Venting protects traps from being siphoned out and losing their water seal, thus preventing sewer gas entry into the room.

SCOPE OF WORK

Consult with the Plumbing Inspector to verify venting requirements. Provide vent piping, or if piping is impractical provide air admittance valves if the Inspector will allow them.

Kitchen Sinks for Proper Sanitation

Kitchen sinks lack proper drainage and separation of functions

RELATED SCOPES OF WORK

H-A126-A-4002

H-A126-P-4112				
Priority	Cost			
	\$			
Coordination by Discipline				
<input checked="" type="checkbox"/>	<input type="checkbox"/>	<input checked="" type="checkbox"/>	<input checked="" type="checkbox"/>	<input type="checkbox"/>
A	M	E	P	FP
<input type="checkbox"/>	<input type="checkbox"/>	<input type="checkbox"/>	<input type="checkbox"/>	<input type="checkbox"/>
S	LS	SC	BE	C

EXISTING CONDITIONS

Kitchen sinks do not provide proper separation of dishwashing and other unsanitary functions from food preparation such as washing vegetables to be served uncooked. The single 3-bay lacks indirect waste and is piped directly to the sanitary system. The electric sink booster heater for warewashing sanitation appears to be out of use with plugged-up supply and return connections at the bottom of the sink, but there doesn't appear to be an alternative such as a chemical sanitizing system. The bowl with the booster heater is missing its overflow outlet fitting.



RECOMMENDATIONS

Provide adequate separate sinks, indirect wastes, and functional sink booster heater for proper sanitation.

SCOPE OF WORK

Provide additional sinks to separate functions. For the sink used for food washing, pipe the drains to indirect waste with air gap to prevent the backup of sewage or gases into the sink, as required by Maine's Uniform Plumbing Code 2015 Chapter 801.3.3 Food Handling Fixtures. Replace missing overflow outlet fitting(s). Remove the booster heater and provide new with accessories as required, to meet the manual warewashing sanitation requirements of the Maine Food Code.

Roof Reinforcement – Area A

Existing roof cannot withstand snow loading

RELATED SCOPES OF WORK

H-ALL-BE-4034

H-A-S-4114				
Priority	Cost			
	\$\$			
Coordination by Discipline				
<input checked="" type="checkbox"/>	<input checked="" type="checkbox"/>		<input checked="" type="checkbox"/>	<input checked="" type="checkbox"/>
A	M	E	P	FP
<input checked="" type="checkbox"/>	<input type="checkbox"/>	<input type="checkbox"/>	<input type="checkbox"/>	<input type="checkbox"/>
S	LS	SC	BE	C

EXISTING CONDITIONS

The Cape Elizabeth High School Roof on Area A consists of open web joists spaced at 3ft on center, supported by 8” reinforced CMU bearing walls. There are five different areas of concern within area A. There are 10H2 joists above the corridor (C124) that span 12’-10” and do not have sufficient capacity for ASCE 7-10 prescribed flat roof snow loading of 35psf plus the drift loading. Next are the 18H6 joists above the Green room (C132). These joists span approximately 27’-8” and are not sufficiently sized for snow loading. The third area of concern is above the prop storage closet (C130). These 22H8 joists span 35’-4” and again, they do not have sufficient capacity for snow loading. The 12H3 joists above the Band room vestibule (C134) span 18’-1” and are not adequately sized. Lastly, the 20H7 joists above the music office (C135) span 35’-1” and are also not adequately sized.

RECOMMENDATIONS

The roof above Area A was replaced in 2012. It cannot withstand the ASCE 7-10 prescribed snow loading of 35psf and therefore Colby Company recommends that the joists noted below, be reinforced as shown on the attached drawings.

Scope of Work

The scope of work includes reinforcing the joists with round bars and/or double angles to increase the capacity of the joists where noted. Ceiling tiles need to be temporarily removed while this work is completed.

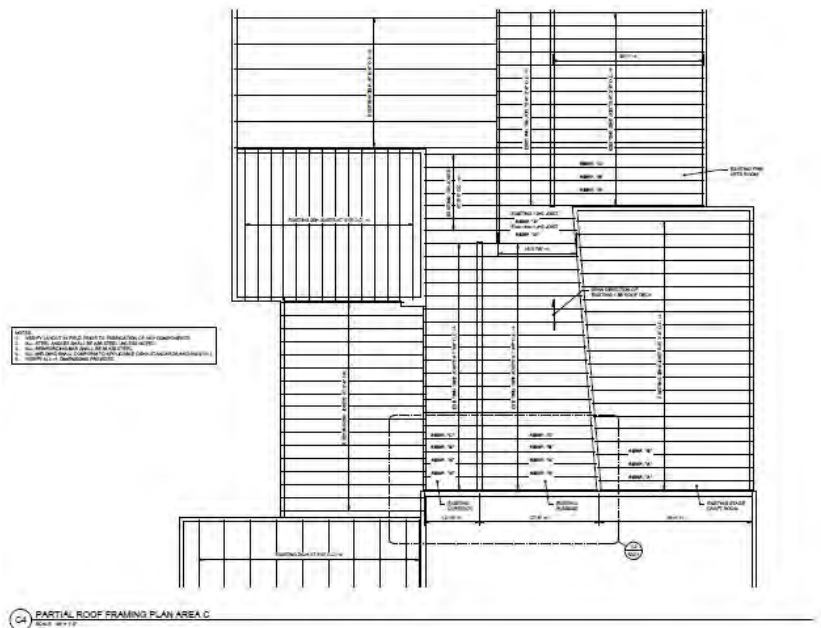

Security: Weak Points

RELATED SCOPES OF WORK H-ALL-SC-4055

H-ALL-SC-4115				
Priority	Cost			
	TBD			
Coordination by Discipline				
<input checked="" type="checkbox"/>	<input checked="" type="checkbox"/>	<input checked="" type="checkbox"/>	<input type="checkbox"/>	<input type="checkbox"/>
A	M	E	P	FP
<input type="checkbox"/>	<input type="checkbox"/>	<input checked="" type="checkbox"/>	<input type="checkbox"/>	<input type="checkbox"/>
S	LS	SC	BE	C

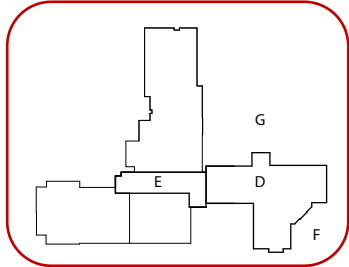

EXISTING CONDITIONS

- Once entry is gained to the Main Office B334 space, access can be gained to the rest of the school via the two conference rooms B329 and B328 if these doors are not secured. On multiple site visits, these doors were observed to be unsecured. The adjacent Nurse’s Office suite as well as the Athletic Director’s Office suite are also potential access points if doors are not secured. These doors were found to be secured on most visits.
- Stairs and Secondary Vestibule Doors: During site observations, as well as during faculty interviews, it was noted that exterior perimeter doors at stairways and secondary vestibules are often propped open to alleviate the need to re-enter at the secured main entry point.
- Access security devices vary across exterior entry doors, ranging from no presence of an auxiliary system; to a key-code punch pad; to a credential scanner.
- At Main Office B334, existing security monitor does not appear to be in use.

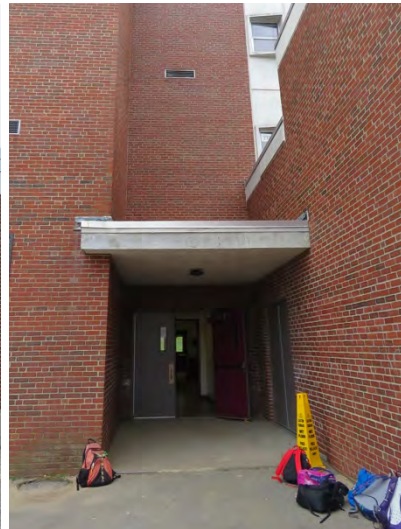

Notes on Costing: Given that the scope of this work may vary greatly, please see costing sheet and associated back-up for relevant unit pricing.

Cape Elizabeth Schools Needs Assessment

RECOMMENDATIONS

- The design team recommends installing closers on doors to conference rooms B329 and B328 from B334, Main Office. Hardware should be upgraded to be locked from B334 side as default. (The design team understands that the Athletic Director and Nurse's Offices would be accessible only if offices are occupied. Office occupants are responsible for securing doors in the event of a security breach – otherwise these doors would be locked from B334 side.)
- The design team recommends stairs and secondary vestibule doors not be propped open. A remote door-bell system could be implemented at key locations to allow those who use doors frequently, but may not have credentials, to buzz in at locations other than the main entry. Alternately, as a way to monitor only, wireless door contacts could be installed. These systems would need to be coordinated with IT systems and practices. The design team recommends the school consider the use of the existing security monitor in their security protocol.

NEXT LEVEL

Upgrade security measures for all exterior entry doors and stair doors to a universal credentialed key-card system. Install door contacts that alert security when doors are propped open.

Security Camera Improvements

RELATED SCOPES OF WORK

Not Applicable

H-ALL-SC-4116				
Priority	Cost			
	\$\$			
Coordination by Discipline				
<input checked="" type="checkbox"/>	<input type="checkbox"/>	<input checked="" type="checkbox"/>	<input type="checkbox"/>	<input type="checkbox"/>
A	M	E	P	FP
<input type="checkbox"/>	<input type="checkbox"/>	<input checked="" type="checkbox"/>	<input checked="" type="checkbox"/>	<input type="checkbox"/>
S	LS	SC	BE	C

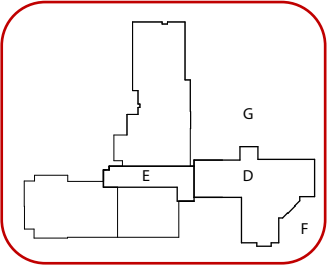

EXISTING CONDITIONS

Existing security camera coverage is sporadic and incomplete. Additionally, there are software issues with the current system which is easier to operate from Windows systems than from MacOS systems.

RECOMMENDATIONS

Engage a security contractor to perform a complete security analysis of the existing system, including camera positions, types, headend equipment (video recorders, switches, etc), and software and to develop a plan for phased implementation of increased security camera coverage and control.

Consider implementation of “intelligent” video monitoring. Intelligent video combines analytics and algorithms with video footage. To look for security threats in real time and notify onsite security personnel.

If broader renovations of an area or wing are considered as part of another Work Item, determine if this is an appropriate time to revamp the security system in that area.

Pool and Locker Room Automatic Fire Sprinkler Protection

The swimming pool and associated locker and equipment spaces do not have automatic fire sprinkler system protection.

RELATED SCOPES OF WORK

Not Applicable

H-C-FP-4117	
Priority	Cost
	\$\$\$\$
Coordination by Discipline	
<input checked="" type="checkbox"/>	<input type="checkbox"/>
<input type="checkbox"/>	<input checked="" type="checkbox"/>
A	M
<input type="checkbox"/>	<input checked="" type="checkbox"/>
S	LS
<input type="checkbox"/>	<input type="checkbox"/>
E	SC
<input type="checkbox"/>	<input type="checkbox"/>
P	BE
<input type="checkbox"/>	<input type="checkbox"/>
FP	C
<input type="checkbox"/>	<input type="checkbox"/>

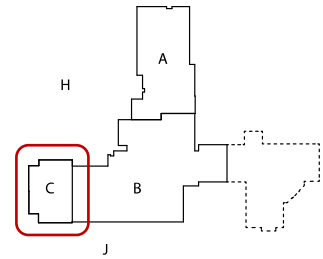

EXISTING CONDITIONS

Area C including the swimming pool, exercise room, and associated spaces appears to have been added on to the remainder of the Building (Area B and on). The pool area (Area C) is not separated by a fire wall from the remainder of the building (Area B and on) and is therefore considered as a single building. For the building, including the school, to be considered as 'sprinkler protected', an NFPA 13 compliant system must be installed throughout.

Area B, with the exception of the pool locker and equipment rooms, is protected by a wet pipe automatic sprinkler system. The riser located in Janitor Closet A115 appear to provide coverage throughout both Area A and Area B.

RECOMMENDATIONS

Install an NFPA 13 compliant sprinkler system throughout Area C including the swimming pool and associated locker rooms and equipment spaces located adjacent to the pool in Area B.

NEXT LEVEL

Further investigation will be required to determine if the existing wet pipe automatic sprinkler system in Area B can support extension of the system for protection of Area C. The existing system will require sufficient water supply pressure and volume to support the extended piping distances. NFPA 13 also provides restrictions on the area of coverage for a single system which will require consideration. If the existing Area B system hydraulic design is not sufficient, or the area limitation of NFPA 13 will not allow expansion to Area C then a new sprinkler riser and possibly new underground service will be required.

SCOPE OF WORK

Provide sprinklers, piping, hangers, valves, and required trim to provide an NFPA 13 compliant automatic sprinkler system protection throughout all areas of Area C and the adjacent lockers and equipment spaces in Area B.

Fire Alarm Equipment Location Smoke Detection

Provide smoke detection for fire alarm equipment in normally unoccupied areas.

RELATED SCOPES OF WORK

Not Applicable

H-D115-FP-4118				
Priority	Cost			
	\$			
Coordination by Discipline				
<input checked="" type="checkbox"/>	<input type="checkbox"/>	<input checked="" type="checkbox"/>	<input type="checkbox"/>	<input checked="" type="checkbox"/>
A	M	E	P	FP
<input type="checkbox"/>	<input checked="" type="checkbox"/>	<input type="checkbox"/>	<input type="checkbox"/>	<input type="checkbox"/>
S	LS	SC	BE	C

EXISTING CONDITIONS

The existing fire alarm system has control equipment such as notification appliance circuit expander panels distributed throughout.



Not all areas with fire alarm control equipment installed in normally unoccupied areas, such as electrical closets, are provided with smoke detection as required by NFPA 72.

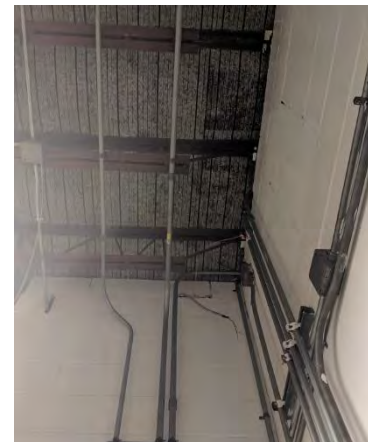

RECOMMENDATIONS

Provide smoke detection for normally unoccupied areas where fire alarm control equipment is installed.

SCOPE OF WORK

Provide new smoke detector device, circuiting, and programming required for interconnection to existing fire alarm system. The system modifications will require reacceptance testing of all directly affected points as well as 10% of the existing system, not to exceed 50 points.

Firestop Penetrations

Penetrations by utilities, and other openings in rated assemblies

RELATED SCOPES OF WORK

- H-ALL-LS-4053
- H-ALL-LS-4012
- H-B325-P-4110

H-ALL-FP-4119				
Priority	Cost			
	\$\$			
Coordination by Discipline				
<input checked="" type="checkbox"/>	<input checked="" type="checkbox"/>	<input checked="" type="checkbox"/>	<input checked="" type="checkbox"/>	<input checked="" type="checkbox"/>
A	M	E	P	FP
<input checked="" type="checkbox"/>	<input checked="" type="checkbox"/>	<input type="checkbox"/>	<input type="checkbox"/>	<input type="checkbox"/>
S	LS	SC	BE	C

EXISTING CONDITIONS

Many walls and floors throughout the building are penetrated by various building systems including, but not limited to, fire protection piping, plumbing systems, HVAC systems, and electrical conduit. Many of these penetrations are not sufficiently firestopped to meet the rating of the assembly being penetrated. Several penetrations are currently firestopped, but insufficiently. There are also several empty openings through walls and floors where building systems once penetrated, but have since been removed.

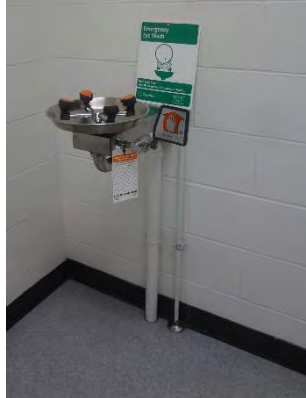

RECOMMENDATIONS

Provide firestopping to meet the rating of the building assembly being penetrated, throughout building.

SCOPE OF WORK

Provide architectural and engineering services to determine the locations of fire and smoke rated building assemblies, and to determine the type of firestop system suitable at each type of penetration. Provide firestopping for existing building systems that will remain. Provide firestopping for openings which are empty due to removal of building systems or other reasons. Provide firestopping for new building systems once in place.

Replace Roof Drains

Retrofit-type drains restrict flow area
 Replace when roof repairs are made

RELATED SCOPES OF WORK

Not Applicable

H-ALL-P-4120				
Priority	Cost			
	\$			
Coordination by Discipline				
<input checked="" type="checkbox"/>	<input checked="" type="checkbox"/>	<input type="checkbox"/>	<input checked="" type="checkbox"/>	<input type="checkbox"/>
A	M	E	P	FP
<input type="checkbox"/>	<input type="checkbox"/>	<input type="checkbox"/>	<input type="checkbox"/>	<input type="checkbox"/>
S	LS	SC	BE	C

EXISTING CONDITIONS

Some of the existing roof drains, such as above the Gymnasium, are a retrofit type typically installed by roofing contractors when they are replacing roof membranes and adding insulation. They have a flat plate, and a tube that inserts through the existing drain bowl and into the pipe. Roofers also often allow the roof membrane to overlap the drain opening, further restricting water flow.

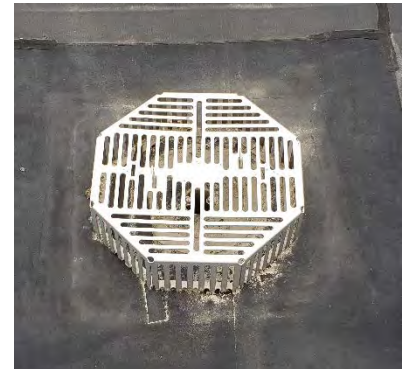

RECOMMENDATIONS

When roofing repairs or replacement, or HVAC equipment replacement, are performed, replace the roof drains. Provide full replacement of the existing original drain body at the roof structural deck level, as well as the retrofit drain at the roof surface.

NEXT LEVEL

Provide secondary drainage systems if the roof structure cannot support standing water.

SCOPE OF WORK

Base Level: Remove existing original roof drain body, retrofit roof drain, and piping as necessary. Provide roof drains with cast iron bodies, deck clamps and other accessories, and aluminum or plastic strainer domes. Extend piping to the drain outlet connections. Insulate drain bodies and piping below the roof

Next Level: Provide architectural and engineering services to determine the adequacy of the roof structure to support standing water if a roof drain or piping is clogged. Base the design on current structural and plumbing codes. Provide secondary drainage system as required by Code if roof cannot support the water.

Cape Elizabeth Schools Needs Assessment

Replace Hot Water Tank

Signs of leakage

RELATED SCOPES OF WORK

Not Applicable

H-C115-M-4121				
Priority	Cost			
	\$			
Coordination by Discipline				
<input checked="" type="checkbox"/>	<input checked="" type="checkbox"/>	<input type="checkbox"/>	<input checked="" type="checkbox"/>	<input type="checkbox"/>
A	M	E	P	FP
<input checked="" type="checkbox"/>	<input type="checkbox"/>	<input type="checkbox"/>	<input type="checkbox"/>	<input type="checkbox"/>
S	LS	SC	BE	C

EXISTING CONDITIONS

Existing hot water tank in the boiler room shows signs of leakage. Unit may require resizing for current and future building demand.



RECOMMENDATIONS

Provide new hot water tank.

SCOPE OF WORK

Provide engineering services to determine building hot water demand to size a replacement hot water tank. Provide connection modifications to connect to existing. Replace leaking or inadequate piping with new, including insulation. Provide structural support modifications as required to support a new tank.

Secure Covered Storage Below Bleachers

RELATED SCOPES OF WORK
H-NEW-A-4025

H-NEW-A-4122					
Priority			Cost		
			\$		
Coordination by Discipline					
<input checked="" type="checkbox"/>	<input checked="" type="checkbox"/>	<input checked="" type="checkbox"/>	<input checked="" type="checkbox"/>	<input checked="" type="checkbox"/>	<input checked="" type="checkbox"/>
A	M	E	P	FP	
<input checked="" type="checkbox"/>	<input checked="" type="checkbox"/>	<input checked="" type="checkbox"/>	<input checked="" type="checkbox"/>	<input checked="" type="checkbox"/>	<input checked="" type="checkbox"/>
S	LS	SC	BE	C	

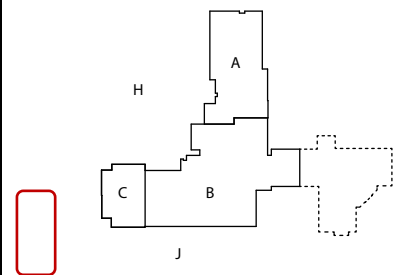

EXISTING CONDITIONS

Increased storage for athletic equipment is a need expressed by staff during stakeholder interviews. Some existing storage space is currently occupied with equipment that requires secure storage, but not climate control. Creating dedicated non-climate-controlled storage near the athletic fields would allow such items to move out of more valuable interior, climate-controlled storage.

RECOMMENDATIONS

Staff members noted that one possible location is below the existing Hannaford Field bleachers. This space is not currently utilized and could fairly easily accommodate secure storage.

Coordinate extent of storage with Work Item H-NEW-A-4025, New Field House.



Example of covered storage from Bates College.

SCOPE OF WORK

Provide wire mesh partitions with secured gates at each end. Partitions to be nominally 8' high. Provide utility lighting as required for general illumination.

APPENDIX B – SITE PHOTOS



Figure A1: 1934 Building – Cast Stone Sill Damage (EM)



Figure A2: 1934 Building – Cast Stone Sill Damage (EM)



Figure A3: Failing Precast Window Sill (EM)



Figure A4: Failing Precast Window Sill (EM)



Figure A5: Failing Precast Window Sill (EM)



Figure A6: Failing Precast Window Sill (EM)



Figure A7: Failing Precast Window Sill (EM)



Figure A8: Failing Precast Window Sill (EM)



Figure A9: Failing Precast Window Sill (EM)



Figure A10: Failing Joints at Precast Window Head (EM)



Figure A11: Failing Precast Window Sill (EM)



Figure A12: Brick Needs Repointing (EM)



Figure A13: Water Spill and Masonry Damage at Window Sill (EM)



Figure A14: Flooring Damage at Band Room (EM)



Figure A15: 1934 Building – Exterior Wood Rot (EM)



Figure A16: 1934 Building – Exterior Wood Rot (EM)



Figure A17: Skylight Conditions Issues (EM)



Figure A18: Skylight Conditions Issues (EM)



Figure A19: Skylight Conditions Issues (EM)



Figure A20: Skylight Conditions Issues (EM)



Figure A21: Sealant Issues at Window Sill (EM)



Figure A22: Exterior Wall Condition (EM)



Figure A23: Degraded Masonry Weep (EM)



Figure A24: Crack at Precast Window Sill (EM)

Figure A25: Not used

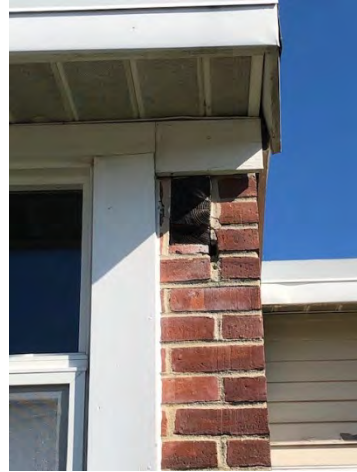

Figure A26: Missing Mortar at Brick/Wood Intersection (EM)



Figure A27: Exterior Wall Mastic Staining (EM)



Figure A28: Crack at Concrete Foundation and Brick (EM)



Figure A29: Non-Compliant Egress Door (EM)



Figure A30: Missing Mortar at Brick/Concrete Intersection (EM)



Figure A31: Water Staining and Biological Growth below Window (EM)



Figure A32: Damaged Sign (EM)



Figure A33: Sun Damaged Sign (EM)

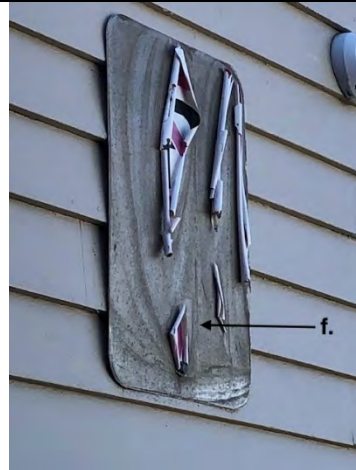

Figure A34: Damaged Sign (EM)



Figure A35: Exposed Outlet (non-GFCI) (EM)



Figure A36: Unsealed Wall Penetration (EM)



Figure A37: Non-Compliant Steps (EM)



Figure A38: Masonry Repointing (EM)



Figure A39: Stair Riser Height – Life Safety Compliance Issue (EM)



Figure A40: 1934 Building – Exterior Wall Condition (EM)



Figure A41: 1934 Building – Exterior Wall Water Staining (EM)



Figure A42: 1934 Building – Spalled Concrete at Foundation (EM)



Figure A43: 1934 Building – Spalled Concrete at (EM) Foundation



Figure A44: 1934 Building – Rusted Column Bases (EM)



Figure A45: 1934 Building – Cracked Brick Paving (EM)

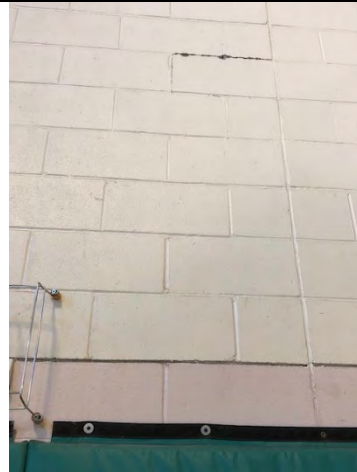

Figure A46: CMU Cracks at Gymnasium (EM)

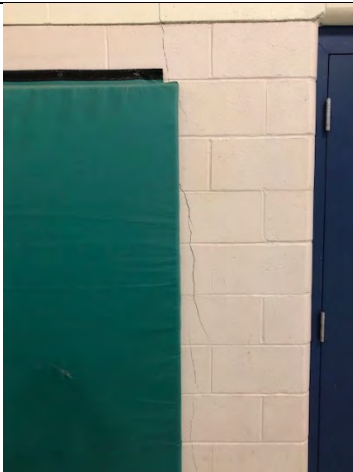

Figure A47: CMU Cracks at Gymnasium (EM)

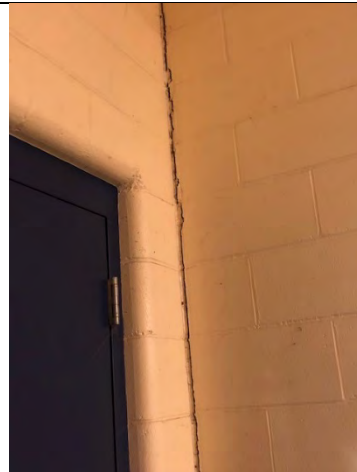

Figure A48: CMU Cracks at Gymnasium (EM)

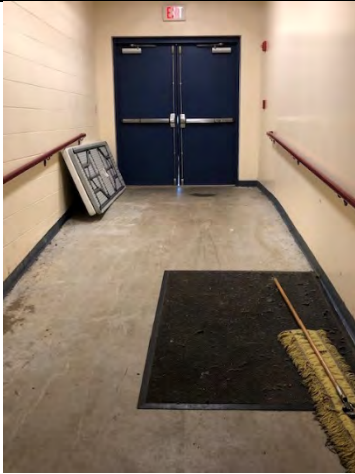

Figure A49: Weatherstripping at Door #20 (EM)



Figure A50: Buckling at Floor Ramp (EM)

Figure A51: Not used

Figure A52: Not used



Figure A53: Non-ADA Protruding Object at Room E109 (EM)



Figure A54: Life Skills – No Exhaust Hood at Range (EM)



Figure A55: Life Skills – Non-ADA Compliant Sink (EM)

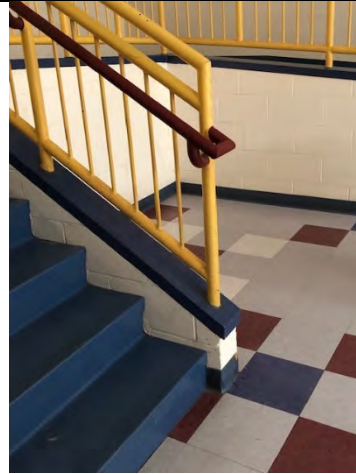

Figure A56: Stair Handrail – Life Safety Compliance Issues (EM)



Figure A57: Locker Room Lacks Fire Separation from Boiler Room (EM)

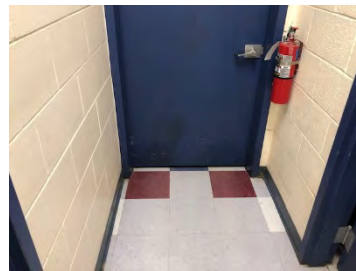

Figure A58: Non-ADA Compliant Door Approach (EM)

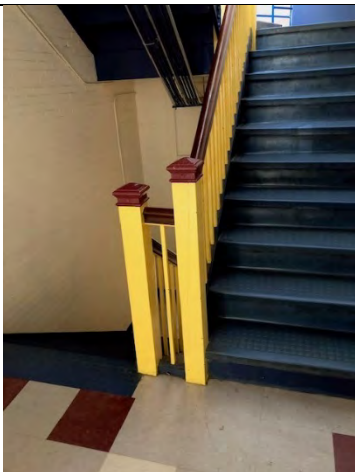

Figure A59: Stair Handrail – Life Safety Compliance Issues (EM)

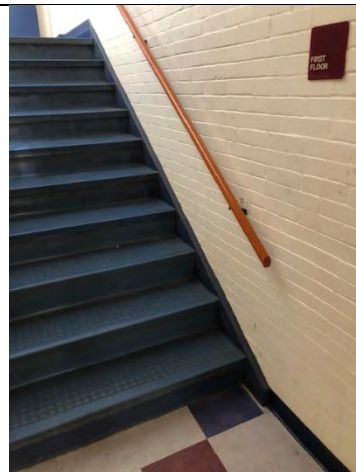

Figure A60: Stair Handrail – Life Safety Compliance Issues (EM)



Figure A61: Stair Handrail – Life Safety Compliance Issues (EM)



Figure A62: Non-ADA Compliant Door Threshold (EM)



Figure A63: Non-ADA Compliant Elevator Lobby (EM)



Figure A64: Site Issues at Middle School Ballfield (EM)

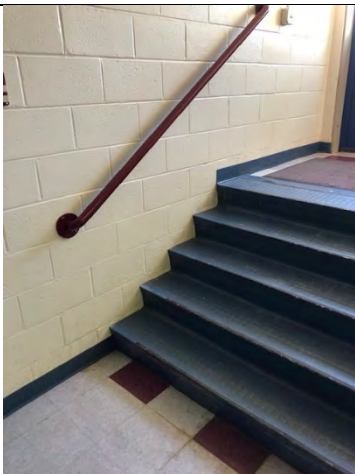

Figure A65: Stair Handrail – Life Safety Compliance Issues (EM)



Figure A66: Stair Handrail – Life Safety Compliance Issues (EM)

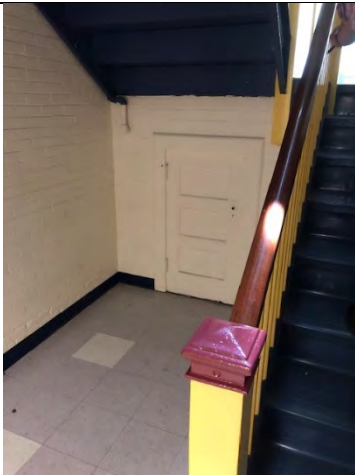

Figure A67: Storage below egress stair – Life Safety Compliance Issue (EM)



Figure A68: Window Located Adjacent to Exhaust (EM)



Figure A69: Vegetative Growth over EPDM Roofing (EM)

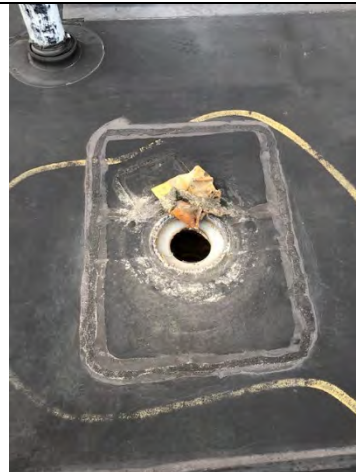

Figure A70: Roof Drain without Strainer Cover (EM)



Figure A71: Non-ADA Compliant Wall Lockers (EM)



Figure A72: Non-ADA Compliant Sink (EM)



Figure A73: Non-ADA Compliant Sink Waste Trap (EM)



Figure A74: Non-ADA Compliant Sink (EM)



Figure A75: Storage below egress stair – Life Safety Compliance Issue (EM)

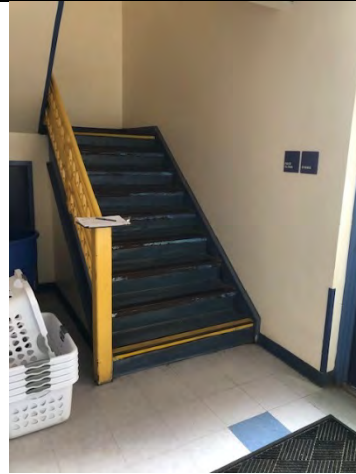

Figure A76: Stair Handrail – Life Safety Compliance Issues (EM)

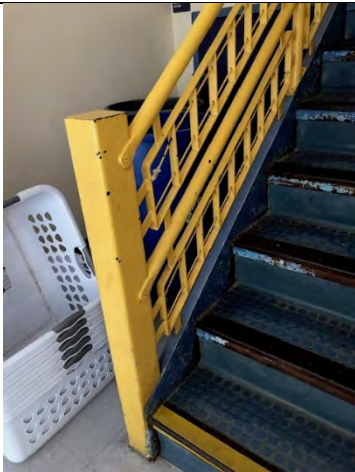

Figure A77: Stair Handrail – Life Safety Compliance Issues (EM)

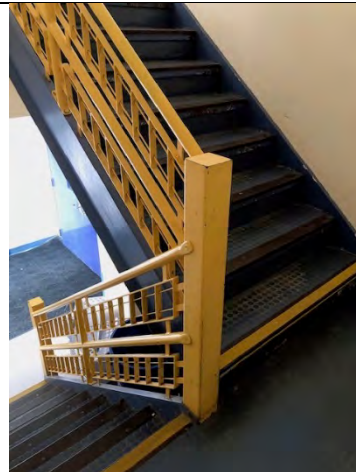

Figure A78: Stair Handrail – Life Safety Compliance Issues (EM)



Figure A79: Stair Handrail – Life Safety Compliance Issues (EM)

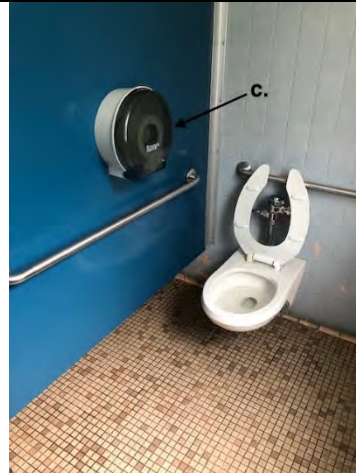

Figure A80: Non-ADA Compliant Toilet Accessories (EM)



Figure A81: Classroom Door without Closer – Life Safety (EM)



Figure A82: Classroom Door Rating Labeling (EM)



Figure A83: Stair Handrail – Life Safety Compliance Issues (EM)

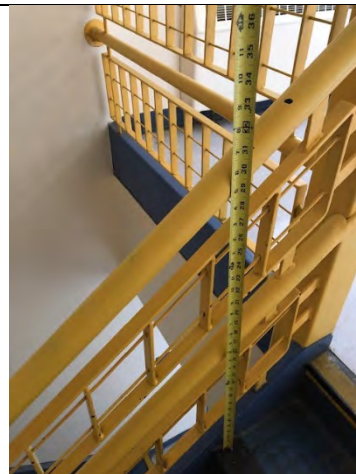

Figure A84: Stair Handrail – Life Safety Compliance Issues (EM)



Figure A85: Non-ADA Compliant Wall Cubbies (EM)



Figure A86: Courtyard without Compliant Egress, Conditions Issues (EM)



Figure A87: Door #1 (EM)



Figure A88: Door #4 (EM)



Figure A89: Door #8 (EM)



Figure A90: Door #9 (EM)



Figure A91: Door #12 (EM)



Figure A92: Door #13 (EM)



Figure A93: Door #14 (EM)



Figure A94: Door #15 (EM)



Figure A95: Door #16 (EM)



Figure A96: Door #17 (EM)



Figure A97: Door #18 (EM)



Figure A98: Door #19 (EM)



Figure A99: Door #20 (EM)



Figure A100: Door #21 (EM)



Figure A101: Door #22 (EM)



Figure A102: Door #23 (EM)



Figure A103: Door #24 (EM)



Figure A104: Door #25 (EM)



Figure A105: Door #26 (EM)



Figure A106: Door #27 (EM)



Figure A107: Door #28 (EM)



Figure A108: Door #29 (EM)



Figure A109: Doors #9 and #10 (EM)



Figure A110: Un-numbered doors at Storage/Boiler Room (EM)

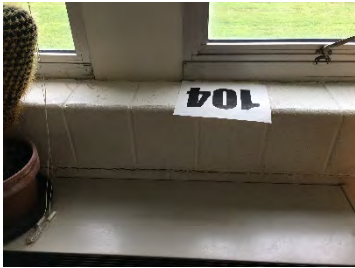

Figure A111: CMU Crack at Window Sill (H)



Figure A112: CMU Crack at Window Sill (H)



Figure A113: Interior Finish Issues at Precast Wall System (H)

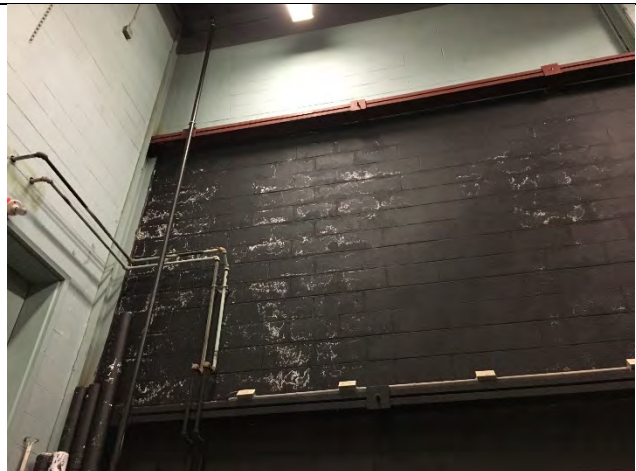

Figure A114: Efflorescence Stains on Interior wall (H)



Figure A115: Precast Window System Sill (H)



Figure A116: Precast Window System (H)



Figure A117: Moisture Issues at Precast Window System (H)



Figure A118: Moisture Issues at Precast Window System (H)



Figure A119: Moisture Issues at Precast Window System (H)



Figure A120: Moisture Issues at Precast Window System (H)

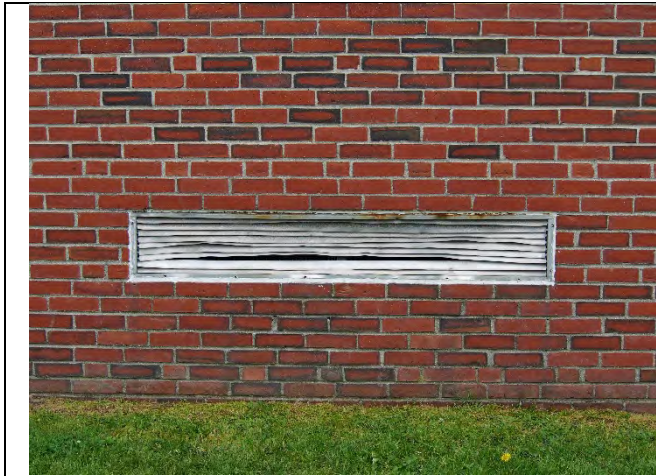

Figure A121: Abandoned and Damaged Wall Louver (H)



Figure A122: Rust Stains at Precast Window System (H)



Figure A123: Precast Window System with Abandoned and Damaged Wall Louver (H)

Not used

Not used

Not used



Figure H1: Metal Lab Air Compressor (H)

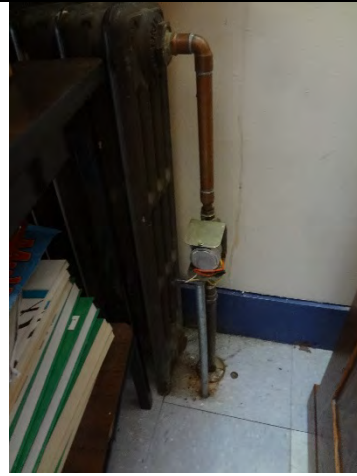

Figure H2: Radiator Control Valves (EM)



Figure H3: Fintube Radiator Covers (EM)



Figure H4: Fintube Radiator Covers (H)



Figure H5: Clean & Repair Cabinet Unit Heaters (M)



Figure H6: Clean & Repair Cabinet Unit Heaters (M)



Figure H7: Clean and Support Fan (M)



Figure H8: Convector Control Wiring (H)



Figure H9: Broken Temperature Sensor (H)



Figure H10: Clean Cabinet Unit Heater Interior (H)



Figure H11: Sagging Return Grilles (H)



Figure H12: Screw Down Roof Equipment (EM)



Figure P1: Hand-held Shower Heads (M)



Figure P2: Plugged Drain Gate (M)



Figure P3: Damaged Drain Gate (M)



Figure P4: Plugged Shower Drains (M)

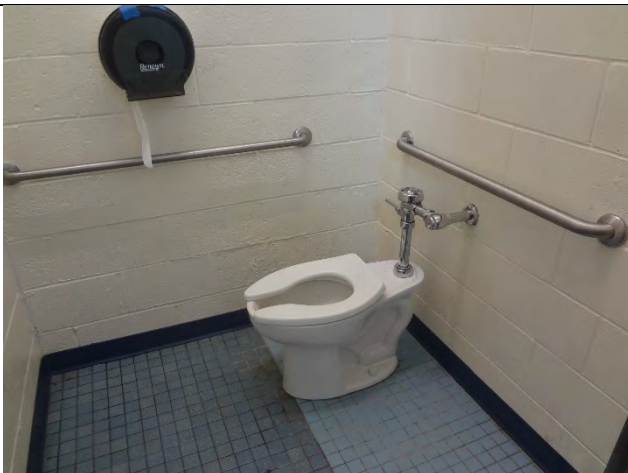

Figure P5: Flush Valve ADA Side (M)



Figure P6: Clean out irrigation boxes (M)



Figure P7: Water Meter bypass seal (H)



Figure P8: Plugged Drain Grate (H)

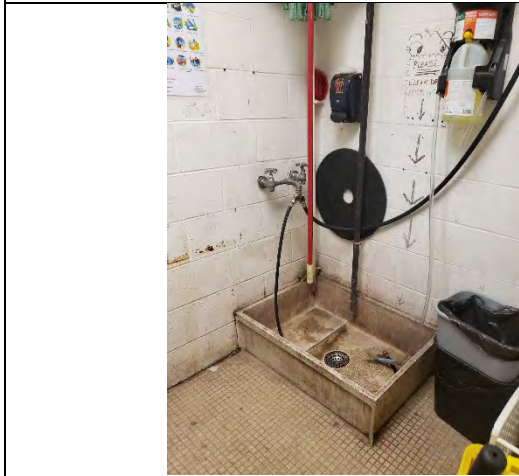

Figure P9: Janitors Sink Faucet (H)



Figure P10: Hose Bibb no VB (H)

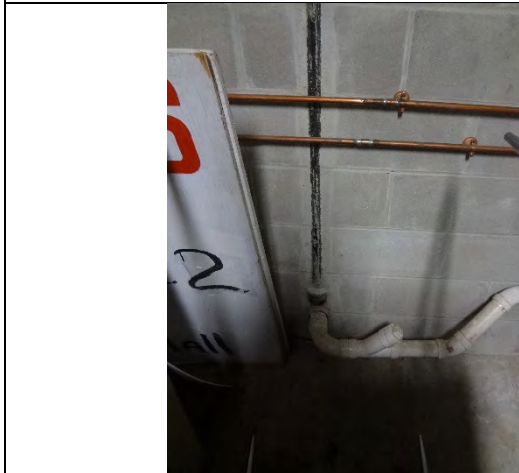

Figure P11: Bare CW-HW Piping (H)



Figure P12: Abandoned Sink Piping (H)

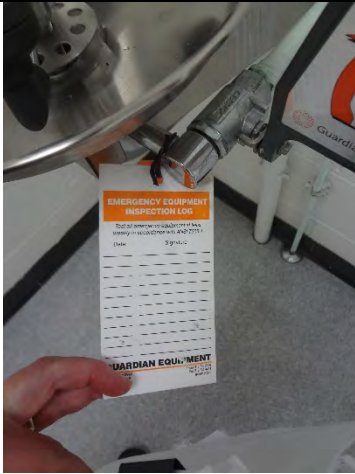

Figure P13: Emergency Fixture Tag unlabeled (EM)



Figure P14: Pitted Faucet (EM)

Not used

Not used

Not used

Not used

APPENDIX C – QUESTIONNAIRE RESULTS

**POND COVE AND MIDDLE SCHOOL
STAKEHOLDER MEETING NOTES**

Band Room:

- Labor intensive to setup stage extenders in cafeteria/auditorium
- Stage extenders need to be removed and re-setup again each day for school lunches (stage is too small)
- Band room is 36'x20' – long and narrow
- Room is not large enough to leave instruments, cases, and equipment on floor
- Can only invite one parent to attend for student performances due to lack of seating.
- Would be more efficient to have bandroom adjacent to nearby music rooms and auditorium
- 200 kids in chorus (not all can meet at once)
- Room is very hot during the summer, and very cold during the winter. Heating unit is left to run overnight to keep room warm for following day – can not run heater during classes as the sound is too loud to hear and drowns out instruments.

Front Entrance:

- Significant concern with regard to security and access to school.
- Visitors to Elementary and Middle School walk by gymnasium and cafeteria before main office, security concern for students.
- Need improved security cameras

Library:

- Would like flexible dedicated space for part time teachers – as new programs come in, storage goes away
- Relocate existing ceiling projector – near skylight which washes out image.
- Concern for mice and ants in classrooms and hallways

Cafeteria:

- 5th graders start sitting for lunch at 10:45AM
- 20 minutes for lunch on average
- Some students who wait in line have even less time to consume food before having to leave for next class
- Very loud acoustically, overcrowded

General:

- Parking spaces during 4th grade graduation (and all graduations) are sparse and causes traffic issues with parents coming and going.
- Site is not handicap accessible:
 - No sidewalks
 - Parents and elderly have issues with site grading
- Wheelchair bound student has to wait at top of stairs for fire department – very difficult to evacuate during a fire.
- Lack of ventilation and windows in Nurses' office – no ventilation means more germs.
 - Students have to help teachers open old windows – too large and too heavy
- Would like to see a K-5 school, currently K-4. Concern over mixing 5th grade students with older 8th grader students.
- Air quality a concern – no air circulation in interior classrooms.
- Lighting – some classrooms are interior classrooms with no natural light. Would like a skylight option for natural light.
- No small spaces for testing. Some students have special requirements for testing that are difficult to accommodate due to lack of proper testing space.
- Toilets in kindergarten wing classrooms – no sinks in the bathroom, have to wash hands in classroom sink (germ concern).
- No central location or gathering space for students.
- There are a number of classrooms without sinks in the 5th and 6th grade classroom areas – want water/sinks in all classrooms.
- Need a 100-150 max occupancy presentation space/lecturehall/classroom that can be shared/signed out by other teachers and students.
- Need for an anxiety/meditative space/quiet space for certain individuals.
- All fluorescent light fixtures should be removed and exchanged for dimmable LED fixtures.
- Want versatile breakout spaces for small student groups to work independently.
- Wish to do something in the basement of the building.

**HIGH SCHOOL STAKEHOLDER MEETING
NOTES**

Library:

- Despite having some air circulation, library remains too warm/hot.
- Would like to relocate projector away from window – too much glare to use during the day.
- Not a lot of space to store large pieces of equipment – currently maxed out for storage.
- Physical access to library is hard to secure – long hallways with (5) doors that are required to be locked down during an evacuation.
- With multiple groups in the library, it's hard to remain quiet in one area while it's being noisy in another.
- Would be nice to have a dedicated space for storing equipment and lockable.

Security:

- Doors are propped open to avoid walking all the way around the school to the main entrance.
- Similar security concerns as Pond Cove/Middle School.

Ventilation:

- Air exchangers are loud and noisy
- Lack of air circulation within interior offices that do not have windows or natural light
- Generally little to no airflow throughout building – areas are either too hot or too cold.

General:

- Request for gender neutral bathrooms.
- Want anti-ligature for private bathrooms that are accessible by students.
- ADA accessibility for front door challenging for anything on crutches, let alone a wheelchair.
- Request for a centrally located nurse office.
- Acoustics in film/TV room are poor – noise carries through walls to adjacent classrooms.
- Need a lactation room for teachers who are nursing (with a sink, and power outlet).

- One science room has had to shut off water due to leakage from 3rd floor to 1st floor.
- Labs haven't changed since 1960's when school was built – sinks are unusable and too small.
- Science labs are built for smaller class sizes 15-18. Once science class has 24 students.
- Teacher is unable to open windows without help from stronger students.
- Need a large, flexible conference room for meetings with college representatives, teacher meetings, small student groups, etc.
- Would like a "Wellness Suite" that is welcoming to all students, and provide a level of privacy when entering the space.
- There is a desire for an auditorium that can support the entire student population for large assemblies and schoolwide announcements. No Cape Schools has an auditorium that can support their entire population.
- Desire for additional storage, across the board for all faculty, staff, and athletics.

APPENDIX D – COST ANALYSIS



CAPE ELIZABETH SCHOOLS - COST WORKSHEET

	Budget	Low	High	
SUB TOTAL COST				\$ -
General Conditions	0.0%	5%	10%	\$ -
Construction Overhead & Profit	0.0%	5%	10%	\$ -
Estimating Conditions Contingency	0.0%	5%	10%	\$ -
BASE CONSTRUCTION COST				\$ -
		ESCALATION VALUE		
CONSTRUCTION YEAR (ESCALATION)	2021	0.04		\$ -
TOTAL CONSTRUCTION COSTS				\$ -
A/E DESIGN FEE	0%			\$ -
CONSTRUCTION ADMIN	0%			\$ -
OTHER SOFT COSTS				
Temporary Relocations				\$ -
FF&E				\$ -
Miscellaneous (Testing, Inspections, Permitting, etc.)				\$ -
OWNER'S CONTINGENCY (IF REQUIRED)	0%			\$ -
GRAND TOTAL				\$ -

User Guide:

A/E Design Fee: This fee is a percentage based on the cost of construction and should be adjusted based on the degree of project complexity. The industry standard for this fee is based on a percentage range from 8% to 14%.

Construction Administration: The Construction Administration value is typically 2%-4% of the construction fee (including contingency).

Construction Year/Escalation: This is a predicting factor based on current construction costs, and what the increase in the total construction cost will be in a subsequent year. Typically this ranges from 1.5%-3% per year, and is based on the estimated time period between the project start date (prior to design) to the estimated mid-point of construction.

Estimating Conditions Contingency: This cost is dependent upon the degree of project complexity. Typically a contingency will be much higher in older buildings where there may be many unknown factors/conditions that are not able to be determined prior to design or construction. Prior to design, the contingency may range from 10%-20%. After design, the contingency will typically range between 5%-15%.

Note: These are industry standard values which apply to a wide range of project types. The escalation ranges provided should be periodically reviewed and updated for their accuracy. This document should be used to estimate a small quantity of projects,

Item Name	School Code	Location	Discipline	Number	Item Code	Priority	Cost	Cost Designation	SRRF Consideration
Gym Flooring Damage & Safety	E	D102	A	1002	E-D102-A-1002	Yellow	\$50,290	\$\$\$	No
Media Center Improvements	E	105	A	1005	E-105-A-1005	Green	\$2,150	\$	No
Wall Repair: Stress Cracks	E	ALL	A	1006	E-ALL-A-1006	Green	\$285	\$	No
Finishes: Wear and Tear	E	D	A	1008	E-D-A-1008	Green	\$30,000	\$\$	No
Water Damage at Window Frame	E	D104	A	1009	E-D104-A-1009	Green	\$1,000	\$	No
Classrooms: General Appearance	EM	ALL	A	3000	EM-ALL-A-3000	Green	\$145,020	\$\$\$\$	No
General Flooring Repair and Upgrades	EM	ALL	A	3002	EM-ALL-A-3002	Green	\$577,224	\$\$\$\$	No
Door Compliance Issues	EM	ALL	A	3003	EM-ALL-A-3003	Red	\$1,090	\$	No
Renovated Auditorium and Support Spaces	EM	D	A	3004	EM-D-A-3004	Green	\$911,460	\$\$\$\$	No
New Cafeteria and Kitchen	EM	NEW	A	3005	EM-NEW-A-3005	Red	\$4,815,500	\$\$\$\$	No
General ADA Compliance: Restrooms	EM	ALL	A	3006	EM-ALL-A-3006	Green	\$2,466	\$	No
General ADA Compliance: Classrooms	EM	ALL	A	3007	EM-ALL-A-3007	Green	\$914	\$	No
General ADA Compliance: Corridors	EM	ALL	A	3008	EM-ALL-A-3008	Green	\$11,261	\$\$	No
Ligature Resistant Restroom Fixtures	H	B246	A	4001	H-B246-A-4001	Red	\$6,762	\$	No
Cafeteria Kitchen Improvements	H	A126	A	4002	H-A126-A-4002	Yellow	\$342,600	\$\$\$\$	No
Energy recovery for units with outdoor air	EM	ALL	M	3029	EM-ALL-M-3029	Green	\$126,000	\$\$\$\$	No
Provide MERV 13 or MERV 11 filters	EM	ALL	M	3030	EM-ALL-M-3030	Green	\$3,000	\$	No
Acoustical Issues: Guidance Suite	H	D	A	4005	H-D-A-4005	Green	\$3,793	\$	No
Occupied Space without Exterior Window	H	ALL	A	4006	H-ALL-A-4006	Green	\$4,736	\$	No
Wall Extension: Acoustical Improvements	H	ALL	A	4007	H-ALL-A-4007	Green	\$27,645	\$\$	No
General Appearance and Finishes	H	ALL	A	4009	H-ALL-A-4009	Green	\$391,377	\$\$\$\$	No
Exposed Piping	H	318	A	4010	H-318-A-4010	Green	\$500	\$	No
Windows: Gasket Failure	H	ALL	A	4011	H-ALL-A-4011	Yellow	\$10,010	\$\$	No
Faculty Support Space: Mother's Room	H	NEW	A	4013	H-NEW-A-4013	Green	\$21,875	\$\$	No
Life Skills Room Improvements	H	202	A	4014	H-202-A-4014	Red	\$6,722	\$	No
Cafeteria: Alternative Seating, Space Inefficiencies	H	A123	A	4015	H-A123-A-4015	Green	\$56,474	\$\$\$	No
Gender Neutral Restrooms	H	ALL	A	4016	H-ALL-A-4016	Red	\$19,597	\$\$	No
Door Compliance Issues	H	ALL	A	4017	H-ALL-A-4017	Red	\$35,574	\$\$	No
General ADA Compliance: Restrooms	H	ALL	A	4018	H-ALL-A-4018	Green	\$6,837	\$	No
Metal Shop Lift	H	C100	A	4019	H-C100-A-4019	Red	\$18,200	\$\$	Yes
Exterior Upgrades at Lower Entry	H	J	A	4020	H-J-A-4020	Green	\$210,000	\$\$\$\$	No
Library and Adjacent Space Configuration	H	A	A	4021	H-A-A-4021	Green	\$22,300	\$\$	No
Programming Improvements and Expansion: Athletic	H	B	A	4022	H-B-A-4022	Green	\$1,520,000	\$\$\$\$	No
Improve School Resource Officer Proximity	H	D	A	4023	H-D-A-4023	Green	\$2,839	\$	No
Social Worker / School Counseling Office	H	D	A	4024	H-D-A-4024	Red	\$140,600	\$\$\$\$	No
New Field House	H	NEW	A	4025	H-NEW-A-4025	Green	\$930,000	\$\$\$\$	No
Alternative Space for Students with Anxiety/Attendance Issues	H	NEW	A	4026	H-NEW-A-4026	Red	\$20,017	\$\$	No
Programming and Improvements: Area D, 2nd Floor	H	D	A	4027	H-D-A-4027	Green	\$391,700	\$\$\$\$	No
Nurse's Space Improvements	H	D	A	4028	H-D-A-4028	Yellow	\$3,189	\$	No
Theater Improvements	H	AB	A	4029	H-AB-A-4029	Green	\$225,940	\$\$\$\$	No
Science Rooms: Improvements	H	320	A	4030	H-320-A-4030	Green	TBD	TBD	No
Programming Improvements and Expansion	H	NEW	A	4031	H-NEW-A-4031	Green	TBD	TBD	No
General Flooring Repair and Upgrades	H	ALL	A	4032	H-ALL-A-4032	Green	\$465,737	\$\$\$\$	No
Kitchen Cooler Upgrades	M	D129	A	2000	M-D129-A-2000	Red	\$28,730	\$\$	No
Elevator Lobby G117	M	G117	A	2001	M-G117-A-2001	Green	\$173	\$	No
NOT USED Window Sealing, Operability Issues	M	ALL	A	2002	M-ALL-A-2002	Yellow	\$1,311,000	\$\$\$\$	No
Courtyard Use and Egress	M	G	A	2003	M-G-A-2003	Green	\$60,189	\$\$\$	No
Music Department Improvements	M	F113	A	2004	M-F113-A-2004	Green	\$1,495	\$	No
1934 Building - Basement Use	M	G	A	2005	M-G-A-2005	Green	\$22,322	\$\$	No
Programming Improvements and Expansion	M	NEW	A	2006	M-NEW-A-2006	Green	TBD	TBD	No
Counseling Space Improvements	M	E	A	2007	M-E-A-2007	Green	\$442,250	\$\$\$\$	No
Maker Space Improvements	M	E137	A	2008	M-E137-A-2008	Green	TBD	TBD	No
Infill: Abandoned Exterior Wall Openings	EM	ALL	BE	3010	EM-ALL-BE-3010	Yellow	\$79	\$	No

Roof Compliance Issues	EM	ALL	BE	3011	EM-ALL-BE-3011	Red	\$20,226	\$\$	No
Skylight Replacement	EM	ROOF	BE	3012	EM-ROOF-BE-3012	Yellow	\$115,259	\$\$\$\$	Yes
Compromised Wall Assembly	H	ALL	BE	4033	H-ALL-BE-4033	Red	\$4,000	\$	No
Roof Compliance Issues	H	ALL	BE	4034	H-ALL-BE-4034	Red	\$20,226	\$\$	No
General Exterior Masonry Repair	EM	ALL	BE	3052	EM-ALL-BE-3052	Yellow	\$96,769	\$\$\$	No
Failing Precast Window Sills	M	G	BE	2010	M-G-BE-2010	Red	\$57,002	\$\$\$	Yes
1934 Building - General Exterior Repair	M	G	BE	2011	M-G-BE-2011	Yellow	\$55	\$	No
Site Issues	EM	EXT	C	3014	EM-EXT-C-3014	Red	\$147,000	\$\$\$\$	No
Provide humidity control for Gym	H	D103	M	4071	H-D103-M-4071	Yellow	\$35,555	\$\$	No
Separate bus exit lane to Ocean House Road	H	EXT	C	4037	H-EXT-C-4037	Green	\$360,000	\$\$\$\$	No
Upgrade phone system to VOIP with Public Address system	EM	ALL	E	3015	EM-ALL-E-3015	Green	\$402	\$	No
Upgrade classroom lighting to LED with Vacancy Sensors	EM	ALL	E	3016	EM-ALL-E-3016	Green	\$60,200	\$\$\$	No
Upgrade corridor lighting to LED with programmable time clock	EM	ALL	E	3017	EM-ALL-E-3017	Green	\$80,200	\$\$\$	No
Provide LED lighting and vacancy sensors for gymnasium	EM	E141	E	3018	EM-E141-E-3018	Green	\$14,000	\$\$	No
Provide upgraded emergency lighting	EM	ALL	E	3019	EM-ALL-E-3019	Green	\$2,005	\$	No
Provide metering on facility to determine total usage	EM	F103	E	3020	EM-F103-E-3020	Green	\$5,000	\$	No
Provide vacancy sensors throughout	EM	ALL	E	3021	EM-ALL-E-3021	Green	\$45,000	\$\$	No
Provide upgraded DMX compatible lighting for stage with digital control	EM	ALL	E	3022	EM-ALL-E-3022	Green	\$20,000	\$\$	No
Provide dedicated circuits and charging stations	EM	ALL	E	3023	EM-ALL-E-3023	Green	\$50,000	\$\$	No
Provide updated Smart boards and technology to replace ceiling mounted projectors	EM	ALL	E	3024	EM-ALL-E-3024	Green	\$40,200	\$\$	No
Provide AI phone video/remote door controls and communication	EM	ALL	E	3025	EM-ALL-E-3025	Green	\$5,000	\$	No
Provide additional camera and exterior lighting coverage	H	EXT	E	4038	H-EXT-E-4038	Green	\$10,000	\$	No
Upgrade phone system to VOIP with Public Address system	H	ALL	E	4039	H-ALL-E-4039	Green	\$30,000	\$\$	No
Replace non metallic wiring above suspended ceiling with MC	H	ALL	E	4040	H-ALL-E-4040	Yellow	\$5,000	\$	No
Provide upgraded emergency lighting	H	ALL	E	4041	H-ALL-E-4041	Green	\$10,000	\$	No
Provide metering on facility to determine total usage	H	ALL	E	4042	H-ALL-E-4042	Green	\$5,000	\$	No
Upgrade T12 fixtures with LED	H	B211	E	4043	H-B211-E-4043	Yellow	\$500	\$	No
Provide additional circuits to classrooms for circuits	H	ALL	E	4044	H-ALL-E-4044	Green	\$50,000	\$\$	No
Provide additional 120 volt panels throughout for spare and circuits	H	ALL	E	4045	H-ALL-E-4045	Green	\$15,000	\$\$	No
Provide programmable time clock for corridor lighting	H	ALL	E	4046	H-ALL-E-4046	Green	\$1,500	\$	No
Provide AI phone video/remote door controls and communication	H	ALL	E	4047	H-ALL-E-4047	Green	\$5,000	\$	No
Replace Fluorescent lighting with LED with dimming	H	ALL	E	4048	H-ALL-E-4048	Green	\$5,000	\$	No
Provide automated lighting to raise/lower auditorium lights	H	AUD	E	4049	H-AUD-E-4049	Green	\$15,000	\$\$	No
General Intercom Reliability / Intelligibility	H	ALL	SC	4050	H-ALL-SC-4050	Red	\$22,000	\$\$	Yes
Provide conduit supports in mechanical room	M	E163	E	2014	M-E163-E-2014	Yellow	\$500	\$	No
Repair leaking sprinkler system riser	E	C102	FP	1011	E-C102-FP-1011	Yellow	\$10,000	\$	No
Combine Fire Alarm Occupant Notification Systems	H	ALL	FP	4051	H-ALL-FP-4051	Yellow	\$125,000	\$\$\$\$	No
Install additional sprinklers above the ceiling	M	D117	FP	2015	M-D117-FP-2015	Yellow	\$25,000	\$\$	No
Relocate kitchen hood manual pull	M	D131	FP	2016	M-D131-FP-2016	Yellow	\$5,000	\$	No
Provide automatic sprinkler system protection per NFPA 13.	H	C	FP	4117	H-C-FP-4117	Yellow	\$150,000	\$\$\$\$	No
Fire Alarm Equipment Location Smoke Detection	H	D115	FP	4118	H-D115-FP-4118	Yellow	\$5,000	\$	No
Fire Rating at Boiler Room	E	E121	LS	1010	E-E121-LS-1010	Red	\$751	\$	No

Stair C102 and C209 Life Safety Updates	E	C	LS	1012	E-C-LS-1012	Red	\$13,207	\$\$	No
Unrated Ceiling at Janitor's Closet	E	C117	LS	1013	E-C117-LS-1013	Red	\$3,104	\$	No
Exterior Doors	EM	ALL	LS	3026	EM-ALL-LS-3026	Yellow	\$22,666	\$\$	No
Conduit Penetrations to Corridor	EM	ALL	LS	3001	EM-ALL-LS-3001	Red	\$32,000	\$\$	No
Life Safety: Room Signage	EM	ALL	LS	3027	EM-ALL-LS-3027	Red	\$26,400	\$\$	No
Life Safety: Room Signage	H	ALL	LS	4052	H-ALL-LS-4052	Red	\$26,400	\$\$	No
Wall Extension: Life Safety	H	ALL	LS	4053	H-ALL-LS-4053	Red	\$31,375	\$\$	No
Conduit Penetrations at Corridor	H	ALL	LS	4012	H-ALL-LS-4012	Red	\$19,300	\$\$	No
Paint Spray Booth	H	C102	LS	4054	H-C102-LS-4054	Red	\$17,000	\$\$	Yes
Exit Width Diminished	M	G128	LS	2017	M-G128-LS-2017	Red	\$4,327	\$	No
Special Ed Room: ADA and Life Safety Upgrades	M	E109	LS	2019	M-E109-LS-2019	Red	\$14,504	\$\$	No
Life Safety & Egress Compliance	EM	G	LS	3053	EM-G-LS-3053	Red	\$26,700	\$\$	No
Replace and relocate Kindergarten roof hood	E	ROOF	M	1015	E-ROOF-M-1015	Yellow	\$4,680	\$	Yes
Relocate kiln closer to art room	E	B106	M	1019	E-B106-M-1019	Yellow	\$2,500	\$	No
Provide improved HVAC control for band room	E	A127	M	1020	E-A127-M-1020	Yellow	\$295	\$	No
Relocate gooseneck on kindergarten roof	E	C	M	1021	E-C-M-1021	Yellow	\$980	\$	Yes
Replace EF-7 roof jack with hood	E	ROOF	M	1022	E-ROOF-M-1022	Yellow	\$800	\$	No
Replace HRU-2 in A-wing	E	ROOF	M	1023	E-ROOF-M-1023	Yellow	\$28,625	\$\$	No
Relocate Kindergarten exhaust fans	E	ROOF	M	1014	E-ROOF-M-1014	Yellow	\$11,640	\$\$	Yes
Provide burglar bars at low louvers	EM	ALL	SC	3028	EM-ALL-SC-3028	Yellow	\$6,000	\$	No
Provide exhaust at copier/printers	EM	ALL	M	3031	EM-ALL-M-3031	Yellow	\$6,255	\$	Yes
Provide cooling for summer programs	EM	ALL	M	3032	EM-ALL-M-3032	Green	\$95,000	\$\$\$	No
Provide equipment numbering and nameplates	EM	ALL	M	3033	EM-ALL-M-3033	Yellow	\$4,250	\$	No
Reseal existing ductwork to remain	EM	ALL	M	3034	EM-ALL-M-3034	Yellow	\$29,000	\$\$	No
Increase Ventilation for Improved IAQ	EM	ALL	M	3035	EM-ALL-M-3035	Green	\$15,000	\$\$	Yes
Provide full commissioning of HVAC systems	EM	ALL	M	3036	EM-ALL-M-3036	Yellow	\$75,000	\$\$\$	No
Provide room sensors with occupant adjustment	EM	ALL	M	3037	EM-ALL-M-3037	Green	\$56,000	\$\$\$	No
Provide Corridor Ventilation	EM	ALL	M	3038	EM-ALL-M-3038	Yellow	\$64,250	\$\$\$	Yes
Provide Ventilation to Quiet Rooms	EM	A110	M	3039	EM-A110-M-3039	Yellow	\$2,700	\$	Yes
Clean existing ductwork to remain	EM	ALL	M	3040	EM-ALL-M-3040	Yellow	\$6,600	\$	Yes
Replace damaged diffusers and grilles	EM	ALL	M	3041	EM-ALL-M-3041	Yellow	\$6,000	\$	No
Remove abandoned boiler room intake	EM	BSMT	M	3042	EM-BSMT-M-3042	Yellow	\$1,600	\$	No
Replace Cast Iron Radiators with Cooler Types	EM	ALL	M	3043	EM-ALL-M-3043	Yellow	\$19,440	\$\$	Yes
Protect exposed piping insulation	EM	ALL	M	3044	EM-ALL-M-3044	Green	\$15,360	\$\$	No
Kitchen hood switch location	EM	D131	M	3045	EM-D131-M-3045	Yellow	\$900	\$	Yes
Burglar Bars	H	ALL	SC	4055	H-ALL-SC-4055	Yellow	\$6,000	\$	No
Energy recovery for units with outdoor air	H	ALL	M	4056	H-ALL-M-4056	Green	\$126,000	\$\$\$\$	No
Provide MERV 13 or MERV 11 filters	H	ALL	M	4057	H-ALL-M-4057	Yellow	\$3,000	\$	Yes
Replace Unit Ventilators	H	ALL	M	4058	H-ALL-M-4058	Yellow	\$306,750	\$\$\$\$	Yes
Provide equipment numbering and nameplates	H	ALL	M	4059	H-ALL-M-4059	Yellow	\$4,250	\$	No
Provide exhaust at copier/printers	H	ALL	M	4060	H-ALL-M-4060	Yellow	\$6,255	\$	Yes
Provide cooling for summer programs	H	ALL	M	4061	H-ALL-M-4061	Green	\$95,000	\$\$\$	No
Increase Ventilation for Improved IAQ	H	ALL	M	4062	H-ALL-M-4062	Green	\$62,160	\$\$\$	Yes
Provide full commissioning of HVAC systems	H	ALL	M	4063	H-ALL-M-4063	Yellow	\$67,500	\$\$\$	No
Provide increased library cooling	H	220	M	4064	H-220-M-4064	Yellow	\$10,960	\$\$	No
Provide cooling to life skills room	H	202	M	4065	H-202-M-4065	Yellow	\$5,480	\$	No
Provide additional heat to front office staff	H	D	M	4066	H-D-M-4066	Yellow	\$17,760	\$\$	No
Provide HVAC to theater costume storage	H	C131	M	4067	H-C131-M-4067	Yellow	\$1,850	\$	Yes
Provide increased ventilation	H	A208	M	4068	H-A208-M-4068	Green	\$1,850	\$	Yes
Provide room sensors with occupant adjustment	H	ALL	M	4069	H-ALL-M-4069	Green	\$47,200	\$\$	No
Separate HVAC systems for Pool lockers	H	D114	M	4070	H-D114-M-4070	Yellow	\$78,625	\$\$\$	Yes
Provide Corridor Ventilation	H	ALL	M	4072	H-ALL-M-4072	Yellow	\$64,250	\$\$\$	Yes
Mech B216 Equipment Replacement - HVAC	H	B216	M	4073	H-B216-M-4073	Yellow	\$86,495	\$\$\$	No
Increase HVAC to robotics lab	H	B306	M	4074	H-B306-M-4074	Yellow	\$35,000	\$\$	No
Additional Art Room heat and ventilation	H	A110	M	4075	H-A110-M-4075	Yellow	\$7,880	\$	Yes

Replace boiler room pumps	H	C115	M	4076	H-C115-M-4076	Yellow	\$15,000	\$\$	No
Provide metal dust collection system	H	C100	M	4077	H-C100-M-4077	Red	\$41,500	\$\$	Yes
Storage of compressed gas tanks	H	C100	M	4078	H-C100-M-4078	Red	\$32,300	\$\$	No
Provide ventilation for welding	H	C100	M	4079	H-C100-M-4079	Red	\$48,500	\$\$	Yes
Provide plotter exhaust in tech CAD room	H	C105	M	4080	H-C105-M-4080	Yellow	\$2,205	\$	Yes
Provide copier/printer exhaust in teacher room	H	B215	M	4081	H-B215-M-4081	Yellow	\$2,205	\$	Yes
Provide HVAC for OT/PT room	H	B217	M	4082	H-B217-M-4082	Yellow	\$19,250	\$\$	Yes
Rebalance and repair AHU above stage	H	C132	M	4083	H-C132-M-4083	Yellow	\$1,200	\$	No
Clean existing ductwork to remain	H	ALL	M	4084	H-ALL-M-4084	Yellow	\$6,600	\$	Yes
Replace damaged diffusers and grilles	H	ALL	M	4085	H-ALL-M-4085	Yellow	\$6,000	\$	No
Fan Blades Exposed to Outdoors	H	B216	M	4086	H-B216-M-4086	Red	\$850	\$	No
Louver Security and Damage	H	ALL	M	4087	H-ALL-M-4087	Yellow	\$11,500	\$\$	No
Unit Ventilator Louver Damage	H	ALL	M	4088	H-ALL-M-4088	Yellow	\$3,000	\$	No
Intake and Exhaust Louver Separation	H	B216	M	4089	H-B216-M-4089	Yellow	\$3,050	\$	No
Teacher Lounge remove abandoned exhaust	H	B212	M	4090	H-B212-M-4090	Yellow	\$2,025	\$	No
Mech Room B216 - Replace valves and fittings	H	B216	M	4091	H-B216-M-4091	Yellow	\$1,375	\$	No
Mech Room B216 - Remove pneumatic controls	H	B216	M	4092	H-B216-M-4092	Yellow	\$750	\$	No
Nurse's Toilet B323 - Move fintube for ADA	H	B323	M	4093	H-B323-M-4093	Yellow	\$1,800	\$	No
Vestibule B319 - Replace cabinet unit heater	H	B319	M	4094	H-B319-M-4094	Yellow	\$1,146	\$	No
Nurse's Assist B322 - Convector pipe seal and firestop	H	B322	M	4095	H-B322-M-4095	Yellow	\$3,350	\$	Yes
Replace wall relief grille with larger	H	309	M	4096	H-309-M-4096	Yellow	\$725	\$	No
Relocate CUH wall temperature sensor	H	A111	M	4097	H-A111-M-4097	Yellow	\$250	\$	No
Kitchen hood switch and appliance coverage	H	A126	M	4098	H-A126-M-4098	Yellow	\$19,650	\$\$	Yes
Replace Roof Cap	M	ROOF	M	2021	M-ROOF-M-2021	Yellow	\$800	\$	No
Condensing Unit Repairs	M	ROOF	M	2022	M-ROOF-M-2022	Yellow	\$4,400	\$	No
Replace AHU-5, 6, 7	M	E163	M	2023	M-E163-M-2023	Yellow	\$91,500	\$\$\$	No
Re-insulate in mech and boiler rooms	M	E163	M	2024	M-E163-M-2024	Yellow	\$10,408	\$\$	No
Repair-replace valves in mech room	M	E163	M	2025	M-E163-M-2025	Yellow	\$1,100	\$	No
Support for pipes at pumps P-3 and P-4	M	E163	M	2026	M-E163-M-2026	Yellow	\$1,600	\$	No
Relocate AHU-4 to serviceable location	M	D173	M	2027	M-D173-M-2027	Yellow	\$5,000	\$	No
Repair elevator machine room	M	C118	M	2028	M-C118-M-2028	Red	\$7,950	\$	Yes
Provide outdoor air to nurse's office	M	E145	M	2029	M-E145-M-2029	Yellow	\$2,750	\$	Yes
Improve exhaust in kiln room	M	E164	M	2030	M-E164-M-2030	Yellow	\$2,105	\$	Yes
Replace HRU-8 and 9	M	ROOF	M	2032	M-ROOF-M-2032	Yellow	\$83,500	\$\$\$	No
Provide new heating in Band Room	M	F113	M	2033	M-F113-M-2033	Yellow	\$2,027	\$	No
Provide improved Auditorium HVAC	M	D154	M	2035	M-D154-M-2035	Yellow	\$18,000	\$\$	Yes
Improve HVAC for 8th grade wing	M	G	M	2038	M-G-M-2038	Yellow	\$22,500	\$\$	No
Science classroom exhaust hoods	M	ALL	M	2039	M-ALL-M-2039	Yellow	\$73,800	\$\$\$	Yes
Improved HVAC for special education wing	M	G	M	2040	M-G-M-2040	Yellow	\$11,500	\$\$	No
Increased HVAC control to foreign language	M	E148	M	2041	M-E148-M-2041	Yellow	\$3,500	\$	No
Increase Media Center cooling	M	G141	M	2042	M-G141-M-2042	Yellow	\$10,960	\$\$	No
Replace cabinet unit heaters at entry	M	D116	M	2043	M-D116-M-2043	Yellow	\$2,292	\$	No
Provide new bubblers on classroom sinks	E	ALL	P	1024	E-ALL-P-1024	Yellow	\$29,250	\$\$	No
Move plumbing vents from air intakes	EM	ALL	P	3046	EM-ALL-P-3046	Yellow	\$23,500	\$\$	Yes
Provide emergency plumbing fixtures	EM	ALL	P	3047	EM-ALL-P-3047	Red	\$33,600	\$\$	Yes
Provide automatic-sensor control at fixtures	EM	ALL	P	3048	EM-ALL-P-3048	Green	\$99,555	\$\$\$	No
Domestic hot water pressure and response time	EM	G	P	3049	EM-G-P-3049	Yellow	\$4,000	\$	No
Provide dual height drinking fountains	EM	ALL	P	3050	EM-ALL-P-3050	Yellow	\$93,500	\$\$\$	Yes
Provide automatic-sensor control at fixtures	H	ALL	P	4100	H-ALL-P-4100	Green	\$60,450	\$\$\$	No
Provide emergency plumbing fixtures	H	ALL	P	4099	H-ALL-P-4099	Red	\$22,400	\$\$	Yes
Replace sanitary piping in ceiling cavities	H	A313	P	4101	H-A313-P-4101	Yellow	\$30,400	\$\$	Yes
Replace domestic water to science classrooms	H	ALL	P	4102	H-ALL-P-4102	Yellow	\$4,185	\$	Yes
Provide Dual Height Drinking Fountains	H	ALL	P	4103	H-ALL-P-4103	Yellow	\$94,000	\$\$\$	No
Provide clay/sediment traps at art sinks	H	C106	P	4104	H-C106-P-4104	Yellow	\$3,200	\$	Yes
Provide chemical neutralizers for photo sinks	H	C101	P	4105	H-C101-P-4105	Yellow	\$10,650	\$\$	Yes

Protect cold water entrance piping	H	B216	P	4106	H-B216-P-4106	Yellow	\$2,350	\$	No
Protect Mech Rm. from water entrance flooding	H	B216	P	4107	H-B216-P-4107	Yellow	\$5,550	\$	No
Replace piping insulation in Mech. B216	H	B216	P	4108	H-B216-P-4108	Yellow	\$9,797	\$	No
Emergency eyewash piping in Mech Rm B216	H	B216	P	4109	H-B216-P-4109	Yellow	\$1,450	\$	Yes
COT Room B325 - Eyewash issues	H	B325	P	4110	H-B325-P-4110	Yellow	\$1,300	\$	Yes
Plumbing venting and trap primer	H	A126	P	4111	H-A126-P-4111	Yellow	\$3,750	\$	Yes
Kitchen sinks for proper sanitation	H	A126	P	4112	H-A126-P-4112	Yellow	\$6,500	\$	Yes
Repairs at water heaters	M	E163	P	2044	M-E163-P-2044	Red	\$4,100	\$	No
Replace corroded kitchen gas and water piping	M	D131	P	2045	M-D131-P-2045	Yellow	\$4,478	\$	No
Replace art room sinks	M	E160	P	2046	M-E160-P-2046	Yellow	\$9,000	\$	Yes
Provide sufficient hot water to showers	M	E	P	2047	M-E-P-2047	Yellow	\$1,650	\$	No
Faucets and filters for special education	M	G	P	2048	M-G-P-2048	Yellow	\$2,200	\$	No
Provide adequate kitchen sinks	M	D131	P	2049	M-D131-P-2049	Yellow	\$10,400	\$\$	Yes
Grout CMU Crack	E	E	S	1025	E-E-S-1025	Green	\$100	\$	No
Roof Reinforcing	H	A	S	4114	H-A-S-4114	Red	\$28,416	\$\$	Yes
New Secure Entrance and Support Spaces	EM	NEW	SC	3051	EM-NEW-SC-3051	Red	\$1,890,000	\$\$\$\$	No
Security Protocol Weak Points	H	ALL	SC	4115	H-ALL-SC-4115	Red	\$2,525	\$	No
Security Camera Improvements	H	ALL	SC	4116	H-ALL-SC-4116	Red	\$27,500	\$\$	No
Replace Kindergarten Wing Intake Hood	E	ROOF	M	1026	E-ROOF-M-1026	Yellow	\$980	\$	No
Firestop wall and floor penetrations	EM	ALL	FP	3054	EM-ALL-FP-3054	Yellow	\$36,000	\$\$	No
Firestop wall and floor penetrations	H	ALL	FP	4119	H-ALL-FP-4119	Yellow	\$42,000	\$\$	No
Replace roof drains	EM	ALL	P	3055	EM-ALL-P-3055	Yellow	\$9,375	\$	No
Replace roof drains	H	ALL	P	4120	H-ALL-P-4120	Yellow	\$7,500	\$	No
Replace overhead hot water tank	H	C115	M	4121	H-C115-M-4121	Yellow	\$3,000	\$	No
Secure Covered Storage Below Bleachers	H	NEW	A	4122	H-NEW-A-4122	Green	\$8,300	\$	No

APPENDIX E – PLUMBING CODE REQUIREMENTS

Appendix E - Narrative

The UPC 2015 (Uniform Plumbing Code, as adopted in the Maine Plumbing Code) Chapter 4, Plumbing Fixtures and Fixture Fittings, subchapter 422.0 Minimum Number of Required Fixtures, and the associated Table 422.1 Minimum Plumbing Facilities, list requirements for quantities of several types of plumbing fixtures. The design basis must be the occupancy type and occupant load (people count) as defined in the Building Code (which in Maine is the International Building Code (IBC)). Occupants must be presumed to be 50% female and 50% male for the purposes of this analysis. Where the analysis results in a fractional number, any fraction shall be rounded up to the next whole number. Separate facilities shall be provided for each sex (the Code uses the term “both sexes” but does not define sex or gender).

This Appendix provides tables comparing the Code requirements to existing fixture quantities, and lists as deficiencies the quantities of additional fixtures that would be required to bring the schools up to current Code. Under the Deficient column, deficiencies are positive numbers highlighted in red, and numbers in excess of the Code requirements are listed as negative numbers.

This Appendix considers two occupancy types in Table 422.1: Type A (Assembly) and Type E (Educational). Within Type A there are 5 subtypes, with A-1 having fixed seating such as auditoriums, and A-3 having non-fixed seating such as gymnasiums. The required quantities of fixtures vary significantly between occupancy types. The fixture quantities required by the UPC used in Maine are different and sometimes more stringent than in the IPC (International Plumbing Code) and other codes used in other states.

This Appendix lists fixtures as Gender Neutral where they are available to people of any gender, such as drinking fountains in open corridors, and other fixtures in single-user toilet rooms. Although the Code does not have gender neutrality requirements, Code-required numbers of drinking fountains are listed in this Appendix as Gender Neutral because they must be available to everyone.

This Appendix does not examine the requirements for accessible fixtures for people with disabilities; UPC 2015 subchapter 403.0 Accessible Plumbing Facilities refers to other standards for accessibility requirements. Accessibility of plumbing fixtures is noted in other portions of this report.

This Appendix uses the following abbreviations:

BF	Bottle Filler
DF	Drinking Fountain
Lav	Lavatory (hand washing sink)
UR	Urinal
WC	Water Closet

Elementary School									
Educational Occupancy - Students									
	UPC 2015 Required			Existing			Deficient		
	Female	Male	Gender Neutral	Female	Male	Gender Neutral	Female	Male	Gender Neutral
WC	7	7		15	7	11	-8	0	-11
UR		4			8			-4	
Lav	8	8		8	8	6	0	0	-6
DF			5			2 single w/ bf, 1 dual, 29 classroom bubblers			
Educational Occupancy - Staff									
	UPC 2015 Required			Existing			Deficient		
	Female	Male	Gender Neutral	Female	Male	Gender Neutral	Female	Male	Gender Neutral
WC	1	1					1	1	0
UR								0	
Lav	1	1					1	1	0
DF			1						
Assembly Occupancy - Cafetorium									
	UPC 2015 Required			Existing			Deficient		
	Female	Male	Gender Neutral	Female	Male	Gender Neutral	Female	Male	Gender Neutral
WC	8	3		3	1	1	5	2	-1
UR		3			1			2	
Lav	5	2		2	2	1	3	0	-1
DF			3			1 single w/ bf			
Assembly Occupancy - Gym									
	UPC 2015 Required			Existing			Deficient		
	Female	Male	Gender Neutral	Female	Male	Gender Neutral	Female	Male	Gender Neutral
WC	8	3		3	1	1	5	2	-1
UR		3			1			2	
Lav	5	2		2	2	1	3	0	-1
DF			3			0			3
Assembly Occupancy - Both at once									
	UPC 2015 Required			Existing			Deficient		
	Female	Male	Gender Neutral	Female	Male	Gender Neutral	Female	Male	Gender Neutral
WC	19	8		3	1	1	16	7	-1
UR		8			1			7	
Lav	11	7		2	2	1	9	5	-1
DF			9			0			9

Middle School									
Educational Occupancy - Students									
	UPC 2015 Required			Existing			Deficient		
	Female	Male	Gender Neutral	Female	Male	Gender Neutral	Female	Male	Gender Neutral
WC	6	6		25	17	7	-19	-11	-7
UR		3			5			-2	
Lav	7	7		19	18	7	-12	-11	-7
DF			4			5 single w/ bf, 2 single, at least 10 classroom bubblers			
Educational Occupancy - Staff									
	UPC 2015 Required			Existing			Deficient		
	Female	Male	Gender Neutral	Female	Male	Gender Neutral	Female	Male	Gender Neutral
WC	1	1					1	1	0
UR								0	
Lav	2	2					2	2	0
DF			1						
Assembly Occupancy - Cafetorium									
	UPC 2015 Required			Existing			Deficient		
	Female	Male	Gender Neutral	Female	Male	Gender Neutral	Female	Male	Gender Neutral
WC	8	3		3	1	1	5	2	-1
UR		3			1			2	
Lav	5	2		2	2	1	3	0	-1
DF			3			1 single w/ bf			
Assembly Occupancy - MS Gym									
	UPC 2015 Required			Existing			Deficient		
	Female	Male	Gender Neutral	Female	Male	Gender Neutral	Female	Male	Gender Neutral
WC	10	4		10	8		0	-4	0
UR		4			0			4	
Lav	6	3		8	7		-2	-4	0
DF			4			1 single, 1 single w/ bf			
Assembly Occupancy - Both at once									
	UPC 2015 Required			Existing			Deficient		
	Female	Male	Gender Neutral	Female	Male	Gender Neutral	Female	Male	Gender Neutral
WC	12	4		13	9	1	-1	-5	-1
UR		5			1			4	
Lav	7	5		10	9	1	-3	-4	-1
DF			5			1 single, 1 single w/ bf			

High School									
Educational Occupancy - Students									
	UPC 2015 Required			Existing			Deficient		
	Female	Male	Gender Neutral	Female	Male	Gender Neutral	Female	Male	Gender Neutral
WC	7	7		25	12	6	-18	-5	-6
UR		4			12			-8	
Lav	8	8		15	15	5	-7	-7	-5
DF			4			4 single, 3 single w/ bf, 2 dual			
Educational Occupancy - Staff									
	UPC 2015 Required			Existing			Deficient		
	Female	Male	Gender Neutral	Female	Male	Gender Neutral	Female	Male	Gender Neutral
WC	2	2					2	2	0
UR		1						1	
Lav	2	2					2	2	0
DF			1						
Assembly Occupancy - Auditorium									
	UPC 2015 Required			Existing			Deficient		
	Female	Male	Gender Neutral	Female	Male	Gender Neutral	Female	Male	Gender Neutral
WC	6	3		7	2		-1	1	0
UR		2			6			-4	
Lav	4	2		4	4		0	-2	0
DF			3			1 single w/ bf, 1 dual			
Assembly Occupancy - Gym									
	UPC 2015 Required			Existing			Deficient		
	Female	Male	Gender Neutral	Female	Male	Gender Neutral	Female	Male	Gender Neutral
WC	13	5		6	4	3	7	1	-3
UR		6			3			3	
Lav	7	5		4	4	2	3	1	-2
DF			6			3 single, 1 single w/ bf, 1 dual			
Assembly Occupancy - Both at once									
	UPC 2015 Required			Existing			Deficient		
	Female	Male	Gender Neutral	Female	Male	Gender Neutral	Female	Male	Gender Neutral
WC	19	8		10	5	3	9	3	-3
UR		8			6			2	
Lav	11	7		6	6	2	5	1	-2
DF			9			3 single, 1 single w/ bf, 1 dual			

APPENDIX F – EXISTING DIAGRAMMATIC FLOORPLANS

PROJECT NAME:
**CAPE ELIZABETH
ELEMENTARY
AND MIDDLE**

PROJECT LOCATION

SEAL:

**NOT FOR
CONSTRUCTION**

THIS DRAWING IS THE PROPERTY OF
SCOTT SIMONS ARCHITECTS (SSA) AND
IS NOT TO BE COPIED OR REPRODUCED
IN PART OR WHOLE.
2018 © SCOTT SIMONS ARCHITECTS, LLC

△ REVISIONS

DATE OF ISSUE: DATE OF ISSUE
PROJECT NUMBER: 2017-0110
STATUS: 0% PROGRESS

**AREA G -
BASEMENT PLAN**

A100G

ROOM TAG LEGEND	
ROOM NAME [RM #] AREA SQFT	ROOM TAG PROVIDED BY FACILITIES
ROOM NAME [RM #] AREA SQFT	ROOM TAG BY EXISTING CONDITIONS
ROOM NAME [RM #] AREA SQFT	ROOM TAG ASSIGNED BY SSA

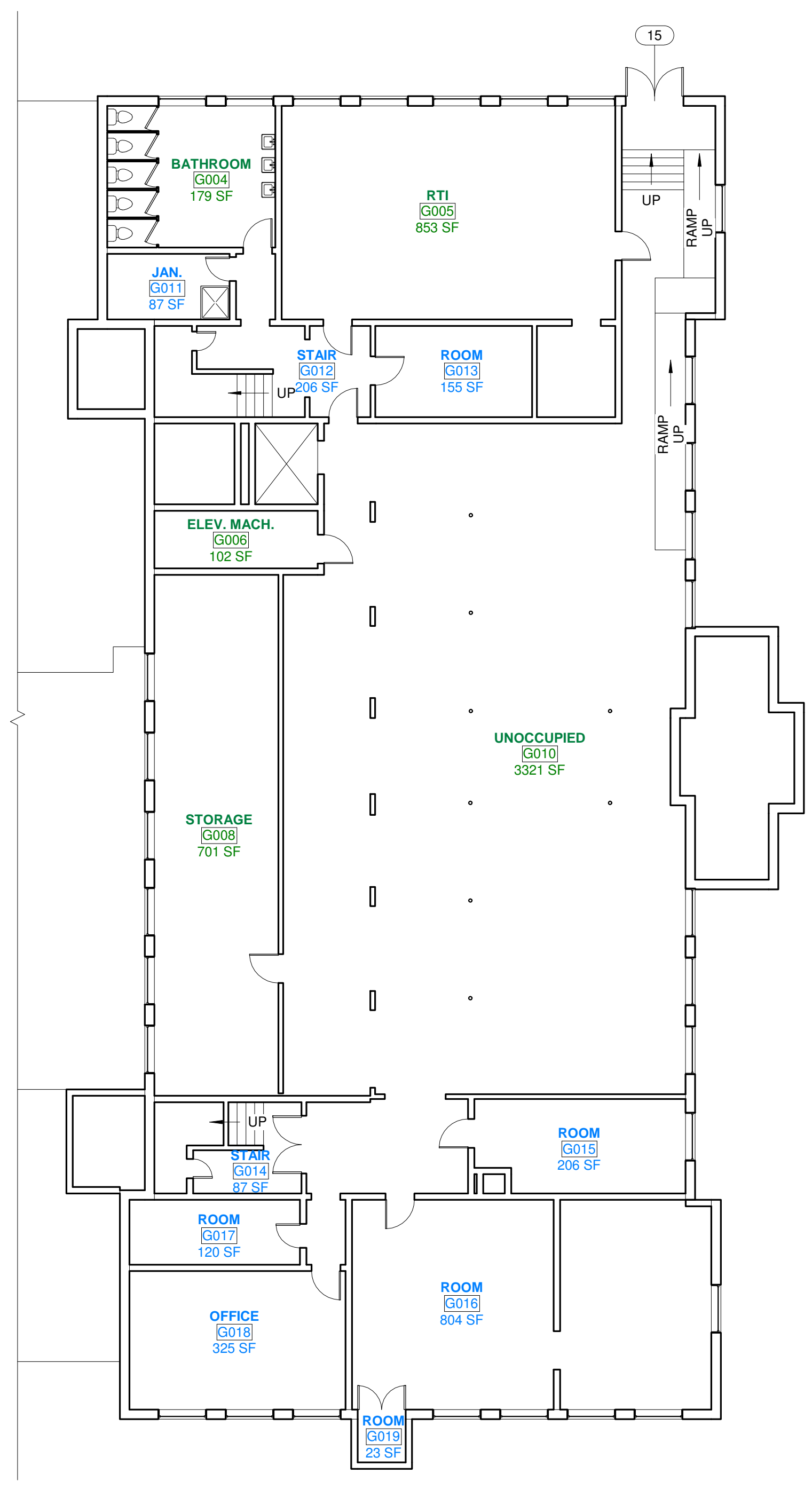
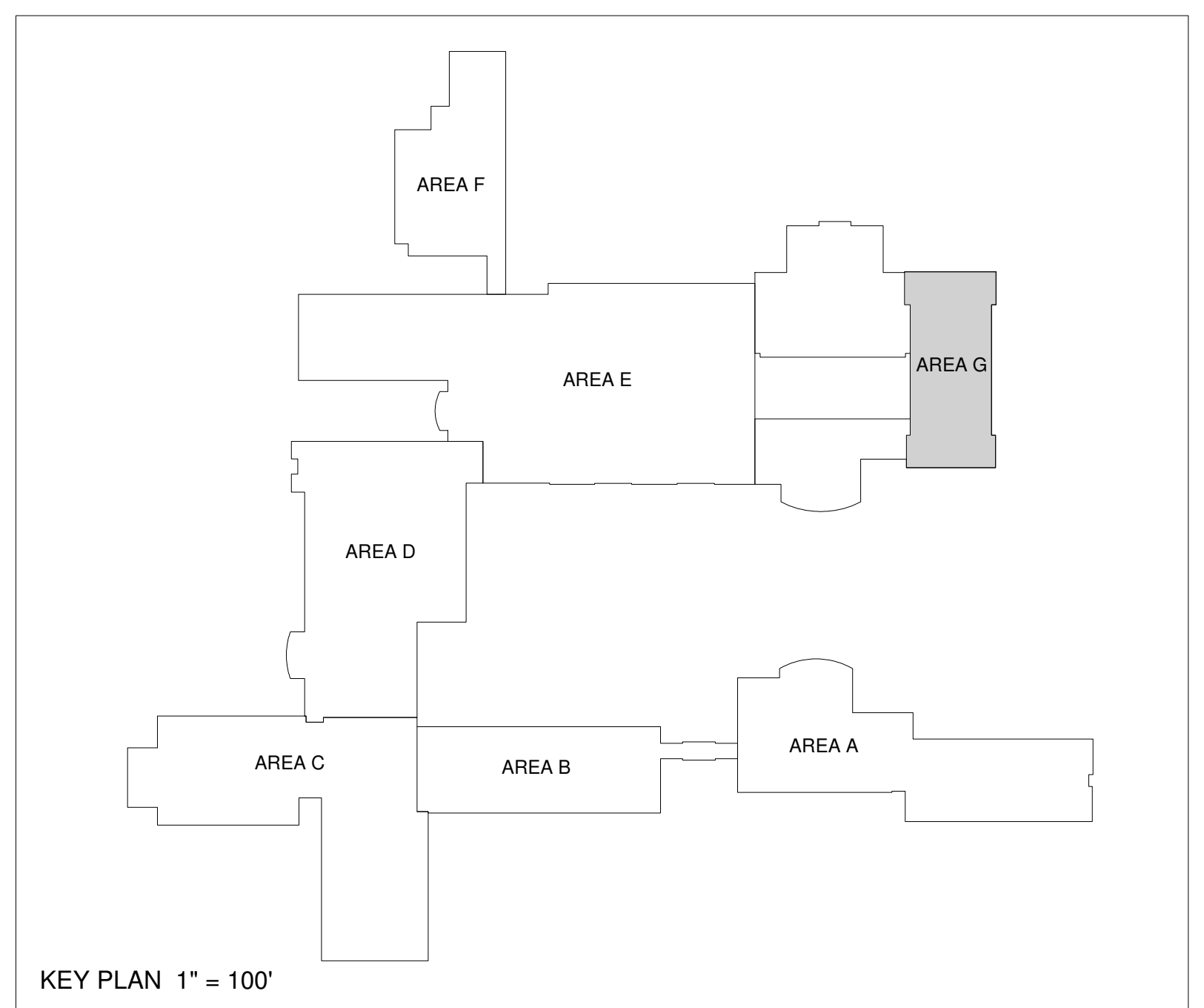

① AREA G BASEMENT
3/32" = 1'-0"

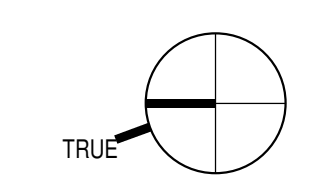



75 York Street
Portland, Maine 04101
simonsarchitects.com
207.772.4656

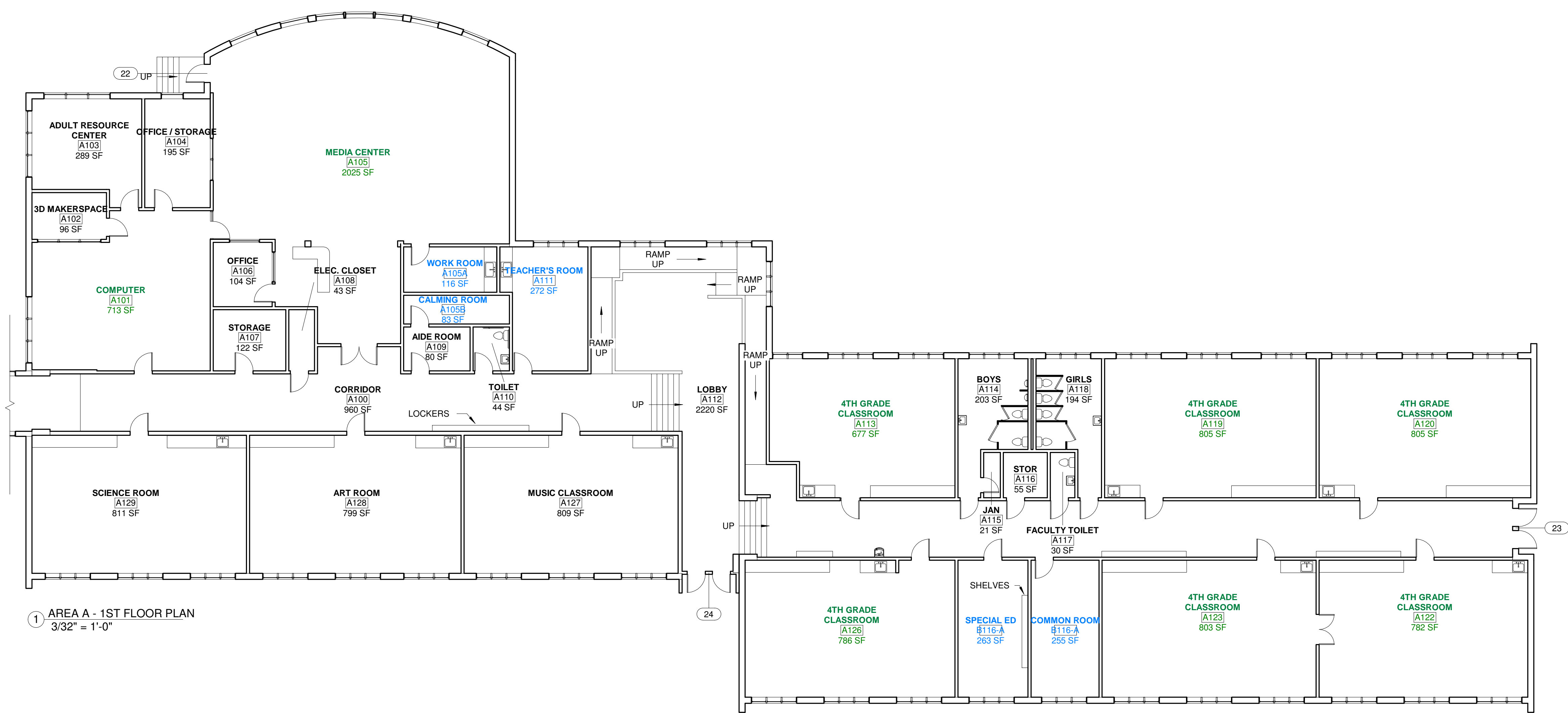

1 AREA A - 1ST FLOOR PLAN
3/32" = 1'-0"

ROOM TAG LEGEND	
ROOM NAME [RM #] AREA SQFT	ROOM TAG PROVIDED BY FACILITIES
ROOM NAME [RM #] AREA SQFT	ROOM TAG BY EXISTING CONDITIONS
ROOM NAME [RM #] AREA SQFT	ROOM TAG ASSIGNED BY SSA

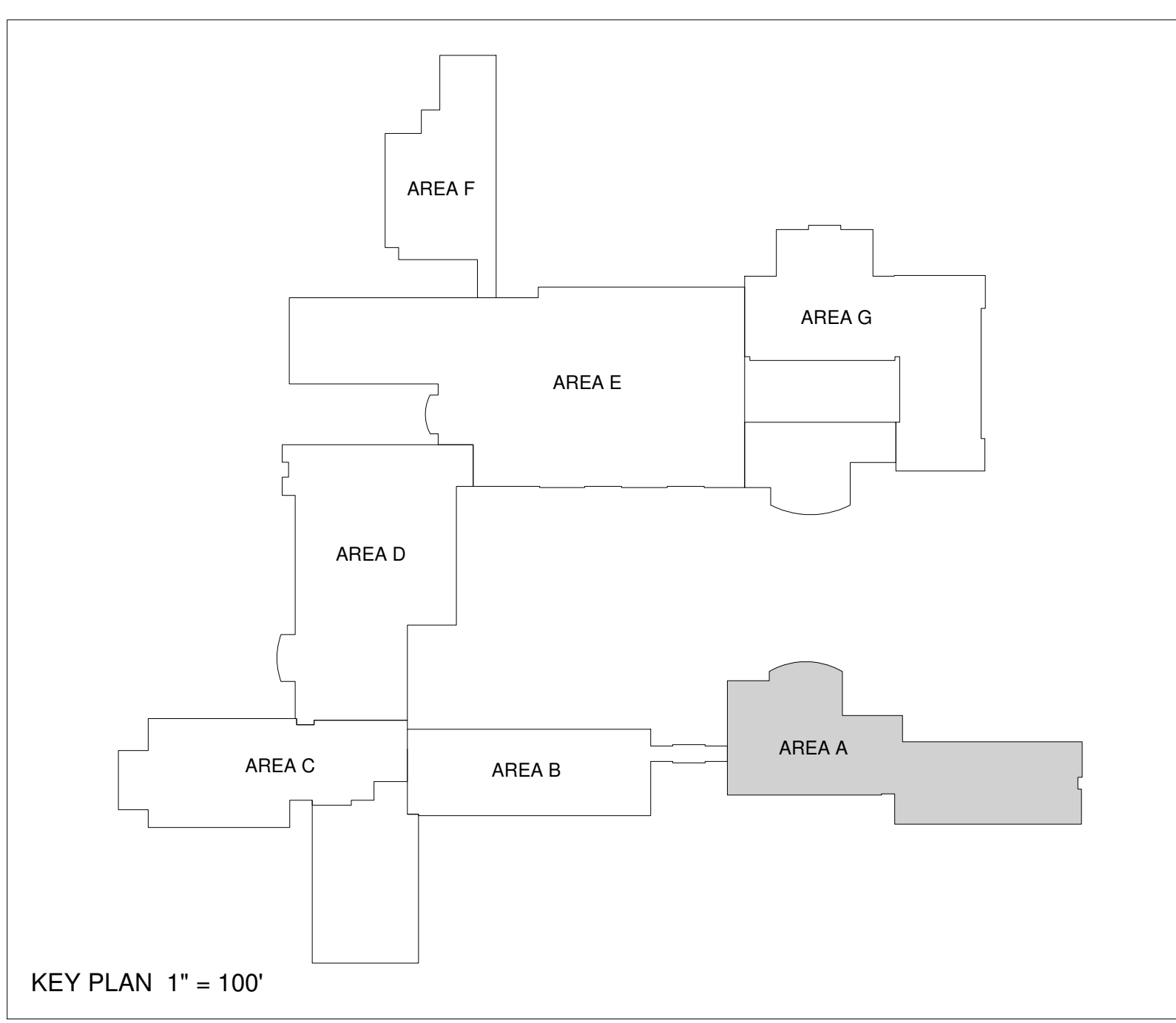

KEY PLAN 1" = 100'

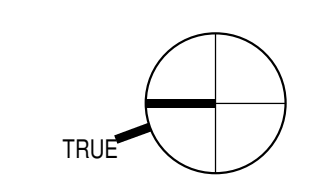

PROJECT NAME:
**CAPE ELIZABETH
ELEMENTARY
AND MIDDLE**

PROJECT LOCATION

SEAL:

**NOT FOR
CONSTRUCTION**

THIS DRAWING IS THE PROPERTY OF
SCOTT SIMONS ARCHITECTS (SSA) AND
IS NOT TO BE COPIED OR REPRODUCED
IN PART OR WHOLE.
2018 © SCOTT SIMONS ARCHITECTS, LLC

REVISIONS

DATE OF ISSUE: DATE OF ISSUE
PROJECT NUMBER: 2017-0110
STATUS: 0% PROGRESS

**AREA A - 1ST
FLOOR PLAN**

A101A



75 York Street
Portland, Maine 04101
simonsarchitects.com
207.772.4656

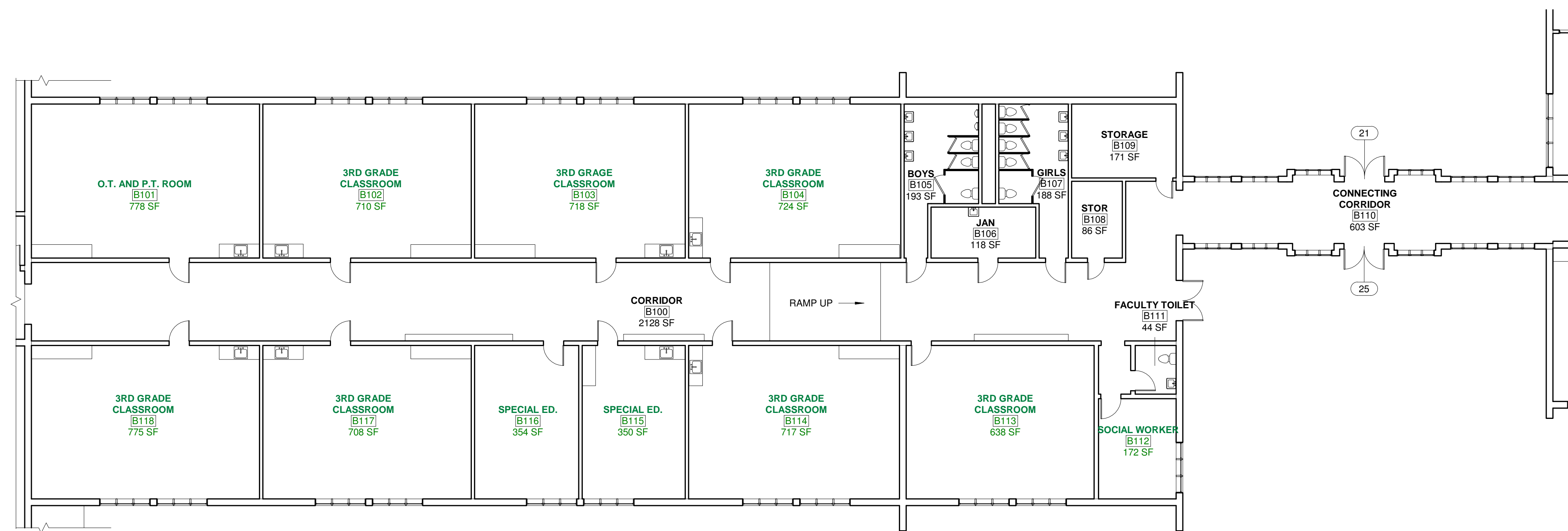

1 AREA B - 2ND FLOOR PLAN
3/32" = 1'-0"

ROOM TAG LEGEND	
ROOM NAME [RM #] AREA SQFT	ROOM TAG PROVIDED BY FACILITIES
ROOM NAME [RM #] AREA SQFT	ROOM TAG BY EXISTING CONDITIONS
ROOM NAME [RM #] AREA SQFT	ROOM TAG ASSIGNED BY SSA

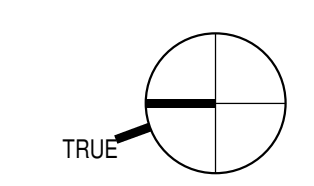

PROJECT NAME:
**CAPE ELIZABETH
ELEMENTARY
AND MIDDLE**

PROJECT LOCATION:
SEAL:

**NOT FOR
CONSTRUCTION**

THIS DRAWING IS THE PROPERTY OF
SCOTT SIMONS ARCHITECTS (SSA) AND
IS NOT TO BE COPIED OR REPRODUCED
IN PART OR WHOLE.
2018 © SCOTT SIMONS ARCHITECTS, LLC

REVISIONS

DATE OF ISSUE: DATE OF ISSUE
PROJECT NUMBER: 2017-0110
STATUS: 0% PROGRESS

**AREA B - 1ST
FLOOR PLAN**

A101B



75 York Street
Portland, Maine 04101
simonsarchitects.com
207.772.4656

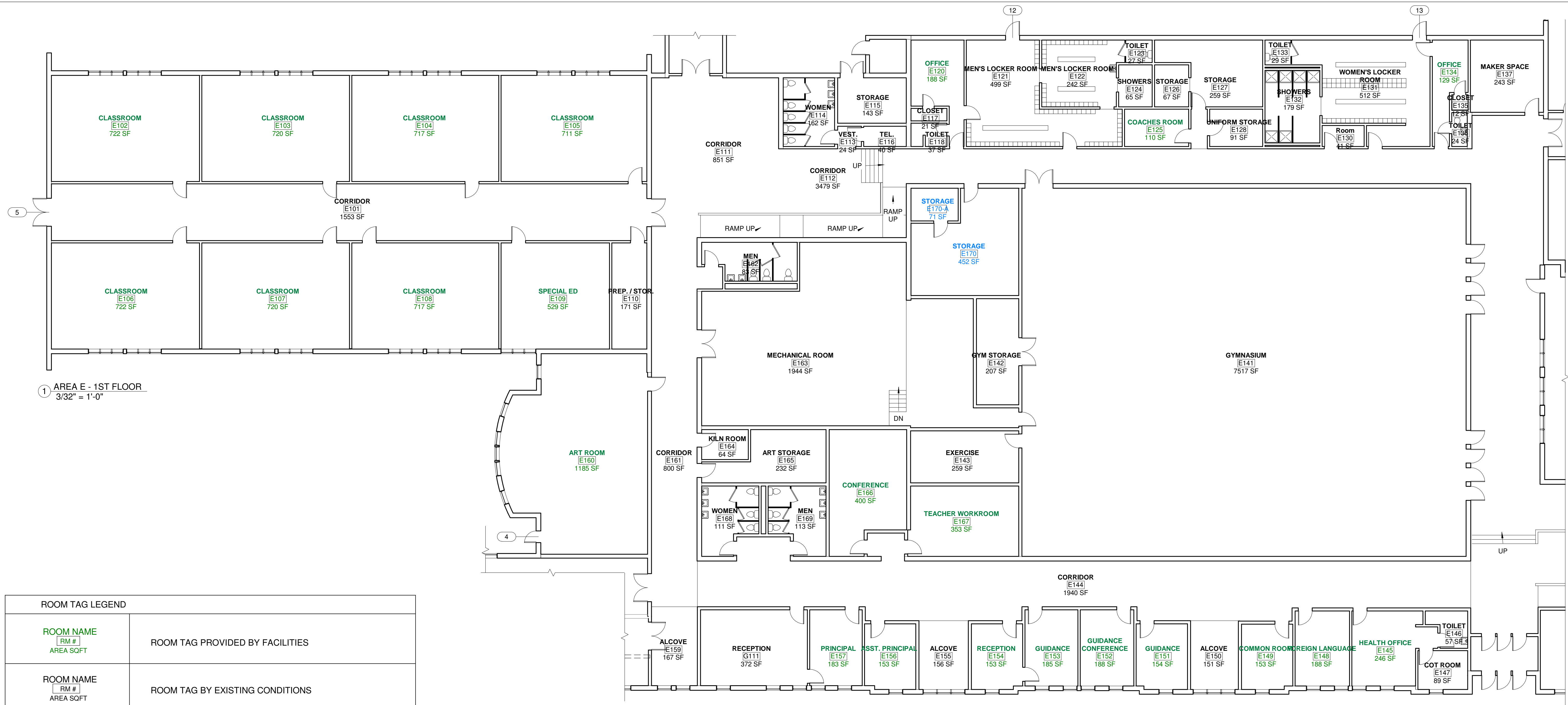

1 AREA E - 1ST FLOOR
3/32" = 1'-0"

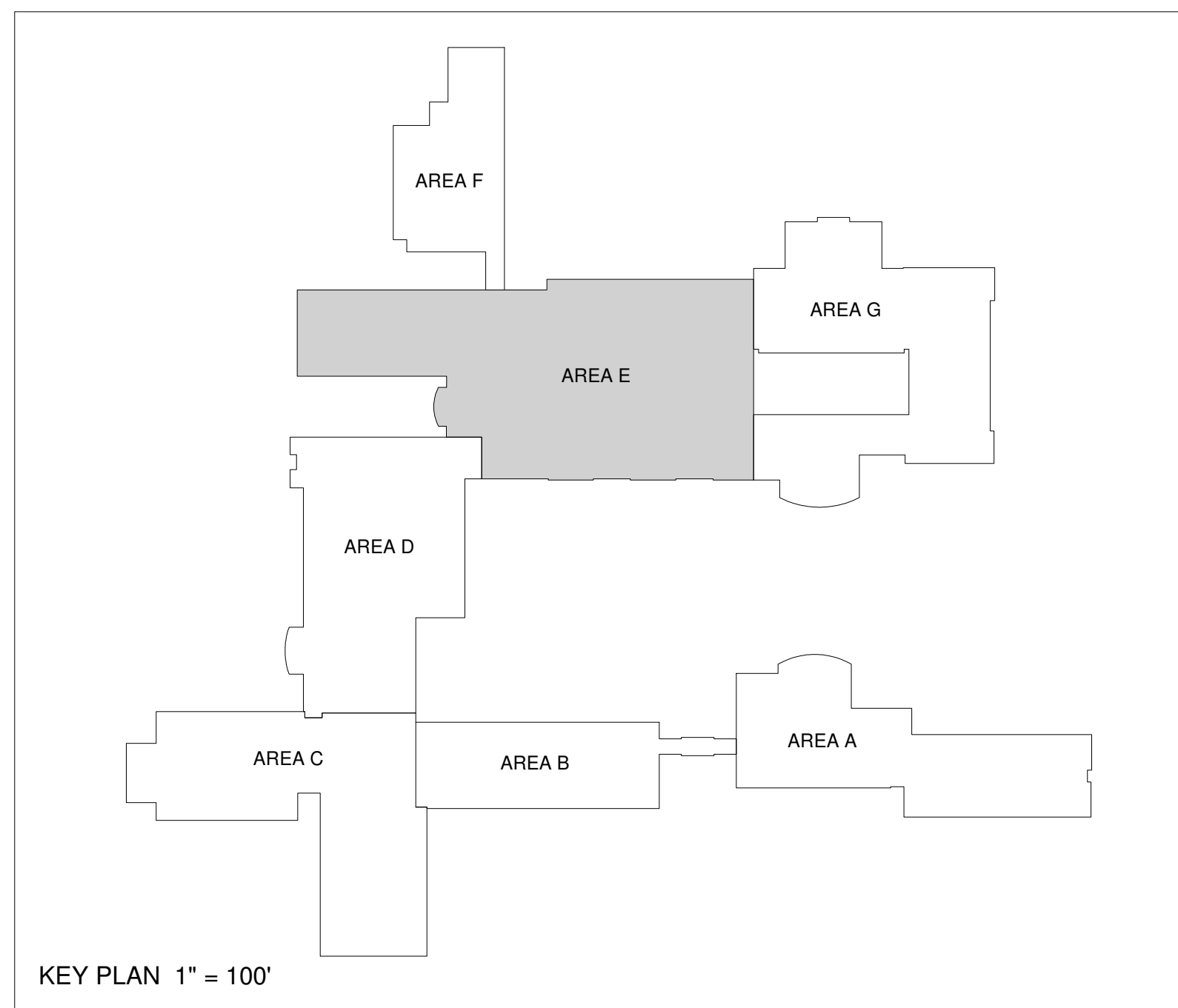

PROJECT NAME:
**CAPE ELIZABETH
ELEMENTARY
AND MIDDLE**

PROJECT LOCATION

SEAL:

**NOT FOR
CONSTRUCTION**

THIS DRAWING IS THE PROPERTY OF
SCOTT SIMONS ARCHITECTS (SSA) AND
IS NOT TO BE COPIED OR REPRODUCED
IN PART OR WHOLE.
2018 © SCOTT SIMONS ARCHITECTS, LLC

REVISIONS

DATE OF ISSUE: DATE OF ISSUE
PROJECT NUMBER: 2017-0110
STATUS: 0% PROGRESS

**AREA E - 1ST
FLOOR PLAN**

A101E

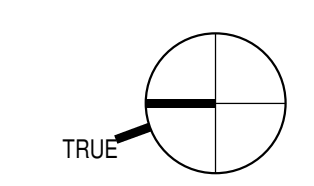

PROJECT NAME:
**CAPE ELIZABETH
ELEMENTARY
AND MIDDLE**

PROJECT LOCATION
SEAL:

**NOT FOR
CONSTRUCTION**

THIS DRAWING IS THE PROPERTY OF
SCOTT SIMONS ARCHITECTS (SSA) AND
IS NOT TO BE COPIED OR REPRODUCED
IN PART OR WHOLE.
2018 © SCOTT SIMONS ARCHITECTS, LLC

REVISIONS

DATE OF ISSUE: DATE OF ISSUE
PROJECT NUMBER: 2017-0110
STATUS: 0% PROGRESS

**AREA F - 1ST
FLOOR PLAN**

A101F

ROOM TAG LEGEND	
ROOM NAME [RM #] AREA SQFT	ROOM TAG PROVIDED BY FACILITIES
ROOM NAME [RM #] AREA SQFT	ROOM TAG BY EXISTING CONDITIONS
ROOM NAME [RM #] AREA SQFT	ROOM TAG ASSIGNED BY SSA

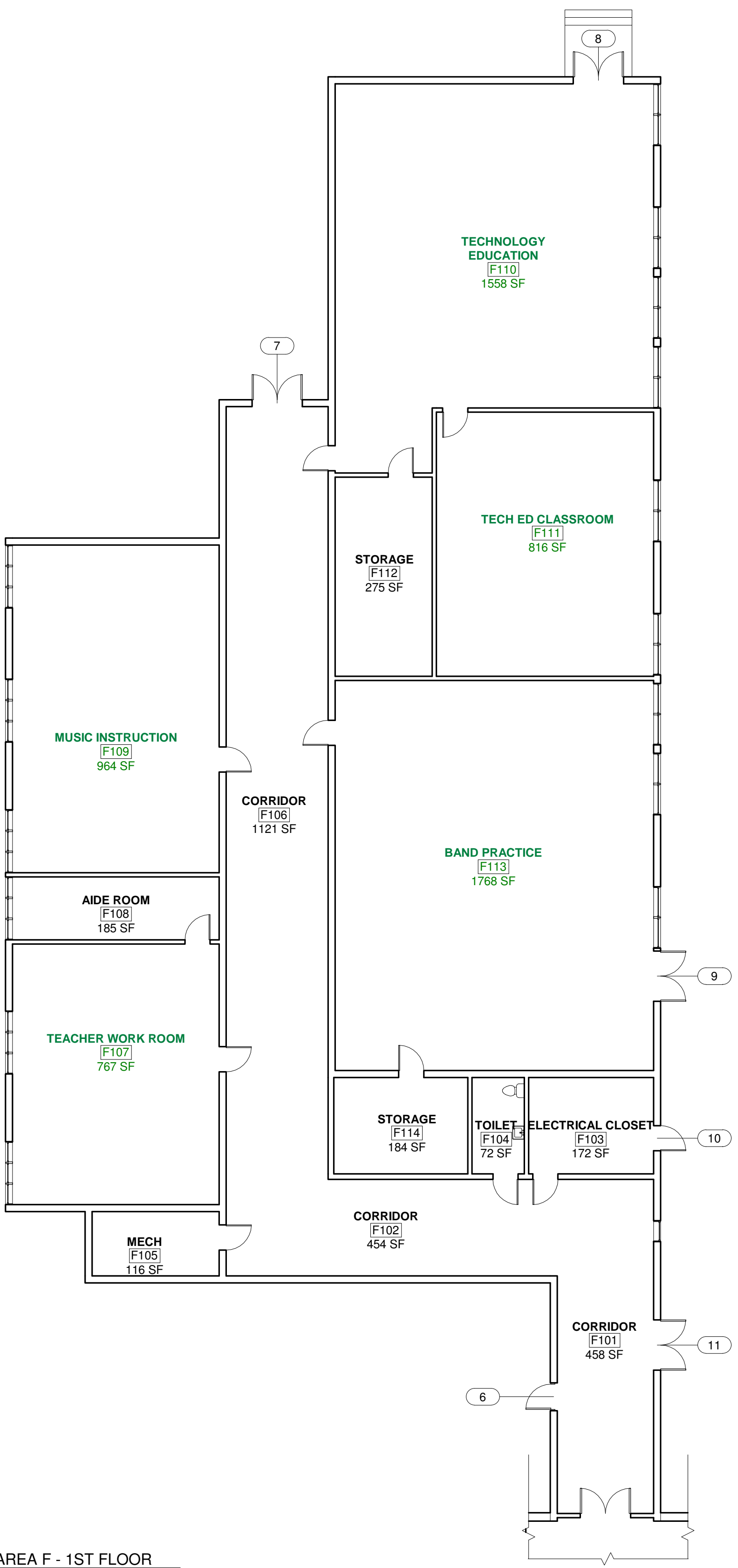
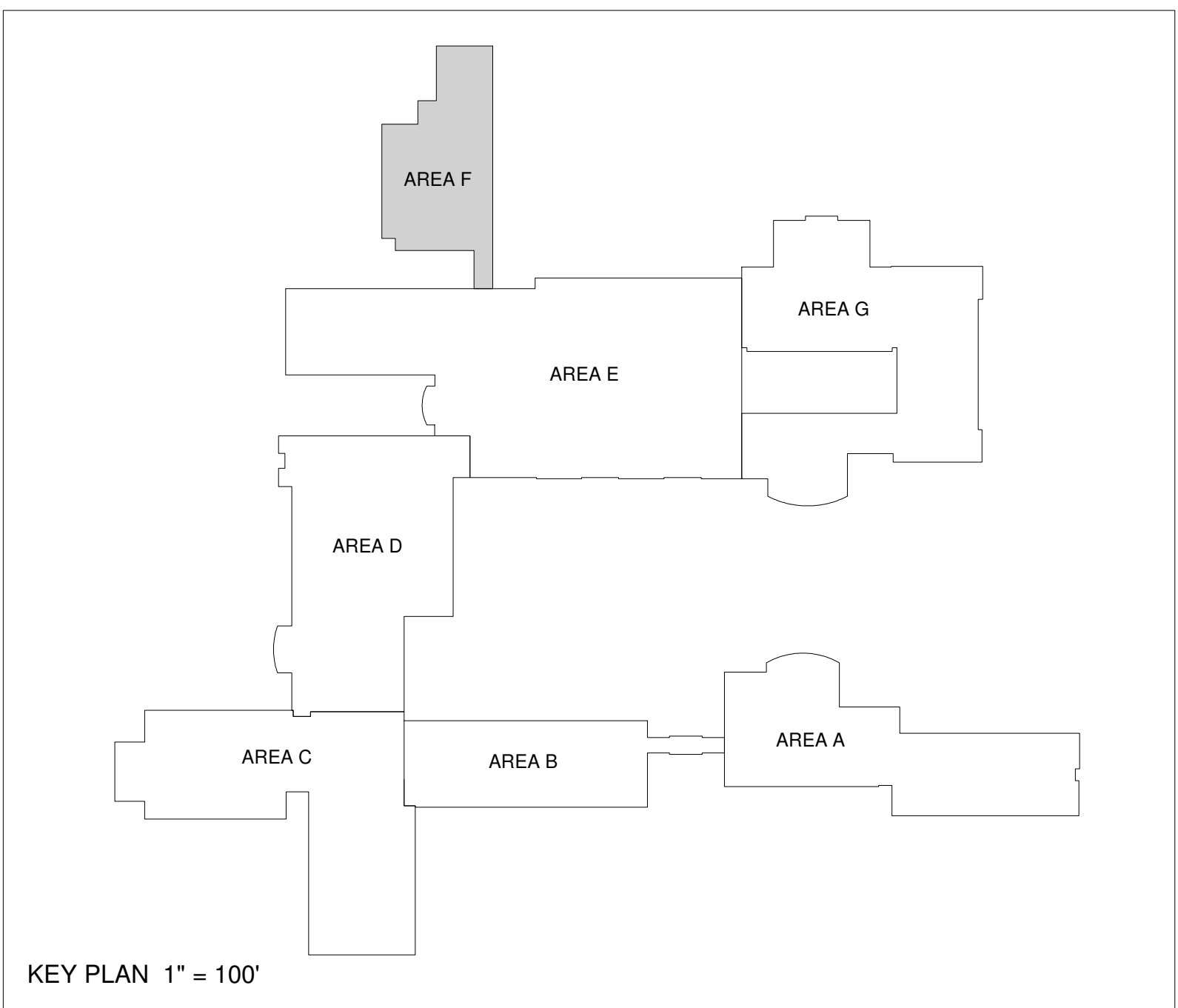

① AREA F - 1ST FLOOR
3/32" = 1'-0"

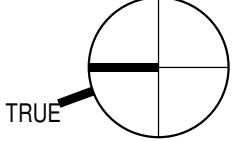

△ REVISIONS

DATE OF ISSUE: DATE OF ISSUE
PROJECT NUMBER: 2017-0110
STATUS: 0% PROGRESS

**AREA G - 1ST
FLOOR PLAN**

A101G

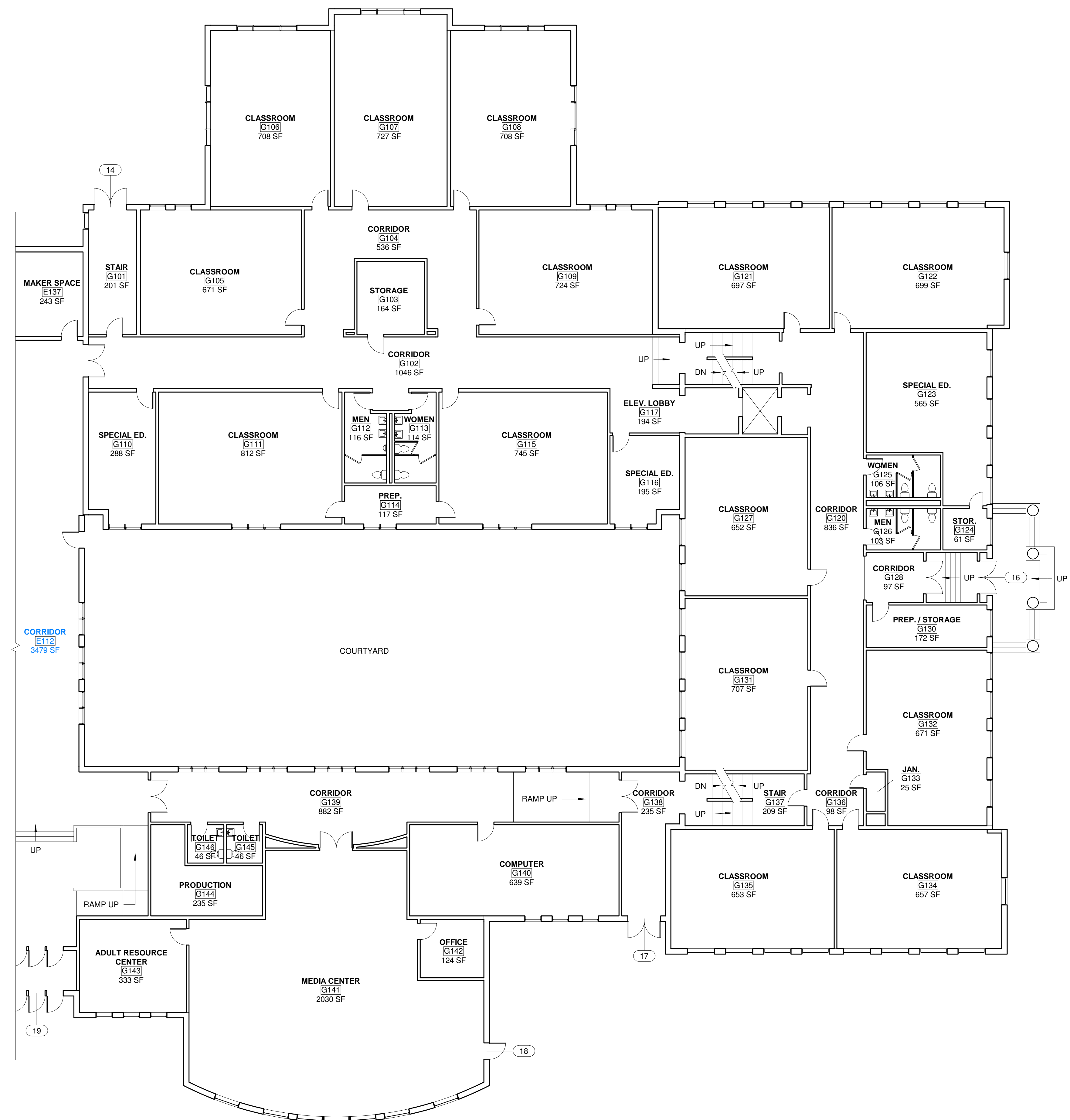

1 AREA G - 1ST FLOOR
3/32" = 1'-0"

ROOM TAG LEGEND

ROOM NAME [RM #] AREA SQFT	ROOM TAG PROVIDED BY FACILITIES
ROOM NAME [RM #] AREA SQFT	ROOM TAG BY EXISTING CONDITIONS
ROOM NAME [RM #] AREA SQFT	ROOM TAG ASSIGNED BY SSA

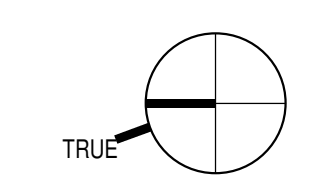
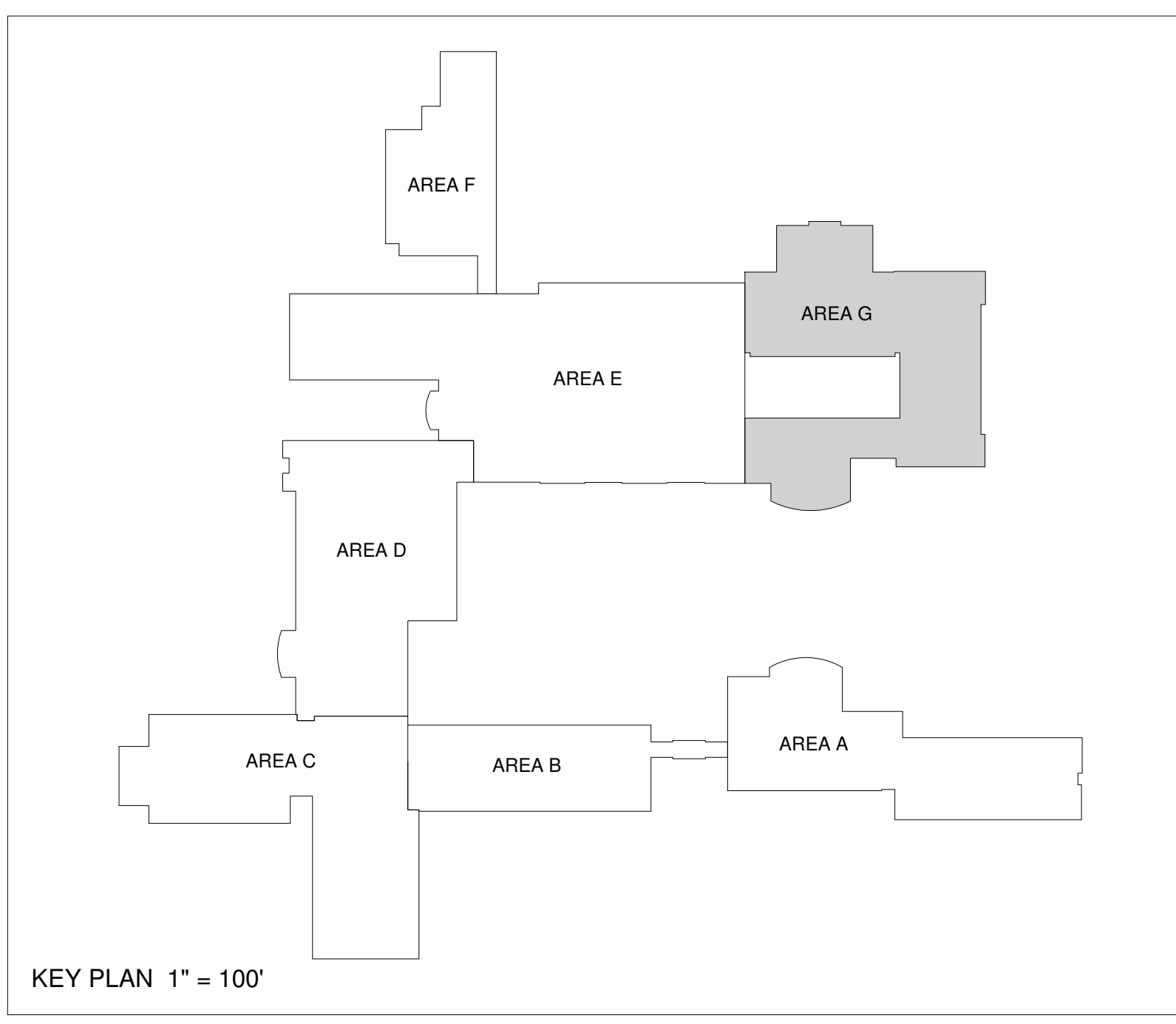



75 York Street
Portland, Maine 04101
simonsarchitects.com
207.772.4656



① AREA C - 2ND FLOOR PLAN
3/32" = 1'-0"

ROOM TAG LEGEND	
ROOM NAME [RM #] AREA SQFT	ROOM TAG PROVIDED BY FACILITIES
ROOM NAME [RM #] AREA SQFT	ROOM TAG BY EXISTING CONDITIONS
ROOM NAME [RM #] AREA SQFT	ROOM TAG ASSIGNED BY SSA

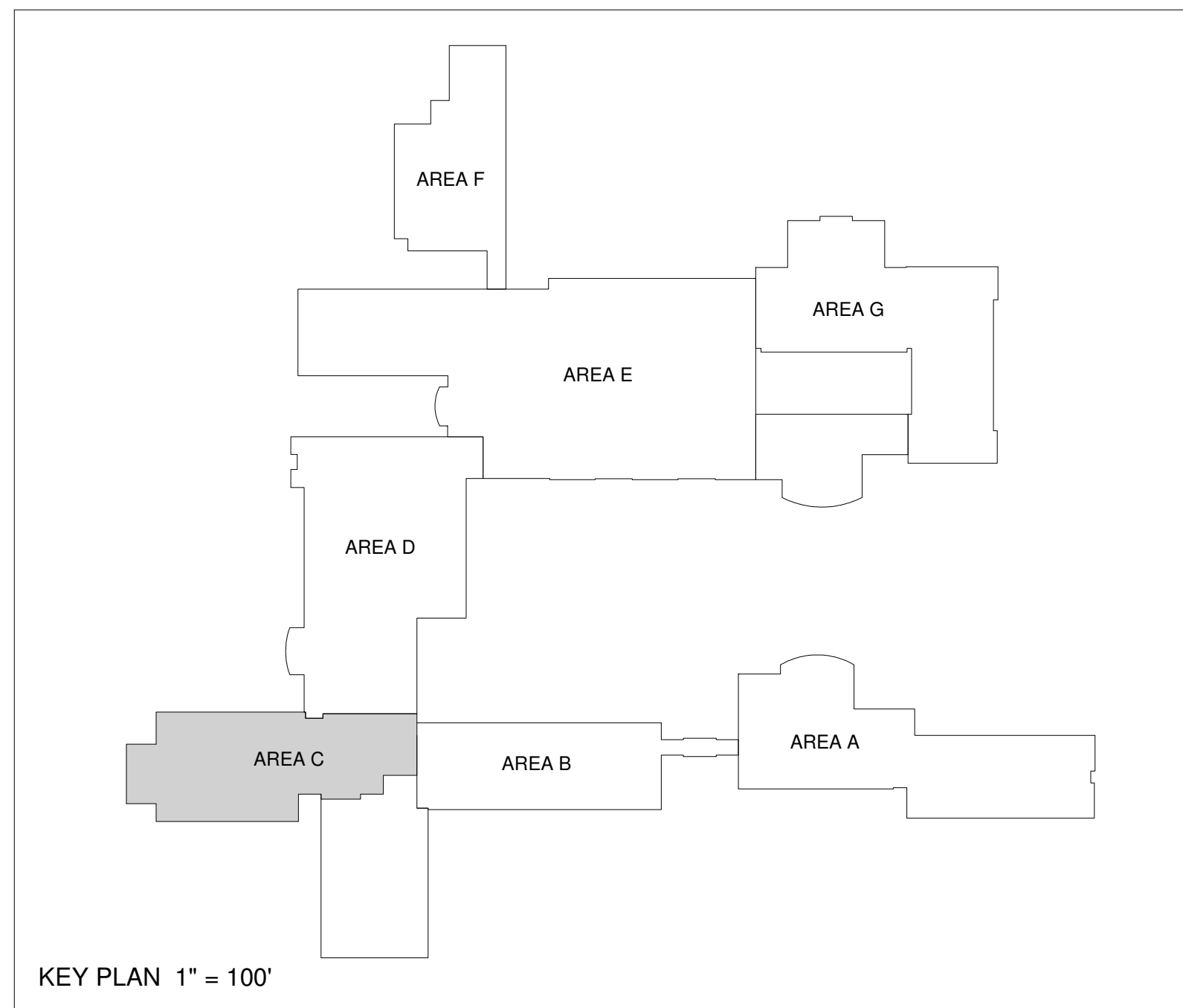

KEY PLAN 1" = 100'

PROJECT NAME:
**CAPE ELIZABETH
ELEMENTARY
AND MIDDLE**

PROJECT LOCATION

SEAL:

**NOT FOR
CONSTRUCTION**

THIS DRAWING IS THE PROPERTY OF
SCOTT SIMONS ARCHITECTS (SSA) AND
IS NOT TO BE COPIED OR REPRODUCED
IN PART OR WHOLE.
2018 © SCOTT SIMONS ARCHITECTS, LLC

△ REVISIONS

DATE OF ISSUE: DATE OF ISSUE

PROJECT NUMBER: 2017-0110

STATUS: 0% PROGRESS

**AREA C - 2ND
FLOOR PLAN**

A102C

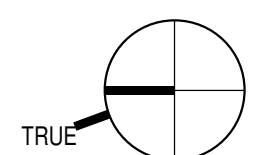



75 York Street
 Portland, Maine 04101
 simonsarchitects.com
 207.772.4656

PROJECT NAME:
**CAPE ELIZABETH
 ELEMENTARY
 AND MIDDLE**

PROJECT LOCATION

SEAL:

**NOT FOR
 CONSTRUCTION**

THIS DRAWING IS THE PROPERTY OF
 SCOTT SIMONS ARCHITECTS (SSA) AND
 IS NOT TO BE COPIED OR REPRODUCED
 IN PART OR WHOLE.
 2018 © SCOTT SIMONS ARCHITECTS, LLC

△ REVISIONS

DATE OF ISSUE: DATE OF ISSUE

PROJECT NUMBER: 2017-0110

STATUS: 0% PROGRESS

**AREA G - 2ND
 FLOOR PLAN**

A102G



① AREA G - 2ND FLOOR PLAN
 3/32" = 1'-0"

ROOM TAG LEGEND	
ROOM NAME [RM #] AREA SQFT	ROOM TAG PROVIDED BY FACILITIES
ROOM NAME [RM #] AREA SQFT	ROOM TAG BY EXISTING CONDITIONS
ROOM NAME [RM #] AREA SQFT	ROOM TAG ASSIGNED BY SSA

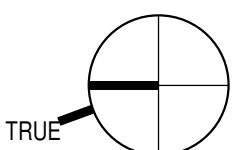
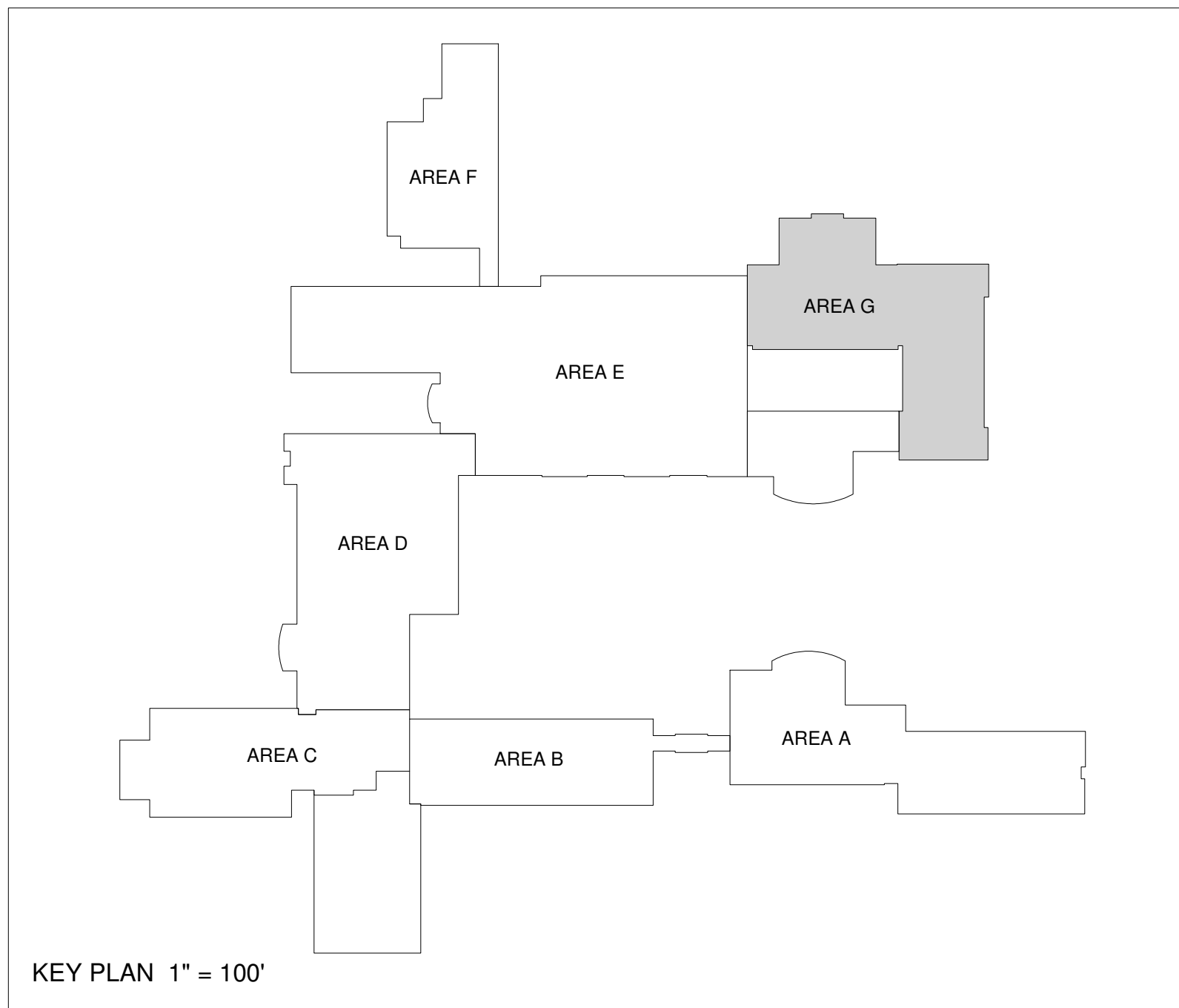



75 York Street
Portland, Maine 04101
simonsarchitects.com
207.772.4656

PROJECT NAME:
**CAPE ELIZABETH
ELEMENTARY
AND MIDDLE**

PROJECT LOCATION

SEAL:

THIS DRAWING IS THE PROPERTY OF
SCOTT SIMONS ARCHITECTS (SSA) AND
IS NOT TO BE COPIED OR REPRODUCED
IN PART OR WHOLE.
2018 © SCOTT SIMONS ARCHITECTS, LLC

REVISIONS

DATE OF ISSUE: DATE OF ISSUE

PROJECT NUMBER: 2017-0110

STATUS: 0% PROGRESS

**1ST FLOOR - C
PLAN**

A101A

ROOM TAG LEGEND	
ROOM NAME [RM #] AREA SQFT	ROOM TAG PROVIDED BY FACILITIES
ROOM NAME [RM #] AREA SQFT	ROOM TAG BY EXISTING CONDITIONS
ROOM NAME [RM #] AREA SQFT	ROOM TAG ASSIGNED BY SSA

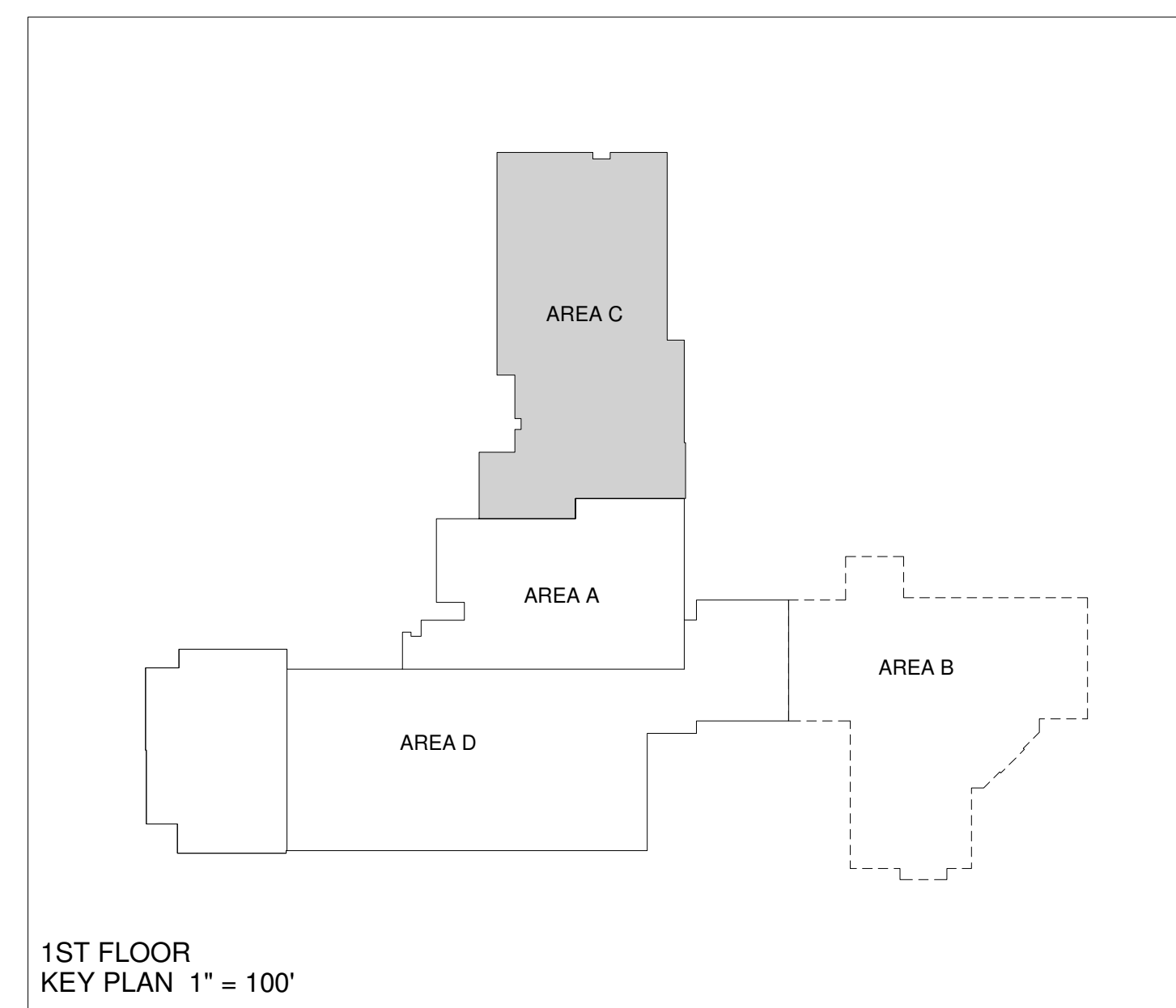

1 1ST FLOOR - C PLAN
3/32" = 1'-0"



FIRST FLOOR - AREA C
FIRST FLOOR - AREA A

ROOM TAG LEGEND	
ROOM NAME RM # AREA SQFT	ROOM TAG PROVIDED BY FACILITIES
ROOM NAME RM # AREA SQFT	ROOM TAG BY EXISTING CONDITIONS
ROOM NAME RM # AREA SQFT	ROOM TAG ASSIGNED BY SSA

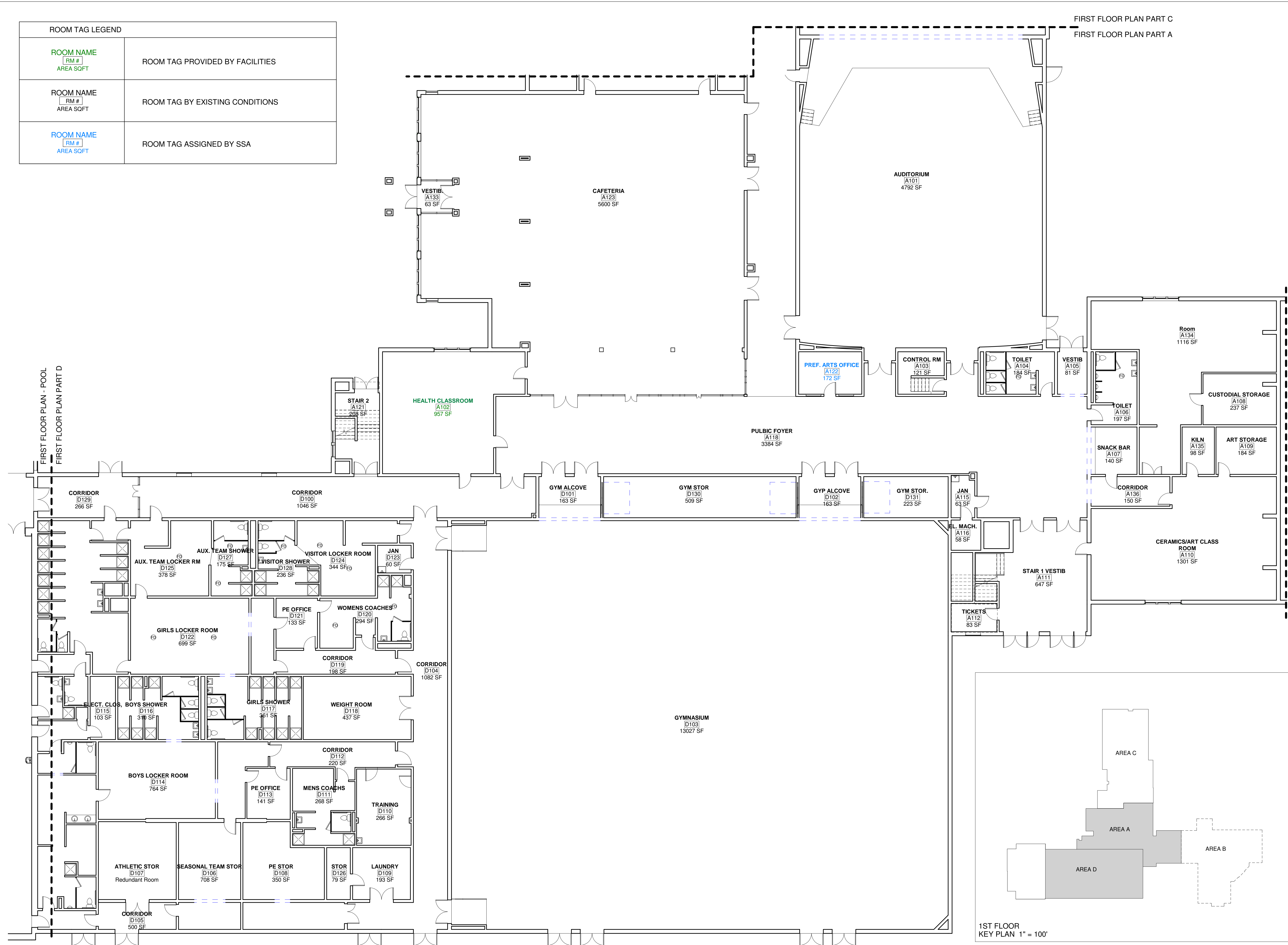

FIRST FLOOR PLAN PART C
FIRST FLOOR PLAN PART A



75 York Street
Portland, Maine 04101
simonsarchitects.com
207.772.4656

PROJECT NAME:
**CAPE ELIZABETH
ELEMENTARY
AND MIDDLE**

PROJECT LOCATION:
SEAL:

THIS DRAWING IS THE PROPERTY OF
SCOTT SIMONS ARCHITECTS (SSA) AND
IS NOT TO BE COPIED OR REPRODUCED
IN PART OR WHOLE.
2018 © SCOTT SIMONS ARCHITECTS, LLC

REVISIONS

NO.	DESCRIPTION

DATE OF ISSUE: DATE OF ISSUE
PROJECT NUMBER: 2017-0110
STATUS: 0% PROGRESS

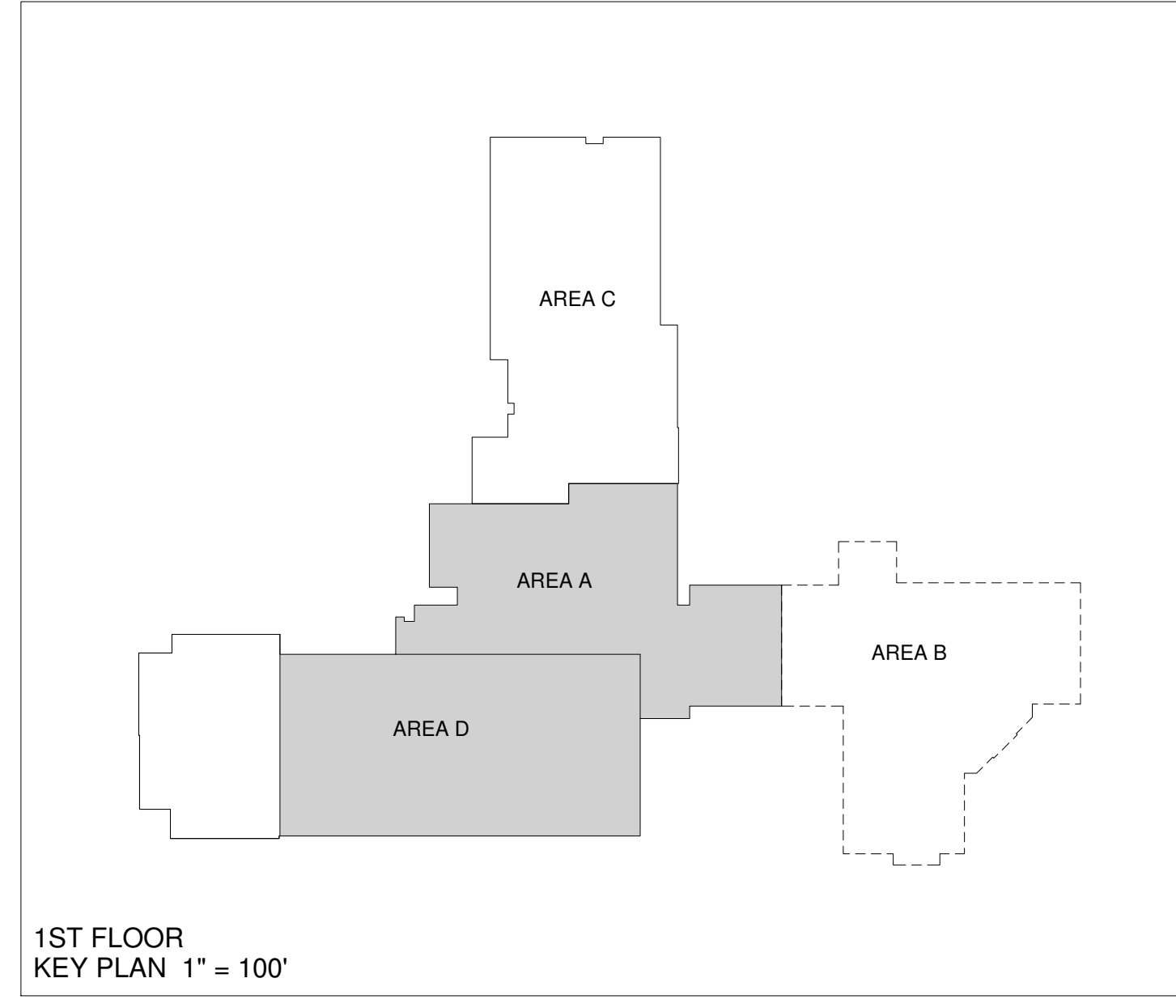

1ST FLOOR
KEY PLAN 1" = 100'

**FIRST FLOOR - A
& D PLAN**

A101B



75 York Street
Portland, Maine 04101
simonsarchitects.com
207.772.4656

SECOND FLOOR PLAN AREA A
SECOND FLOOR PLAN AREA B



1 2ND FLOOR - B PLAN
3/32" = 1'-0"

ROOM TAG LEGEND	
ROOM NAME [RM #] AREA SQFT	ROOM TAG PROVIDED BY FACILITIES
ROOM NAME [RM #] AREA SQFT	ROOM TAG BY EXISTING CONDITIONS
ROOM NAME [RM #] AREA SQFT	ROOM TAG ASSIGNED BY SSA

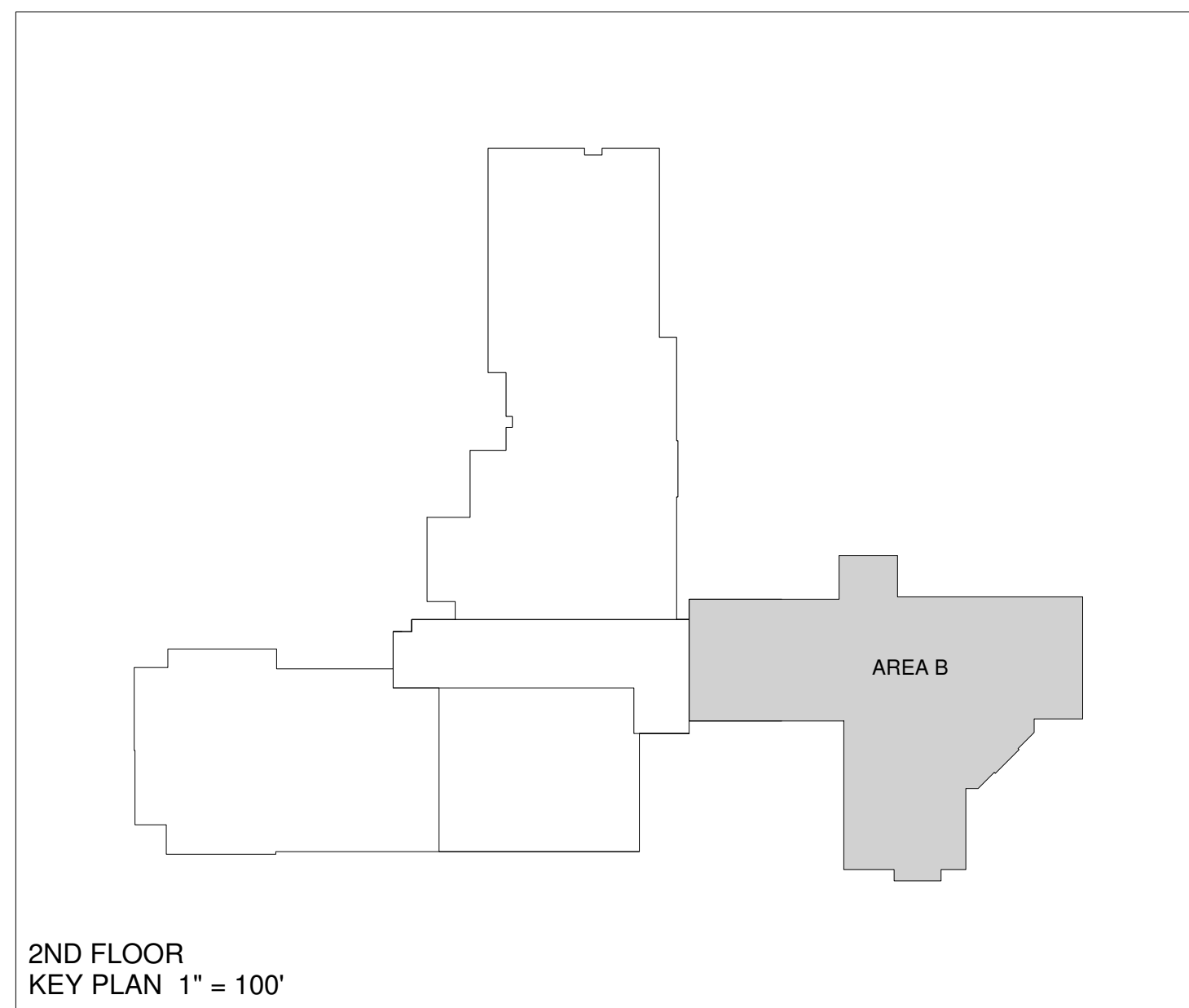

PROJECT NAME:
**CAPE ELIZABETH
ELEMENTARY
AND MIDDLE**

PROJECT LOCATION:
SEAL:

THIS DRAWING IS THE PROPERTY OF
SCOTT SIMONS ARCHITECTS (SSA) AND
IS NOT TO BE COPIED OR REPRODUCED
IN PART OR WHOLE.
2018 © SCOTT SIMONS ARCHITECTS, LLC

△ REVISIONS

DATE OF ISSUE: DATE OF ISSUE
PROJECT NUMBER: 2017-0110
STATUS: 0% PROGRESS

**2ND FLOOR - B
PLAN**

A102D

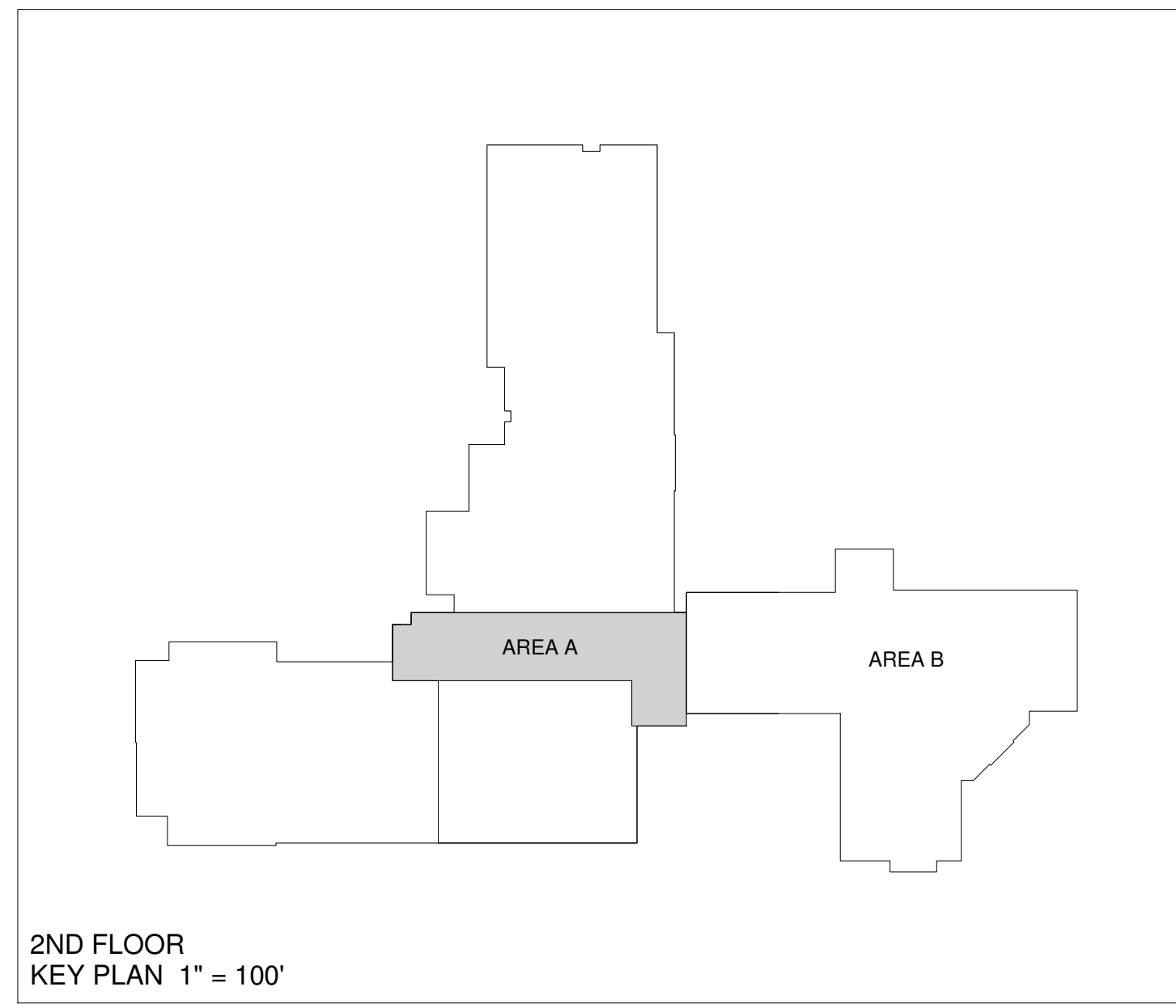

2ND FLOOR
KEY PLAN 1" = 100'

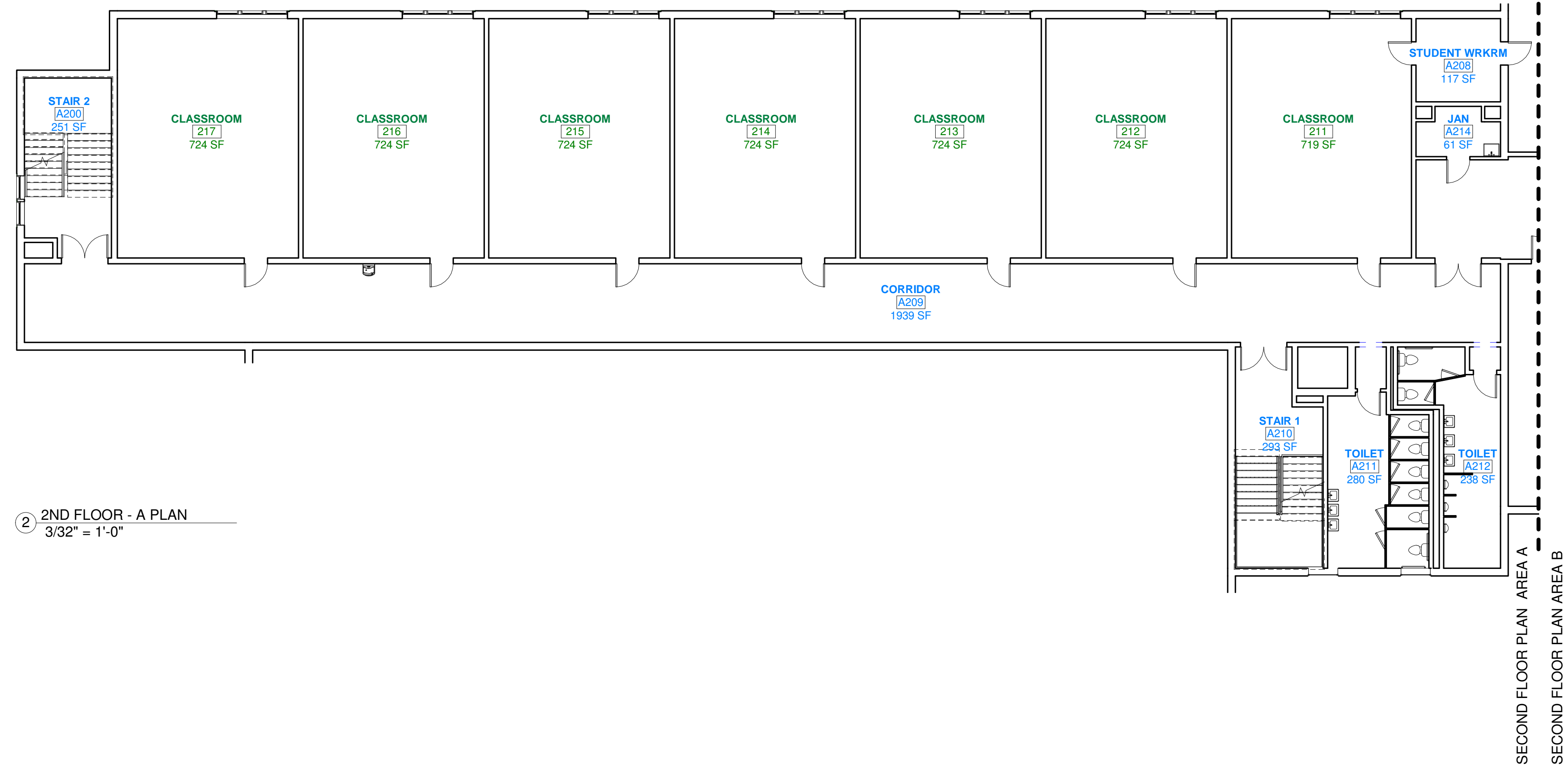

2 2ND FLOOR - A PLAN
3/32" = 1'-0"

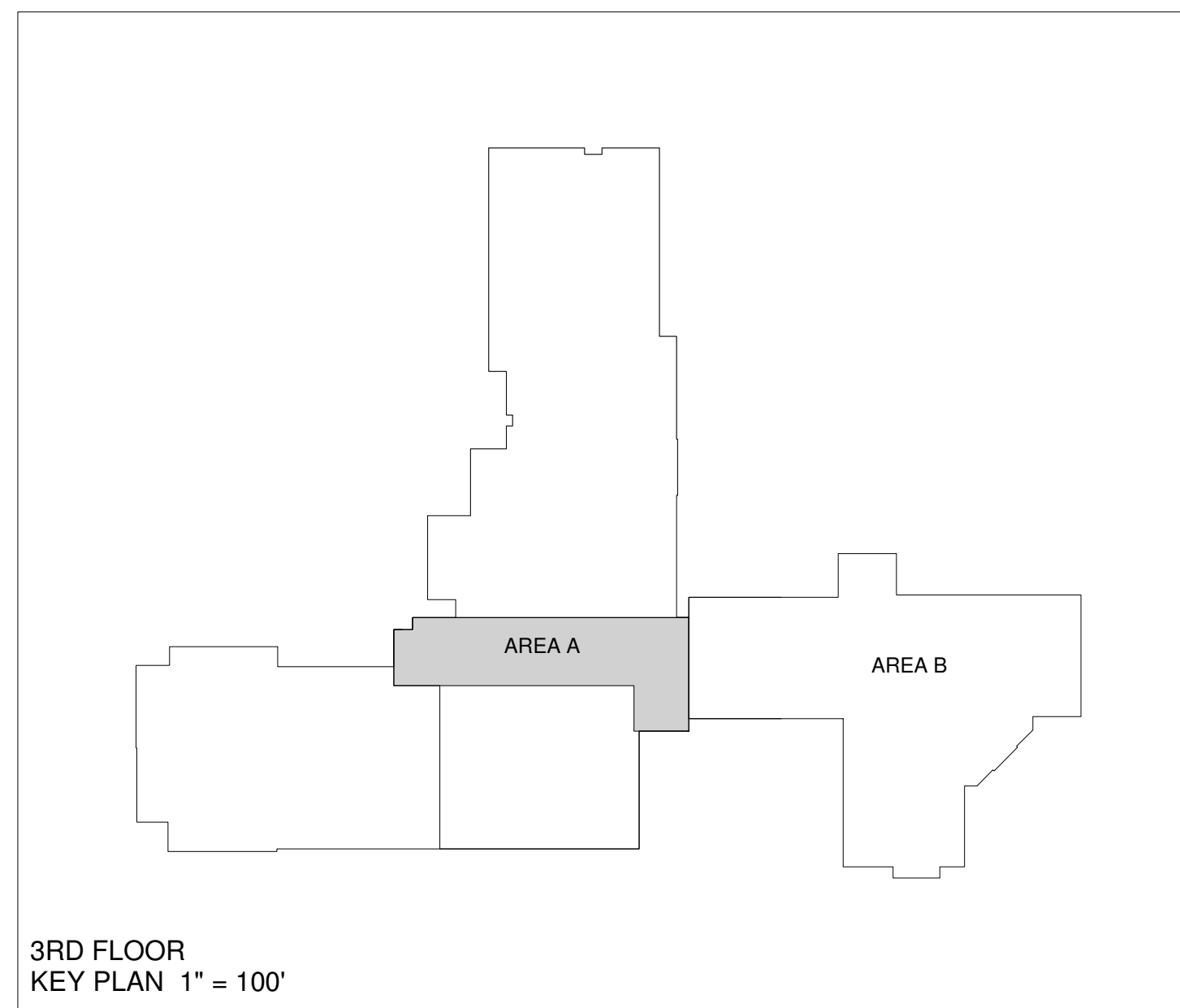

3RD FLOOR
KEY PLAN 1" = 100'

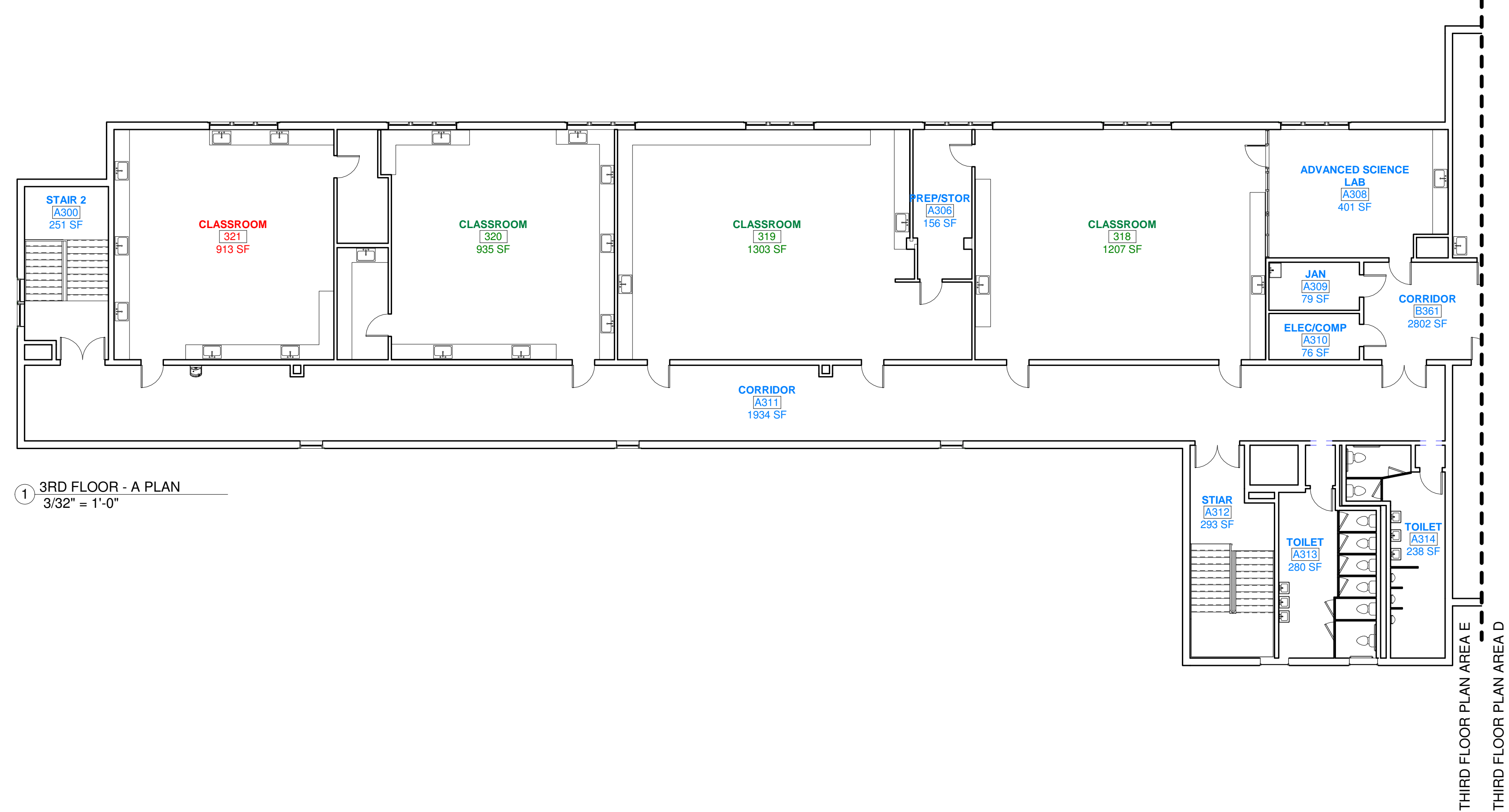

1 3RD FLOOR - A PLAN
3/32" = 1'-0"

ROOM TAG LEGEND	
ROOM NAME [RM #] AREA SOFT	ROOM TAG PROVIDED BY FACILITIES
ROOM NAME [RM #] AREA SOFT	ROOM TAG BY EXISTING CONDITIONS
ROOM NAME [RM #] AREA SOFT	ROOM TAG ASSIGNED BY SSA



75 York Street
Portland, Maine 04101
simonsarchitects.com
207.772.4656

PROJECT NAME:
**CAPE ELIZABETH
ELEMENTARY
AND MIDDLE**

PROJECT LOCATION

SEAL:

THIS DRAWING IS THE PROPERTY OF
SCOTT SIMONS ARCHITECTS (SSA) AND
IS NOT TO BE COPIED OR REPRODUCED
IN PART OR WHOLE.
2018 © SCOTT SIMONS ARCHITECTS, LLC

REVISIONS

DATE OF ISSUE: DATE OF ISSUE

PROJECT NUMBER: 2017-0110

STATUS: 0% PROGRESS

**2ND AND 3RD
FLOOR PLANS**

A102E



75 York Street
Portland, Maine 04101
simonsarchitects.com
207.772.4656

THIRD FLOOR PLAN - 300'S
THIRD FLOOR PLAN AREA B



① 3RD FLOOR - B PLAN
3/32" = 1'-0"

ROOM TAG LEGEND	
ROOM NAME RM # AREA SQFT	ROOM TAG PROVIDED BY FACILITIES
ROOM NAME RM # AREA SQFT	ROOM TAG BY EXISTING CONDITIONS
ROOM NAME RM # AREA SQFT	ROOM TAG ASSIGNED BY SSA

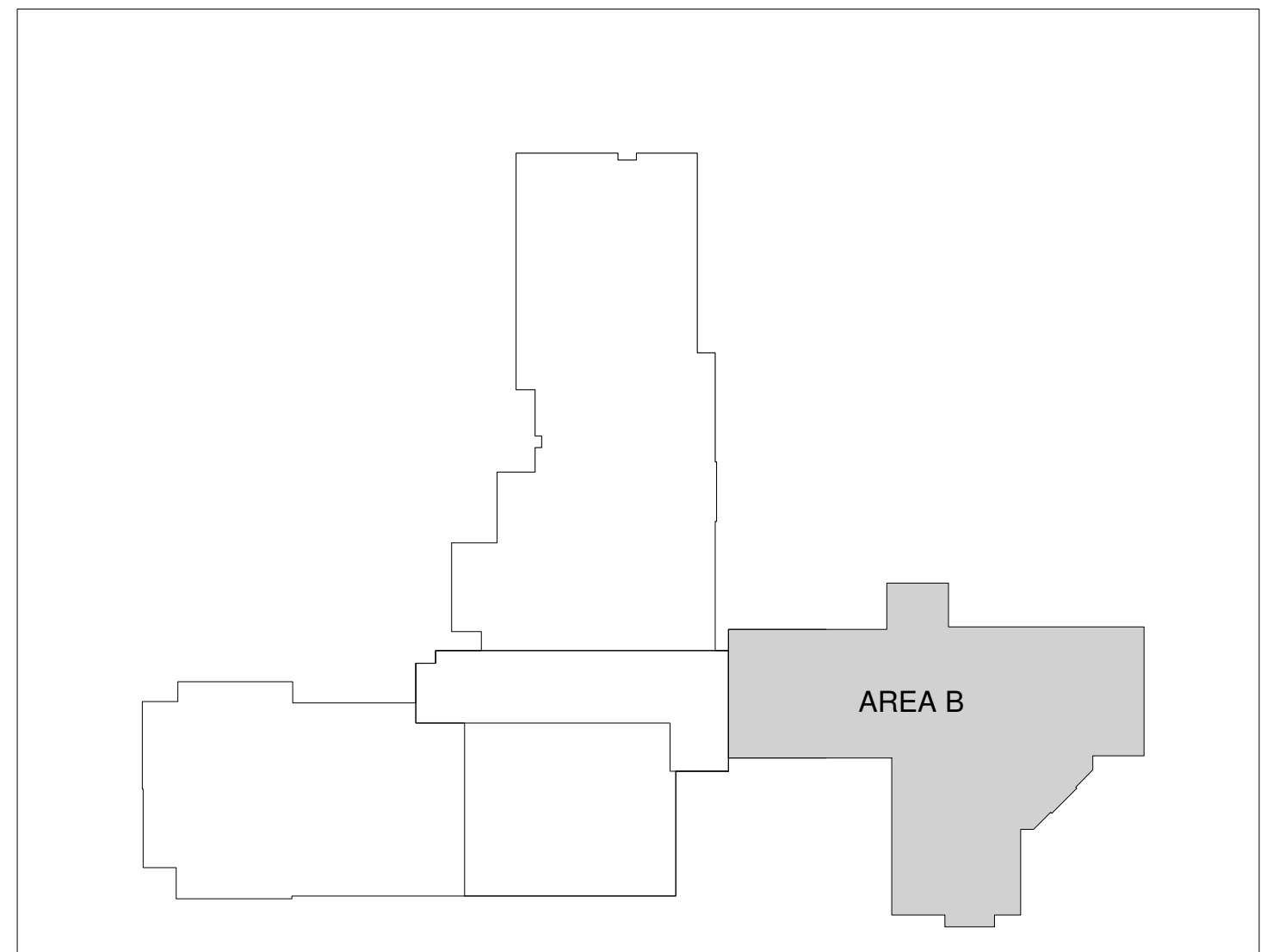

3RD FLOOR
KEY PLAN 1" = 100'

PROJECT NAME:
**CAPE ELIZABETH
ELEMENTARY
AND MIDDLE**

PROJECT LOCATION

SEAL:

THIS DRAWING IS THE PROPERTY OF
SCOTT SIMONS ARCHITECTS (SSA) AND
IS NOT TO BE COPIED OR REPRODUCED
IN PART OR WHOLE.
2018 © SCOTT SIMONS ARCHITECTS, LLC

REVISIONS

DATE OF ISSUE: DATE OF ISSUE
PROJECT NUMBER: 2017-0110
STATUS: 0% PROGRESS

**3RD FLOOR -
PART B PLAN**

A103D

APPENDIX G – NEIGHBORING DISTRICT COMPARISONS



Neighboring Districition Comparisons - This is a compiled list of publicly available information with regard to large capital school projects in neighboring districts. This list is a 95% draft and will be finalized for the 100% final submission.

Town	School	Project Type	Date	Total Project Cost	State Funds	Municipal Funds	Other Funds	Notes
Falmouth	Elementary School	New School	2011	\$ 37,700,000	\$ 31,700,000	\$ 6,000,000		
Falmouth	Middle/High School	Security Upgrades	2017	\$ 300,000	\$ 300,000			
RSU 5 (Freeport, Durham, Pownal)	Freeport High School	Renovations	2013	\$ 14,600,000	\$ -	\$ 14,600,000		
RSU 5 (Freeport, Durham, Pownal)	Freeport High School	Track and Field Complex	2017	\$ 4,500,000	\$ -	\$ 2,053,955	\$ 2,300,000	\$2.3M raised by Tri-Town Track & Field Project, complex completed May 2018
Scarborough	Wentworth Elementary School	New school	2014	\$ 40,000,000	\$ -	\$ 40,000,000		
South Portland	High School	Electrical/Fire Upgrades, Renovations	2015	\$ 47,300,000		\$ 5,800,000	\$ 41,500,000	Renovations began in 2012, renovations completed Jan 2015
Westbrook	Elementary/Middle School	Renovations/Additions to both schools	2016			\$ 2,700,000		
Westbrook	Middle School	New School	2010	\$ 29,000,000	\$ 26,100,000	\$ 2,900,000		90% state funded
Westbrook	Middle School	New auditorum add-on	2007	\$ 4,100,000		\$ 4,100,000		
Yarmouth	All 4 schools	expansion of all 4 schools, complete renovation of Elementary	2018	\$ 48,300,000				Taxpayers approved two 30-year bond financing plans in the amounts of \$39.8 million and \$8.5 million
Portland	Elementary School	Harrison Lyseth Renovation	2019	\$ 15,300,000				Total cost is estimated, project just began, project is part of \$64.4M bond to renovate 4 elementary schools
Gorham	Elementary School	New School	2011	\$ 20,000,000				
Kennebunk	High School	Additions and Renovations	2018	\$ 42,800,000				
Topsham	High School	New School	2020	\$ 60,704,671		\$ 6,200,000		Construction is ongoing, estimated school opening Fall 2020